

SEATING CAPACITY	
NORMAL	12
COVID	12



**MINNESOTA STATE UNIVERSITY**  
MANKATO  
**PLANNING & CONSTRUCTION**

**7700 FRANCE 512**  
COVID SEATING LAYOUT  
3' SOCIAL DISTANCE

DRAWN BY: N. HUETTL March 2021

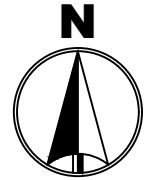

515A

515B

FE

514

512

511

506

502

510-1

510-4

507

<b>SEATING CAPACITY</b>	
NORMAL	12
COVID	8

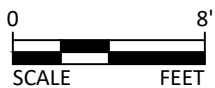

**MINNESOTA STATE UNIVERSITY**  
MANKATO  
**PLANNING & CONSTRUCTION**

**7700 FRANCE 513**  
COVID SEATING LAYOUT  
3' SOCIAL DISTANCE

DRAWN BY: N. HUETTL

March 2021

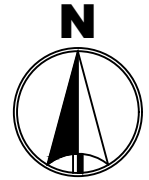

515B

FE

513

511

TEACHING STATION

6

10-1

510-4

507

SEATING CAPACITY	
NORMAL	18
COVID	13

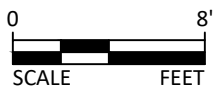

MINNESOTA STATE  
UNIVERSITY  
MANKATO  
PLANNING & CONSTRUCTION

7700 FRANCE 514  
COVID SEATING LAYOUT  
3' SOCIAL DISTANCE

DRAWN BY: N. HUETTL

March 2021

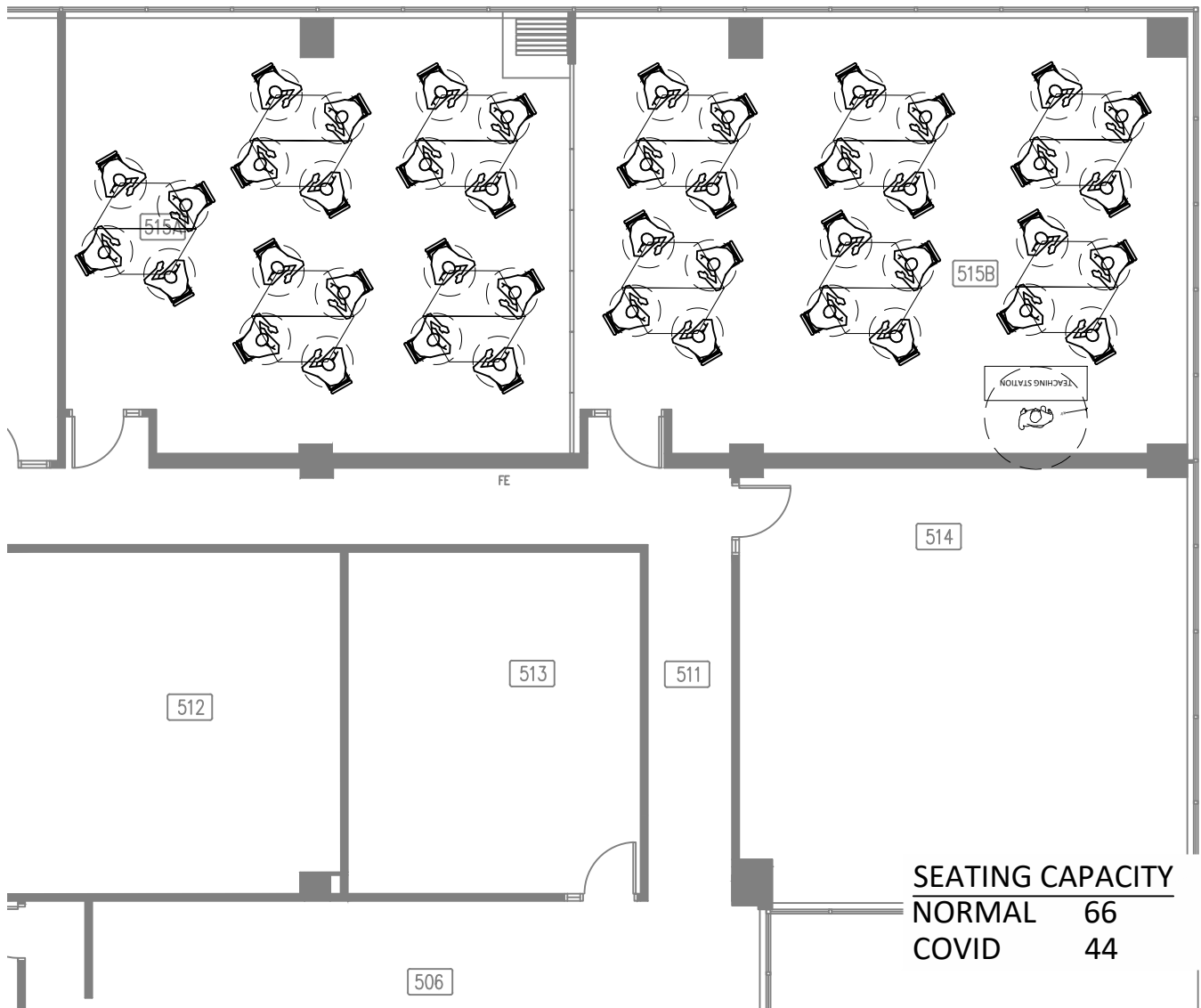

MINNESOTA STATE  
UNIVERSITY  
MANKATO  
PLANNING & CONSTRUCTION

7700 FRANCE 515A/B  
COVID SEATING LAYOUT  
3' SOCIAL DISTANCE

DRAWN BY: N. HUETTL

March 2021



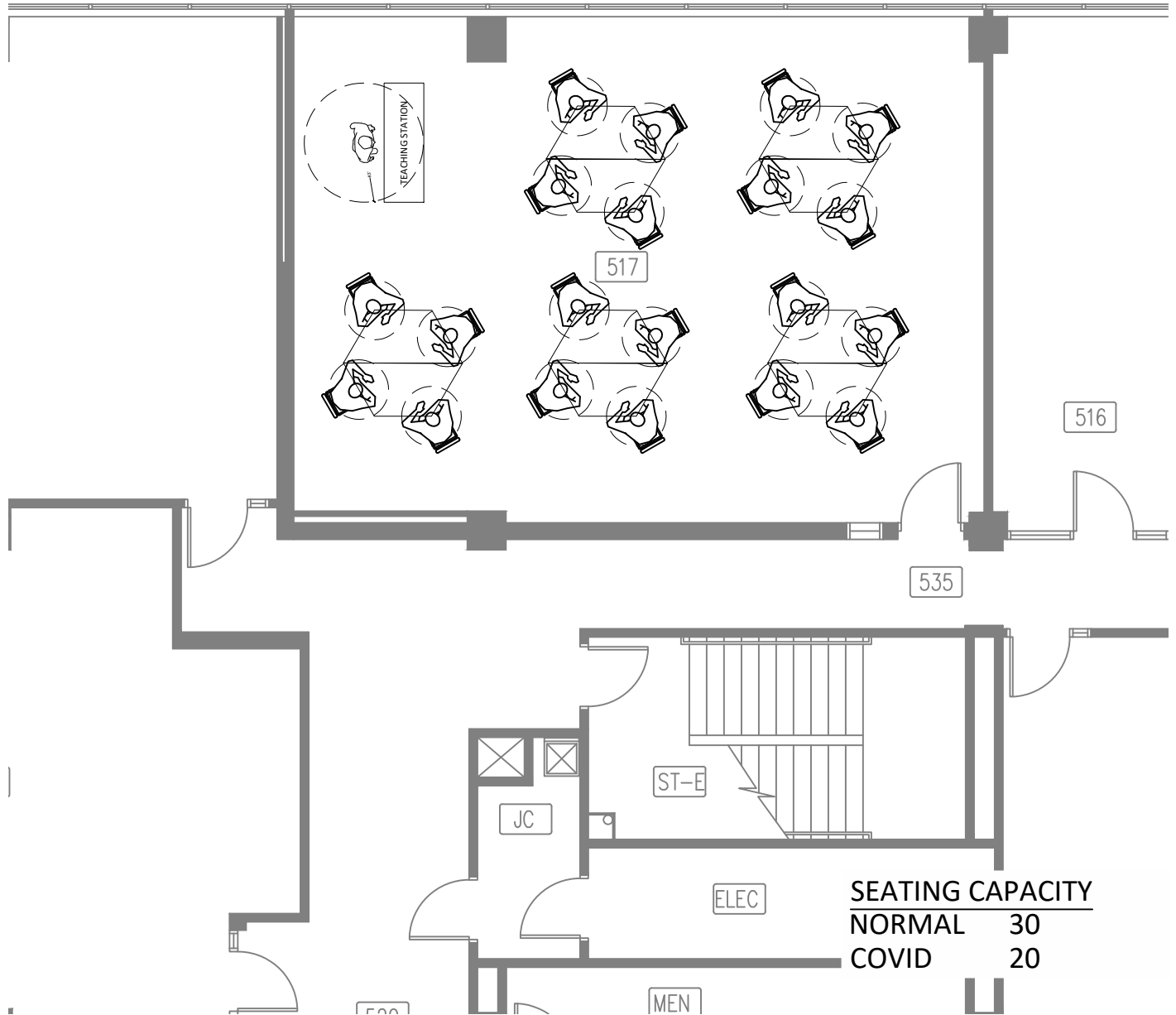
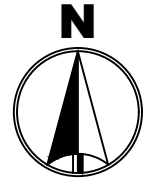

SEATING CAPACITY	
NORMAL	30
COVID	20

**MINNESOTA STATE UNIVERSITY**  
MANKATO  
**PLANNING & CONSTRUCTION**

**7700 FRANCE 517**  
COVID SEATING LAYOUT  
3' SOCIAL DISTANCE

DRAWN BY: N. HUETTL

March 2021

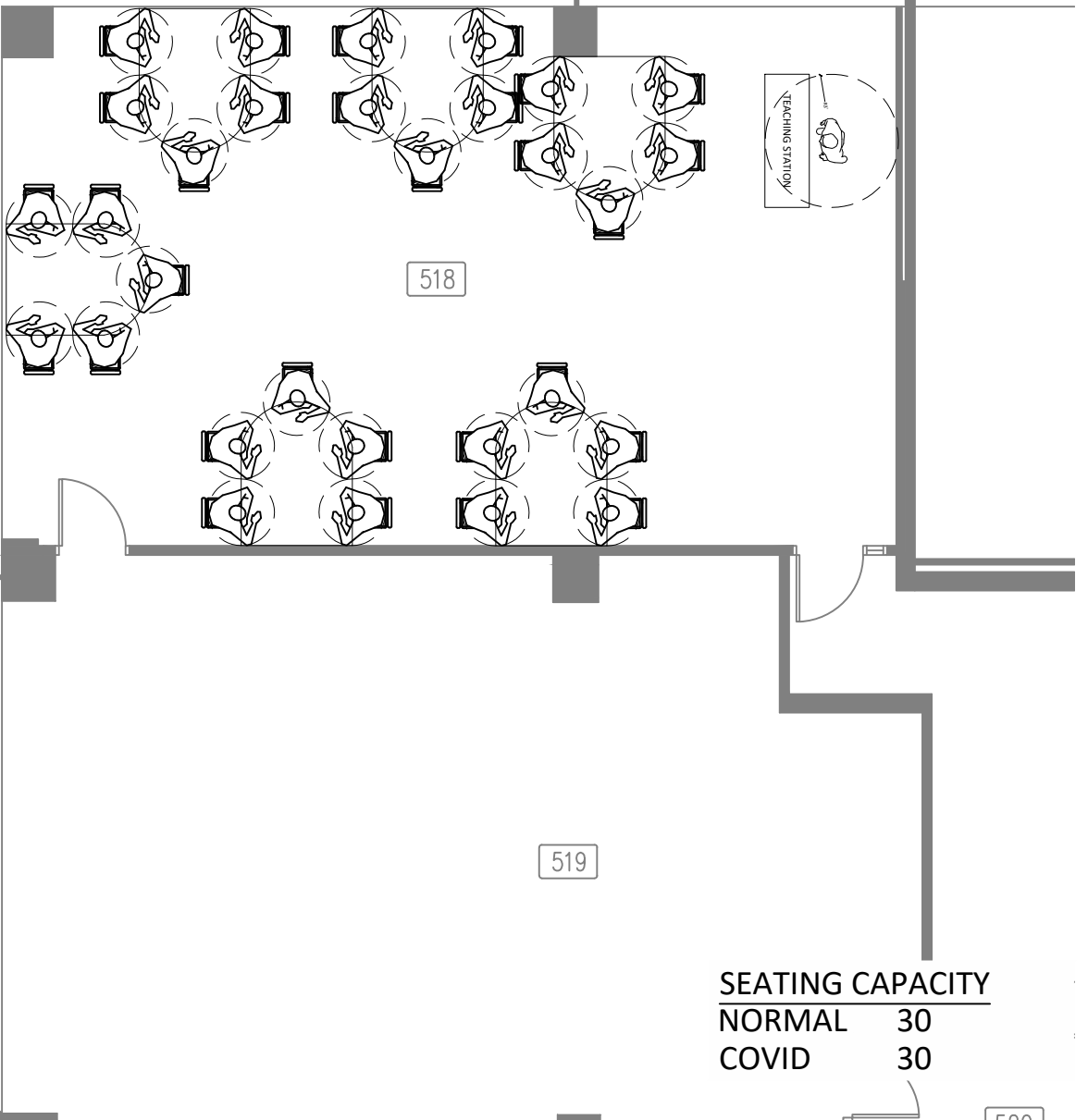
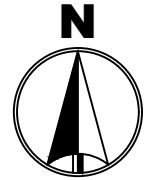

518

519

TEACHING STATION

SEATING CAPACITY  
NORMAL 30  
COVID 30

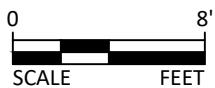

MINNESOTA STATE  
UNIVERSITY  
MANKATO  
PLANNING & CONSTRUCTION

7700 FRANCE 517  
COVID SEATING LAYOUT  
3' SOCIAL DISTANCE

DRAWN BY: N. HUETTL

March 2021



518

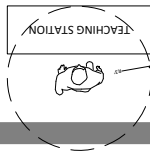
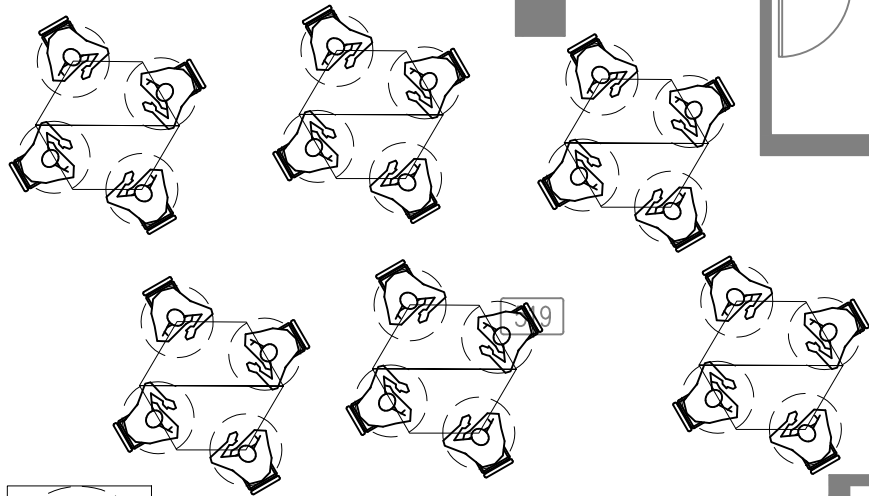

520

523

521

<b>SEATING CAPACITY</b>	
NORMAL	36
COVID	24



**MINNESOTA STATE UNIVERSITY**  
MANKATO  
**PLANNING & CONSTRUCTION**

**7700 FRANCE 519**  
COVID SEATING LAYOUT  
3' SOCIAL DISTANCE

DRAWN BY: N. HUETTL

March 2021

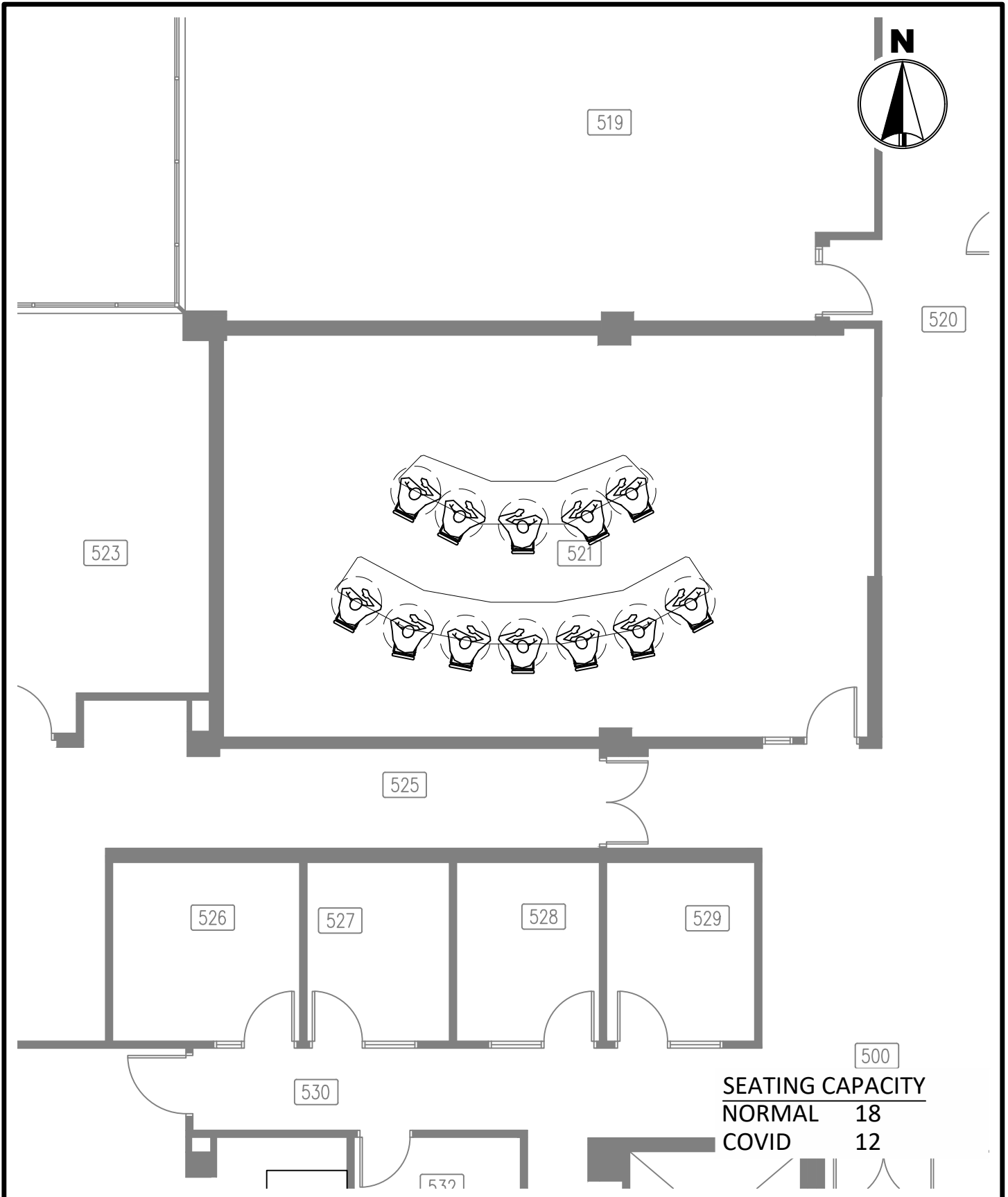

MINNESOTA STATE  
UNIVERSITY  
MANKATO  
PLANNING & CONSTRUCTION

7700 FRANCE 521  
COVID SEATING LAYOUT  
3' SOCIAL DISTANCE

DRAWN BY: N. HUETTL

March 2021

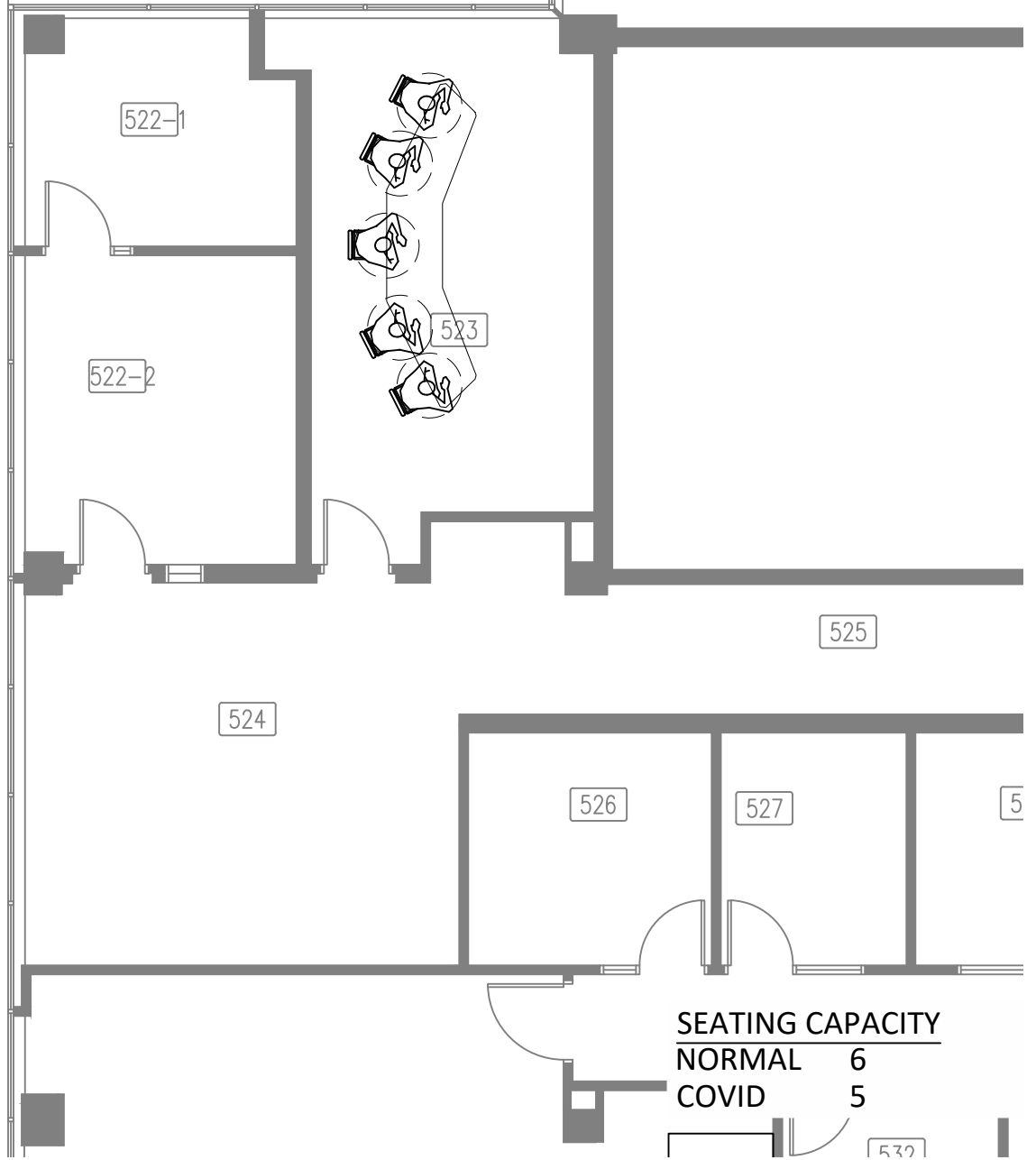
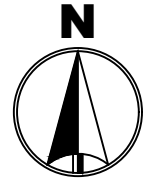

SEATING CAPACITY  
NORMAL 6  
COVID 5



MINNESOTA STATE  
UNIVERSITY  
MANKATO  
PLANNING & CONSTRUCTION

7700 FRANCE 523  
COVID SEATING LAYOUT  
3' SOCIAL DISTANCE

DRAWN BY: N. HUETTL

March 2021

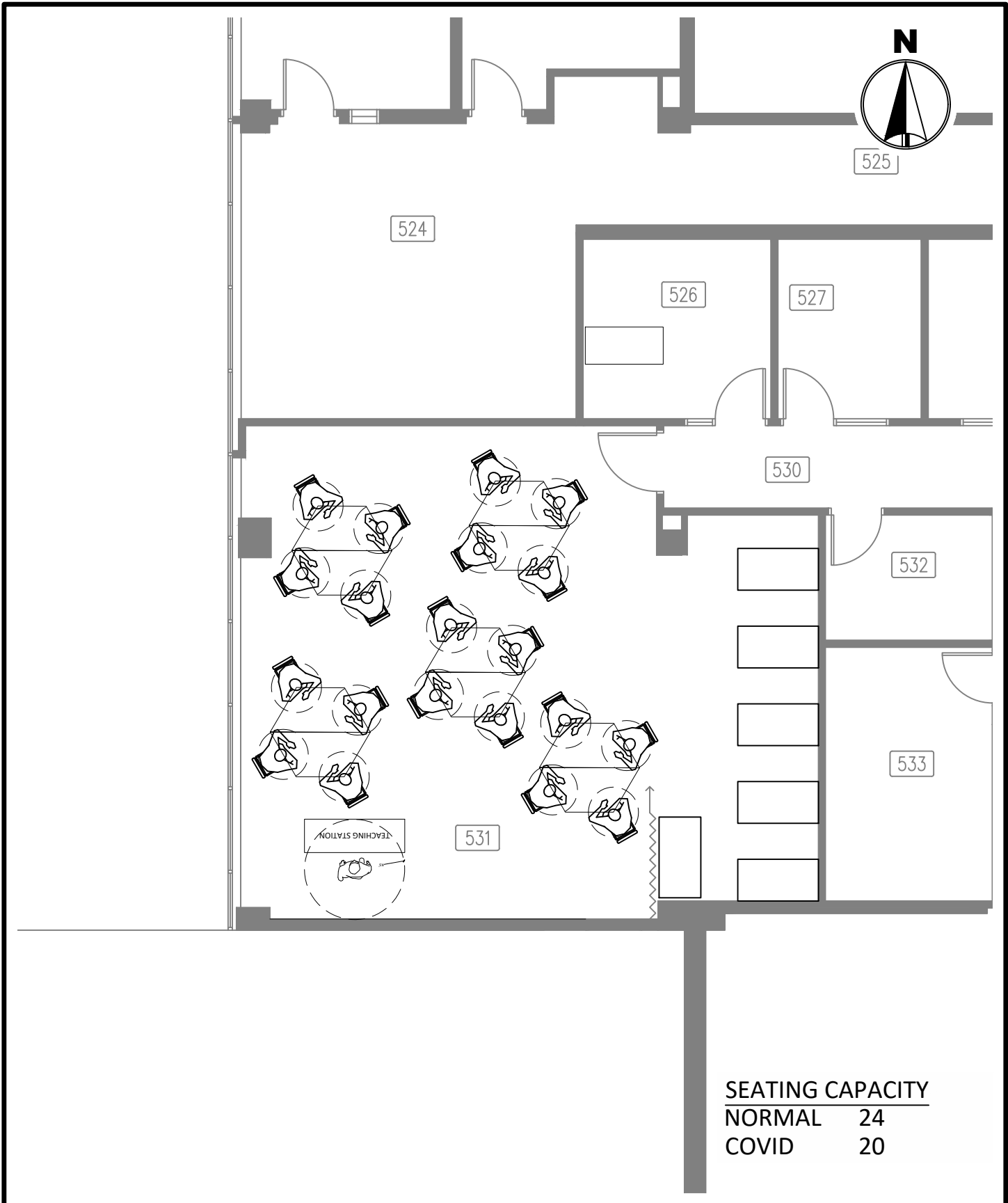

SEATING CAPACITY	
NORMAL	24
COVID	20

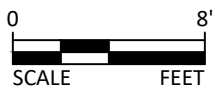

**MINNESOTA STATE UNIVERSITY**  
MANKATO  
**PLANNING & CONSTRUCTION**

**7700 FRANCE 531**  
COVID SEATING LAYOUT  
3' SOCIAL DISTANCE

DRAWN BY: N. HUETTL

March 2021

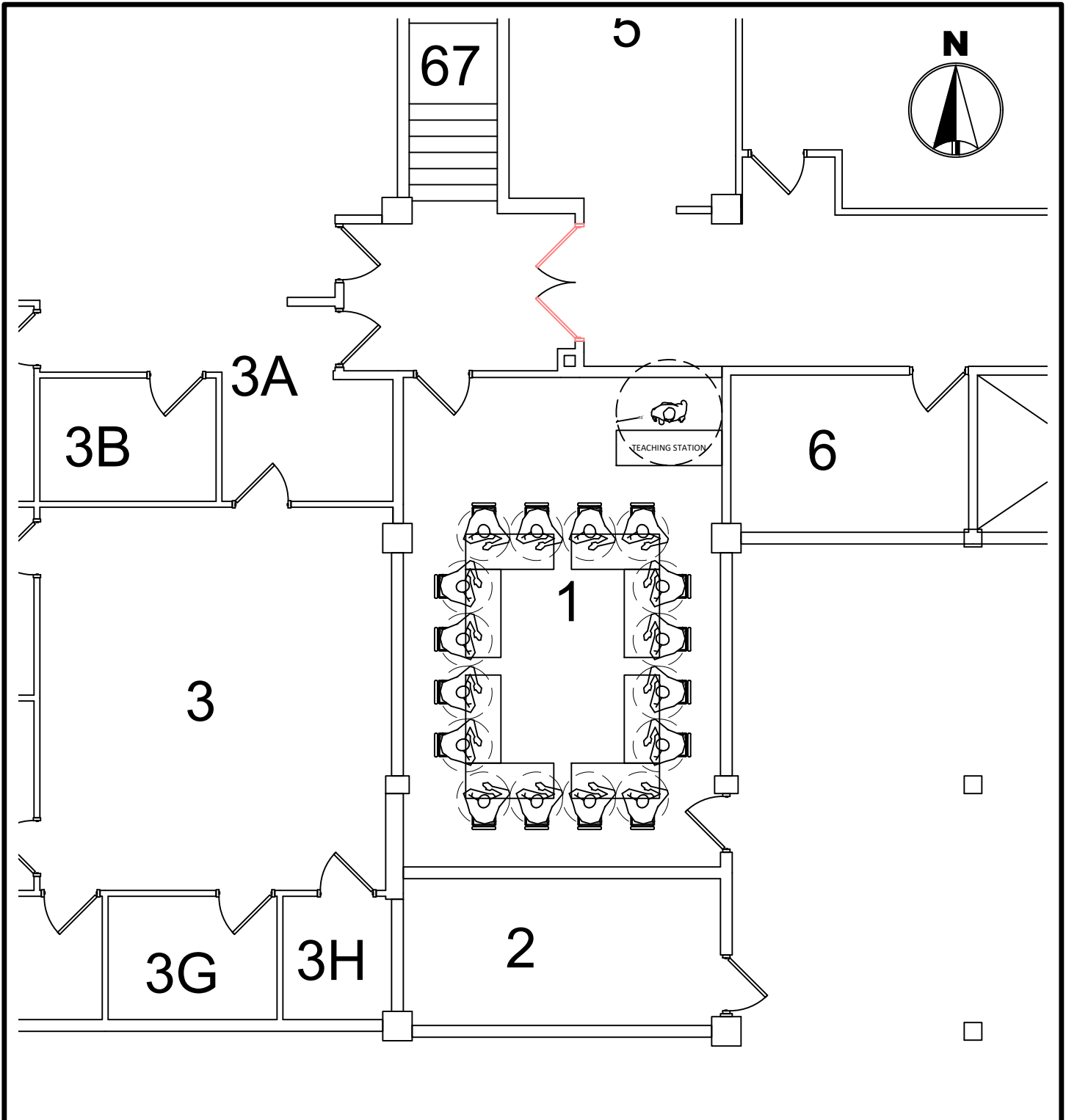

M2

SEATING CAPACITY	
NORMAL	18
COVID (3')	18



MINNESOTA STATE UNIVERSITY  
MANKATO  
PLANNING & CONSTRUCTION

ARMSTRONG HALL 001  
COVID SEATING LAYOUT  
3' SOCIAL DISTANCE

DRAWN BY: N. HUETTL

March 2021

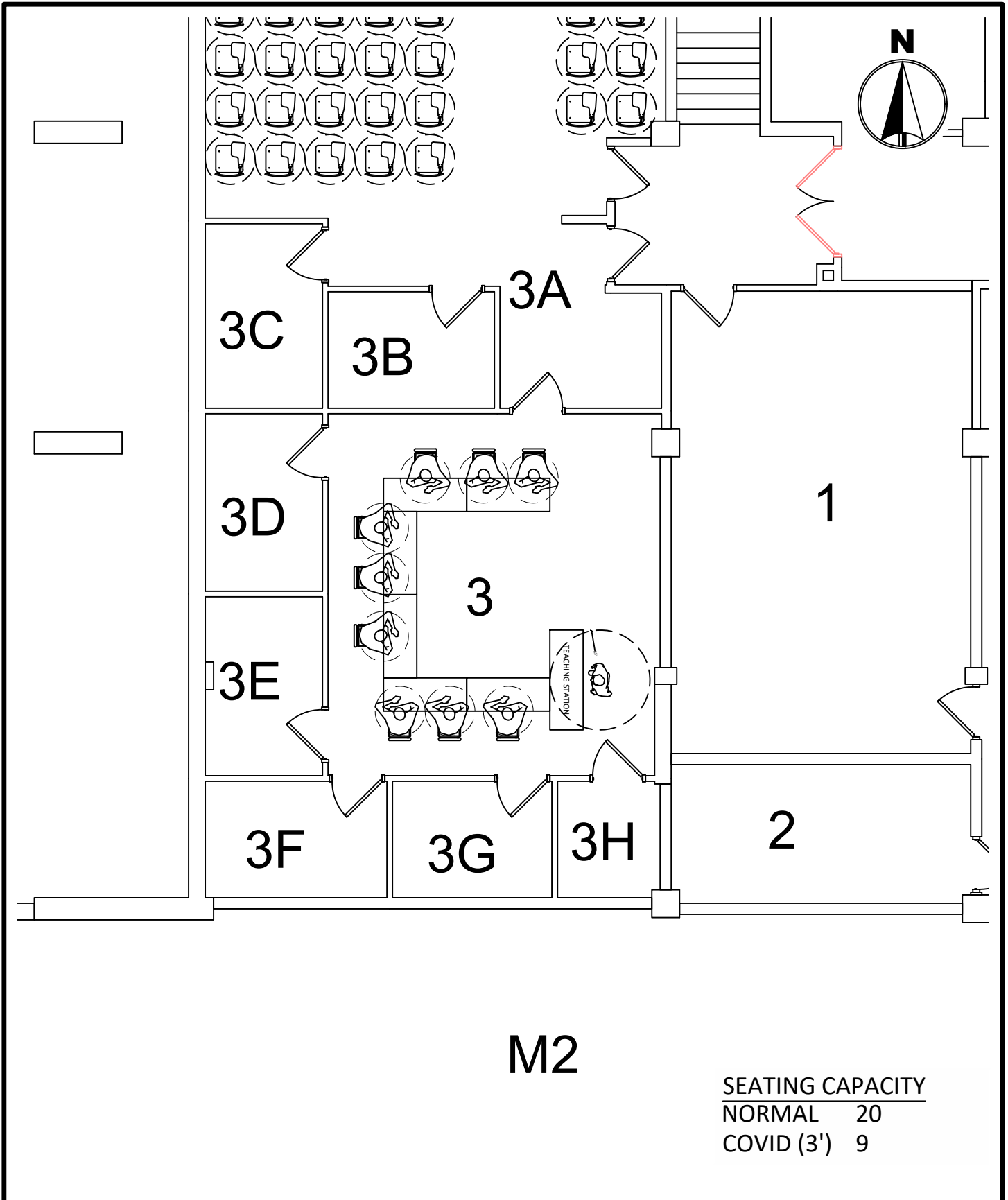

**MINNESOTA STATE UNIVERSITY**  
MANKATO  
PLANNING & CONSTRUCTION

**ARMSTRONG HALL 003**  
COVID (3') SEATING LAYOUT  
3' SOCIAL DISTANCE

DRAWN BY: N. HUETTL

March 2021



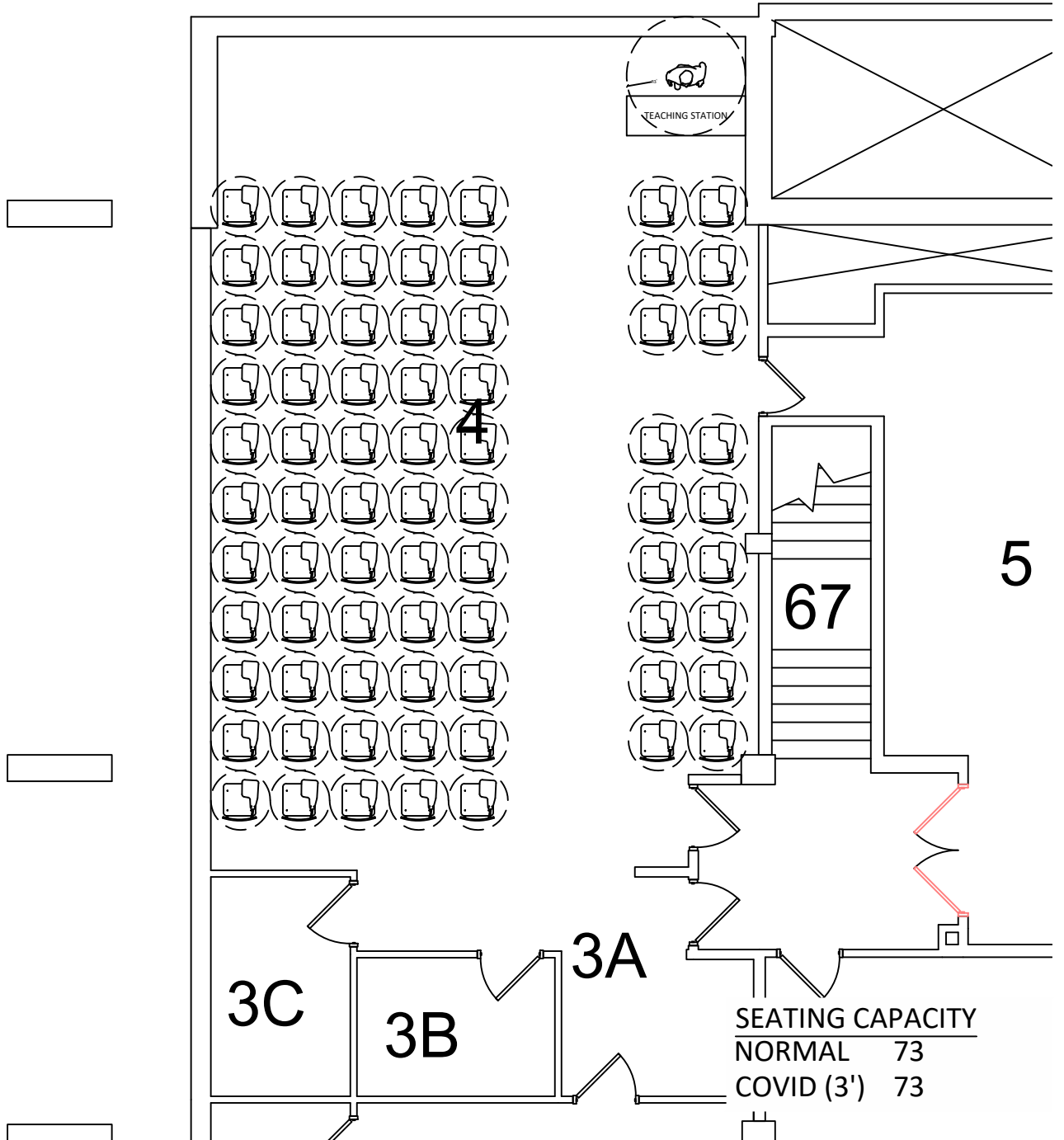
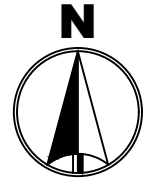

MINNESOTA STATE  
UNIVERSITY  
MANKATO  
PLANNING & CONSTRUCTION

ARMSTRONG HALL 004  
COVID SEATING LAYOUT  
3' SOCIAL DISTANCE

DRAWN BY: N. HUETTL

March 2021

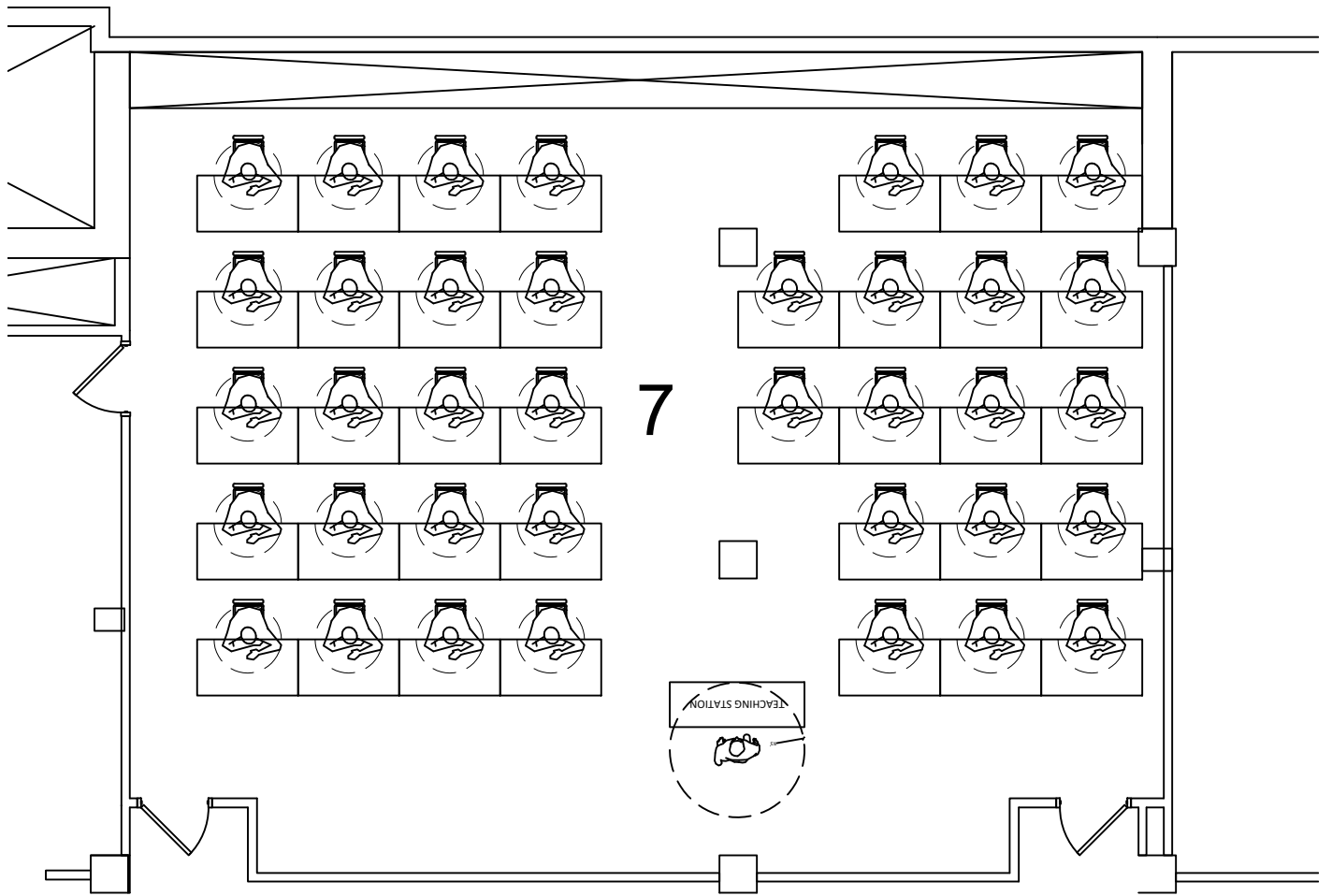
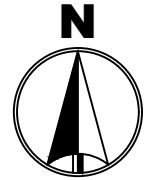

62

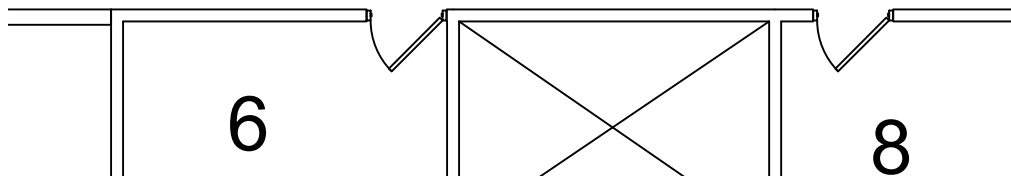

SEATING CAPACITY	
NORMAL	65
COVID (3')	37



MINNESOTA STATE  
UNIVERSITY  
MANKATO  
PLANNING & CONSTRUCTION

ARMSTRONG HALL 007  
COVID SEATING LAYOUT  
3' SOCIAL DISTANCE

DRAWN BY: N. HUETTL

March 2021

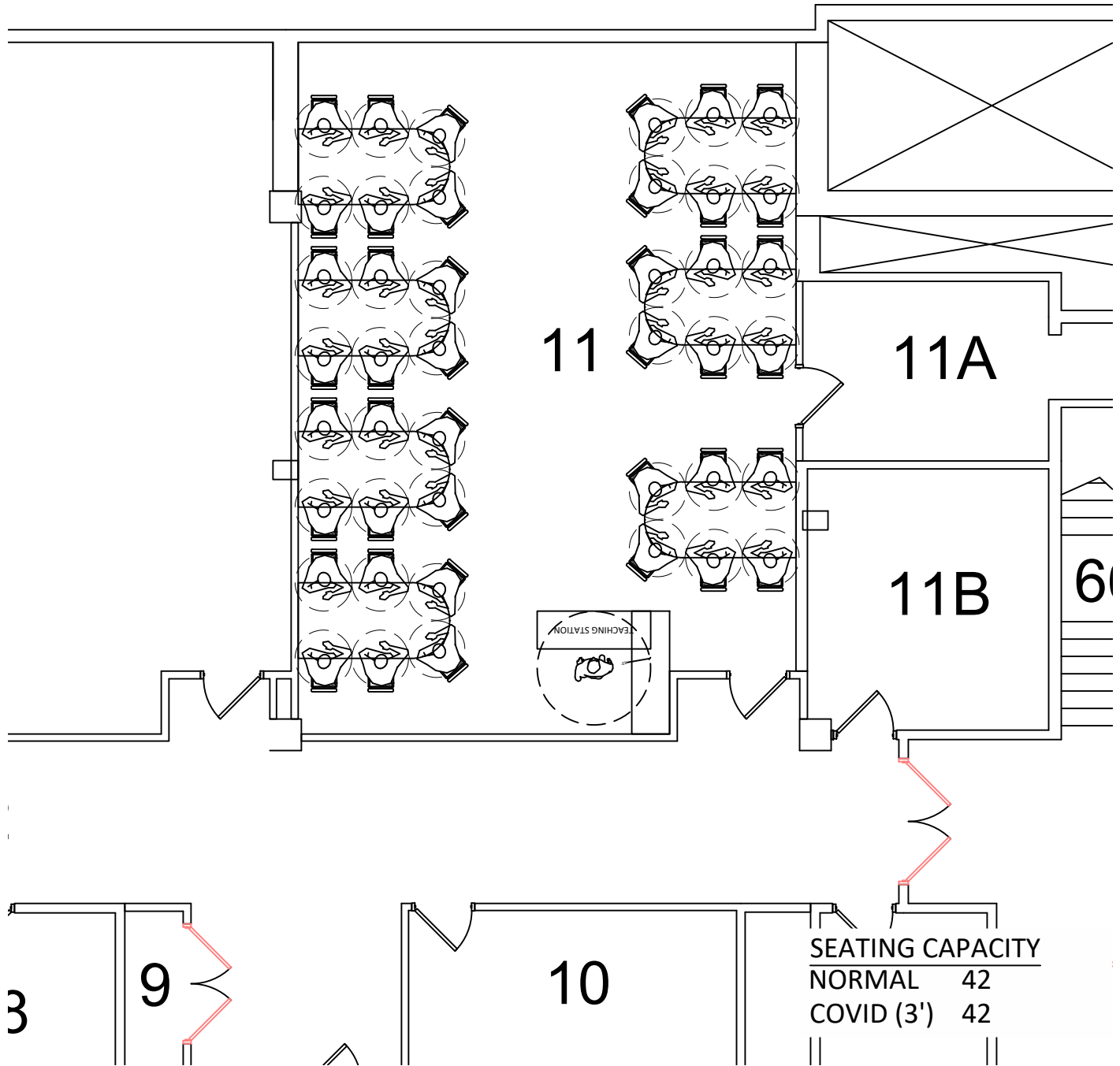
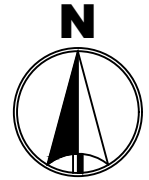

MINNESOTA STATE  
UNIVERSITY  
MANKATO  
PLANNING & CONSTRUCTION

ARMSTRONG HALL 011  
COVID SEATING LAYOUT  
3' SOCIAL DISTANCE

DRAWN BY: N. HUETTL

March 2021

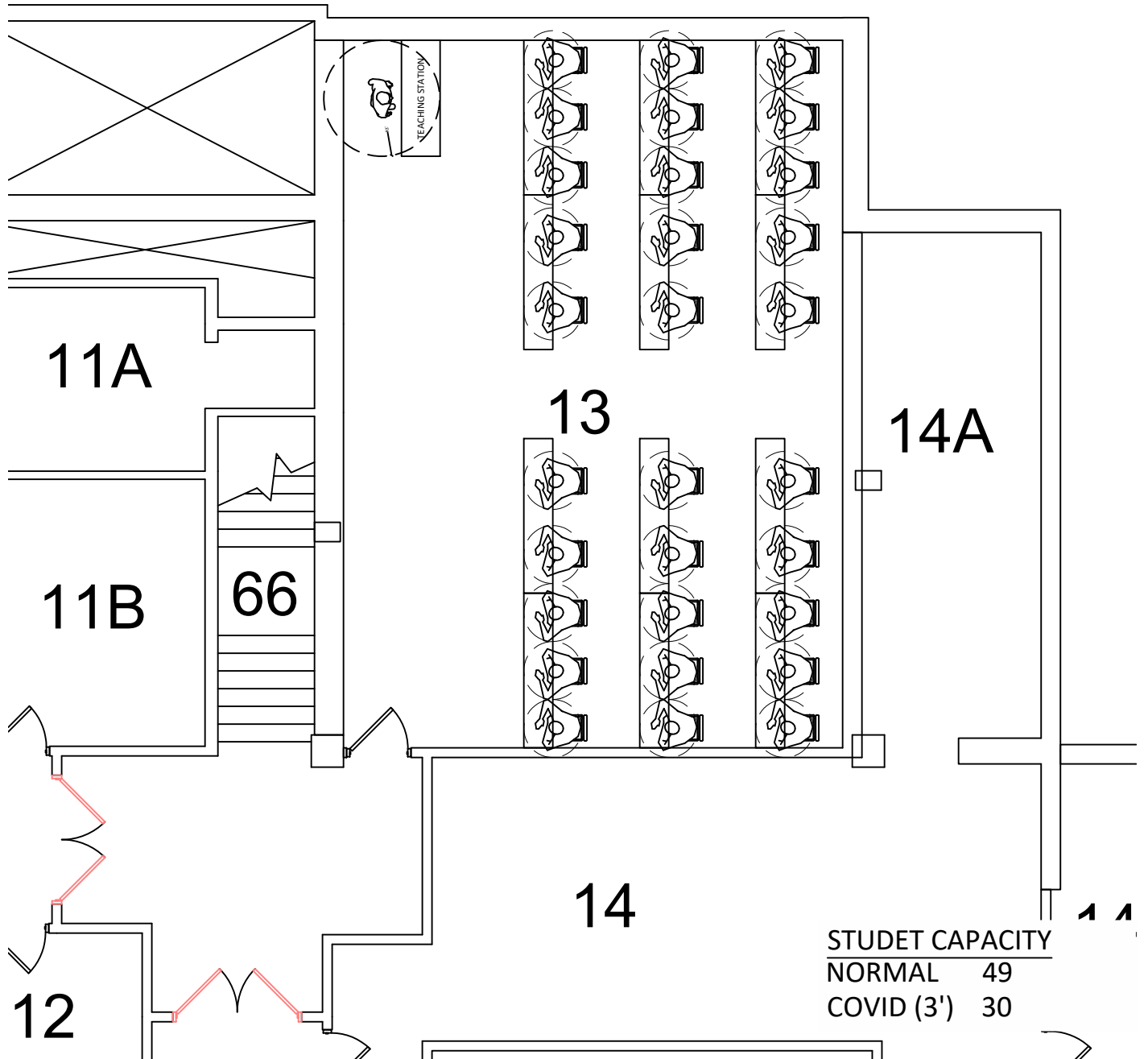

MINNESOTA STATE  
UNIVERSITY  
MANKATO  
PLANNING & CONSTRUCTION

ARMSTRONG HALL 013  
COVID SEATING LAYOUT  
3' SOCIAL DISTANCE

DRAWN BY: N. HUETTL

March 2021

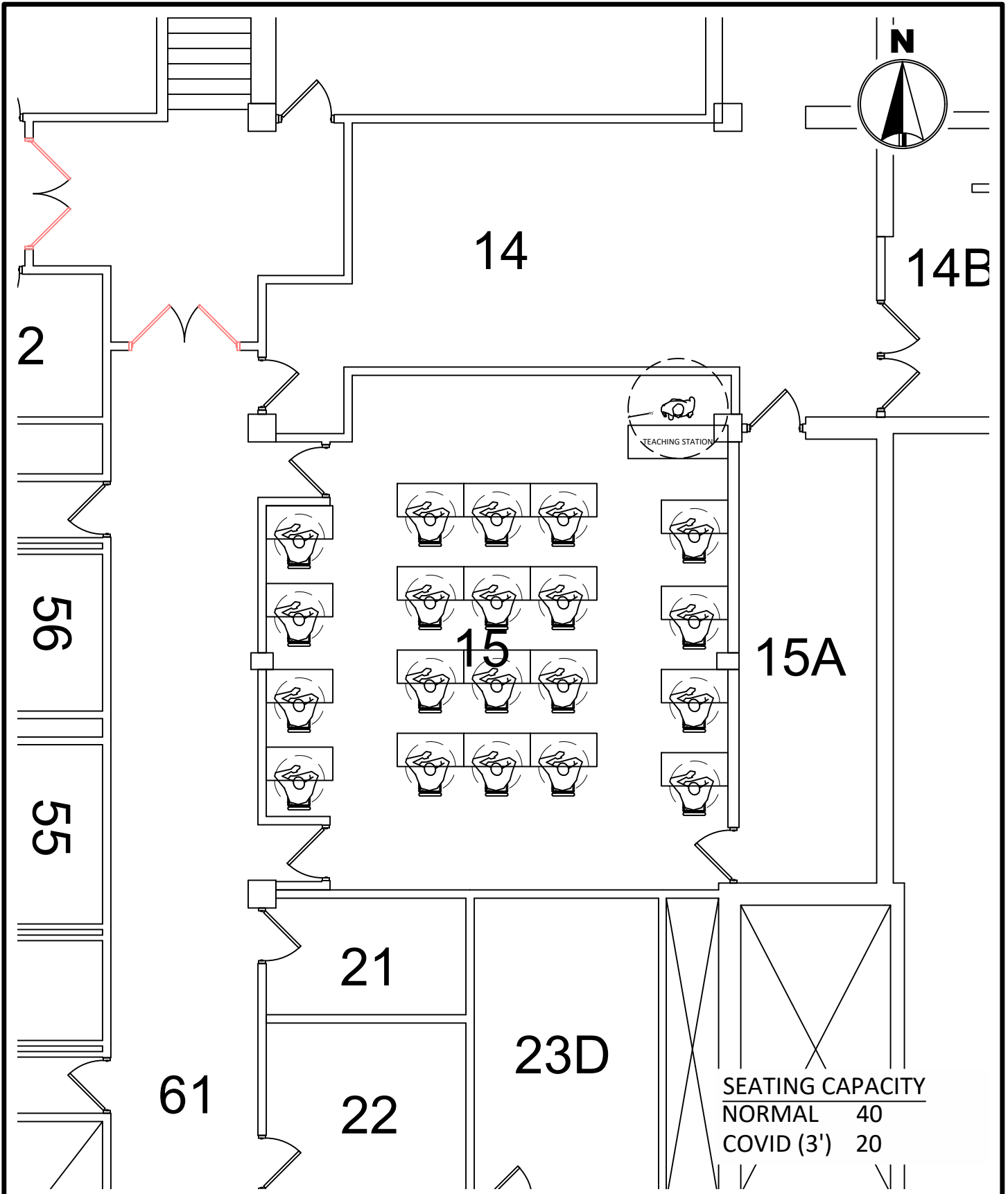

MINNESOTA STATE  
UNIVERSITY  
MANKATO  
PLANNING & CONSTRUCTION

ARMSTRONG HALL 015  
COVID SEATING LAYOUT  
3' SOCIAL DISTANCE

DRAWN BY: N. HUETTL

March 2021

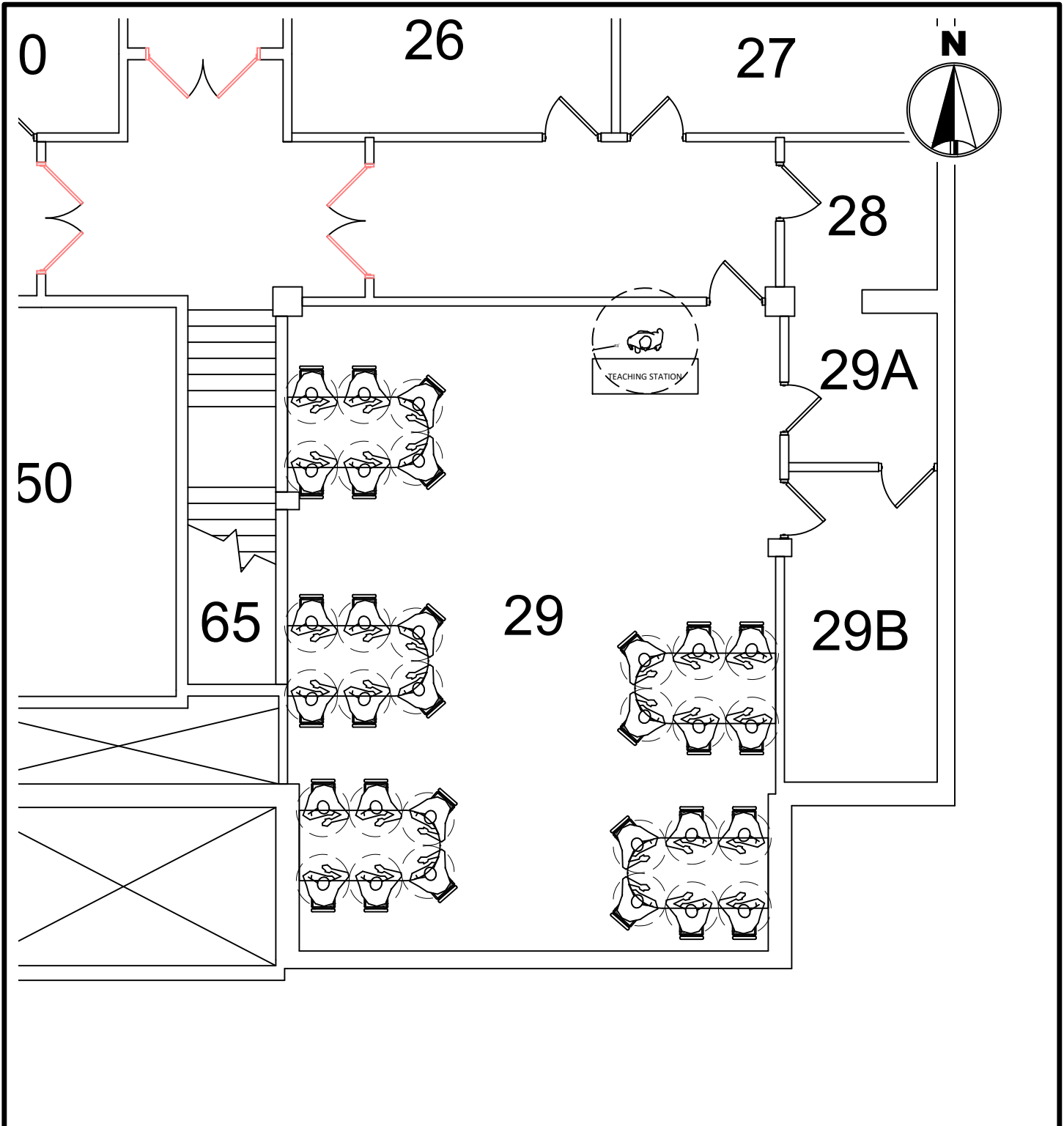

SEATING CAPACITY	
NORMAL	37
COVID (3')	30



**MINNESOTA STATE UNIVERSITY**  
MANKATO  
**PLANNING & CONSTRUCTION**

**ARMSTRONG HALL 029**  
COVID SEATING LAYOUT  
3' SOCIAL DISTANCE

DRAWN BY: N. HUETTL

March 2021

M2

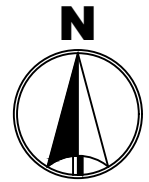

39B

38A

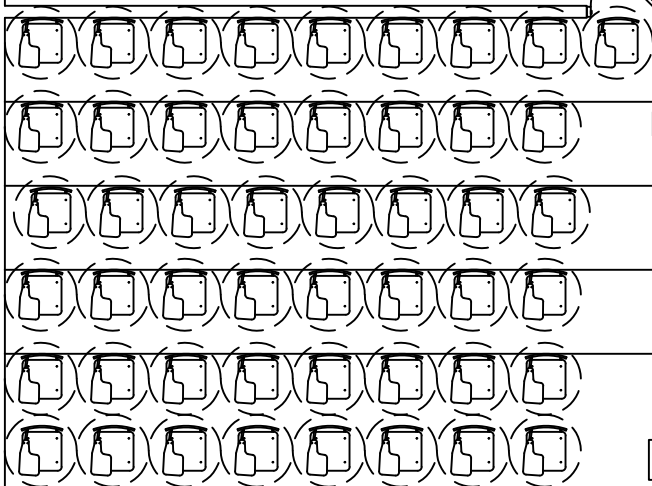

38

39

39A



39C

SEATING CAPACITY	
NORMAL	49
COVID (3')	49



**MINNESOTA STATE UNIVERSITY**  
MANKATO  
PLANNING & CONSTRUCTION

**ARMSTRONG HALL 039**  
COVID SEATING LAYOUT  
3' SOCIAL DISTANCE

DRAWN BY: N. HUETTL

March 2021

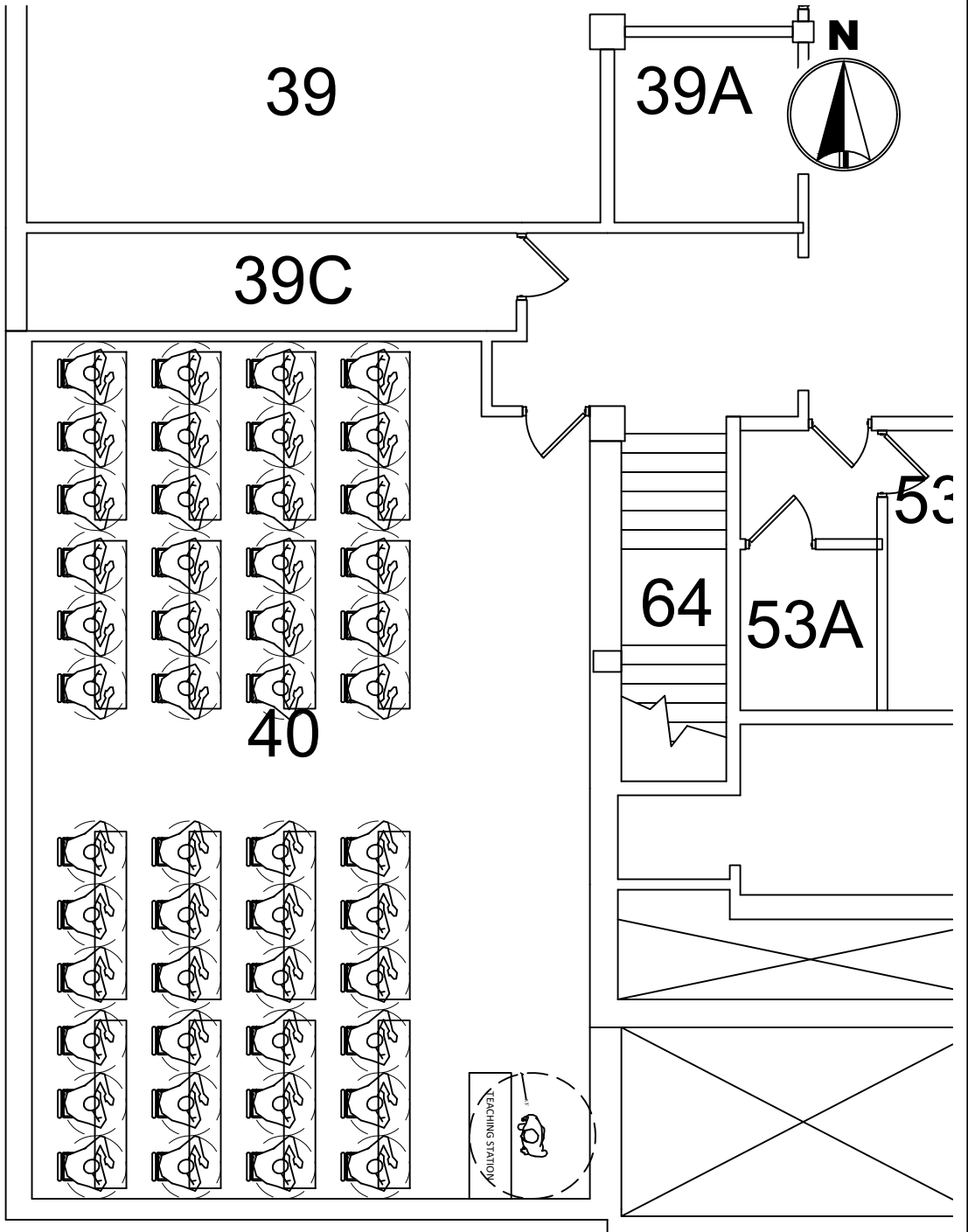

SEATING CAPACITY	
NORMAL	48
COVID (3')	48

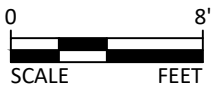

**MINNESOTA STATE UNIVERSITY**  
MANKATO  
**PLANNING & CONSTRUCTION**

**ARMSTRONG HALL 040**  
COVID SEATING LAYOUT  
3' SOCIAL DISTANCE

DRAWN BY: N. HUETTL

March 2021



100

102A

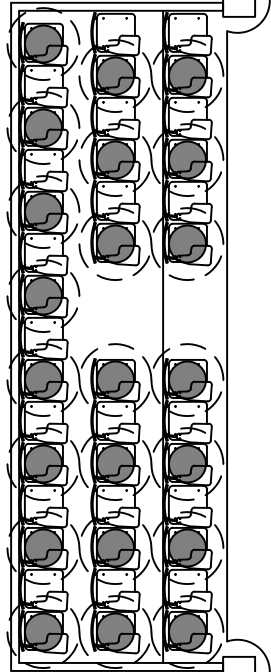
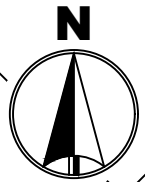

101

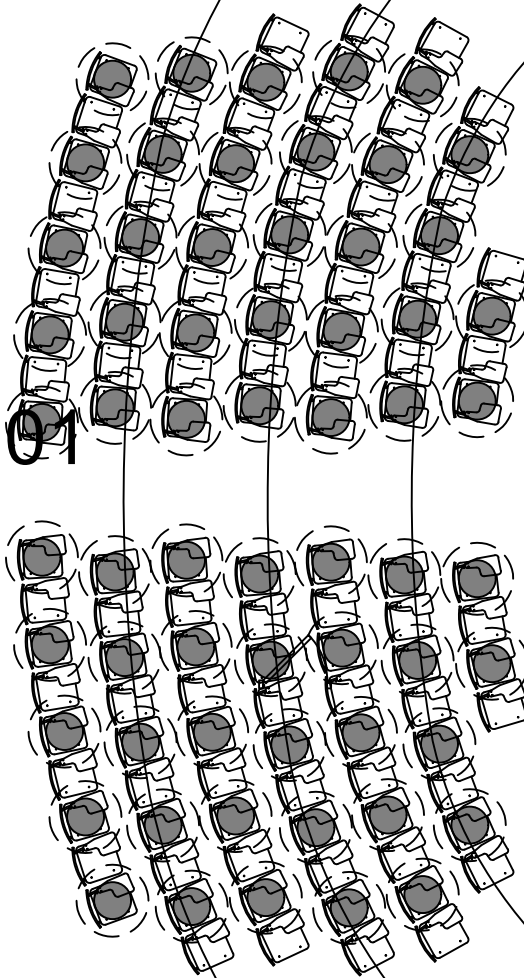

101A

SEATING CAPACITY	
NORMAL	161
COVID (3')	84
118H	



MINNESOTA STATE UNIVERSITY  
MANKATO

PLANNING & CONSTRUCTION

ARMSTRONG HALL 101  
COVID SEATING LAYOUT  
3' SOCIAL DISTANCE

DRAWN BY: N. HUETTL

March 2021

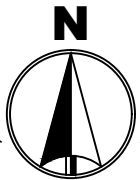

113F  
OFFICE

113G  
OFFICE

113H  
OFFICE

113I  
OFFICE

MEN

125

124

102

102A

100

SEATING CAPACITY	
NORMAL	112
COVID (3')	56



MINNESOTA STATE  
UNIVERSITY  
MANKATO  
PLANNING & CONSTRUCTION

ARMSTRONG HALL 102  
COVID SEATING LAYOUT  
3' SOCIAL DISTANCE

DRAWN BY: N. HUETTL

March 2021

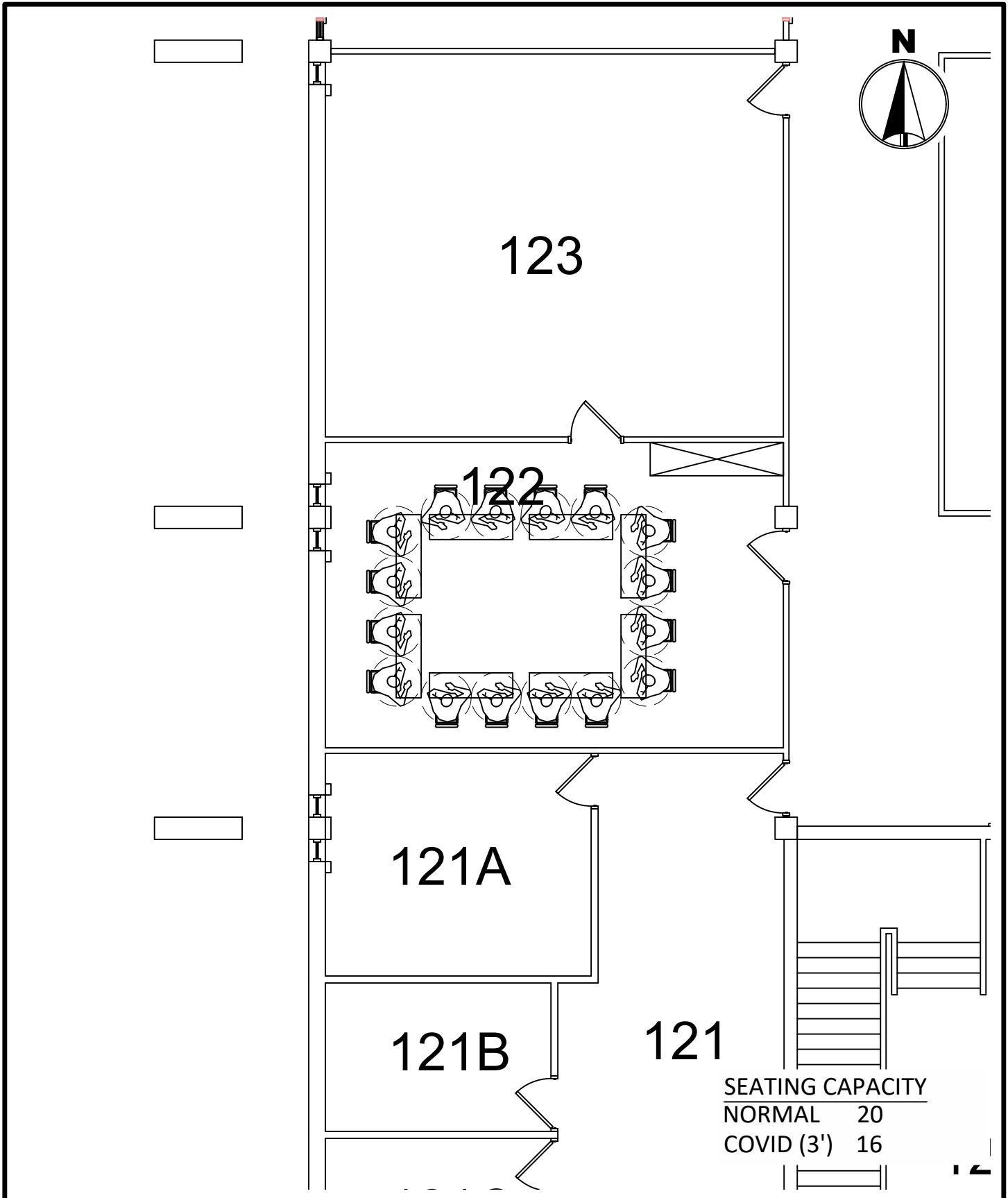

SEATING CAPACITY	
NORMAL	20
COVID (3')	16



**MINNESOTA STATE UNIVERSITY**  
MANKATO  
PLANNING & CONSTRUCTION

**ARMSTRONG HALL 122**  
COVID SEATING LAYOUT  
3' SOCIAL DISTANCE

DRAWN BY: N. HUETTL March 2021

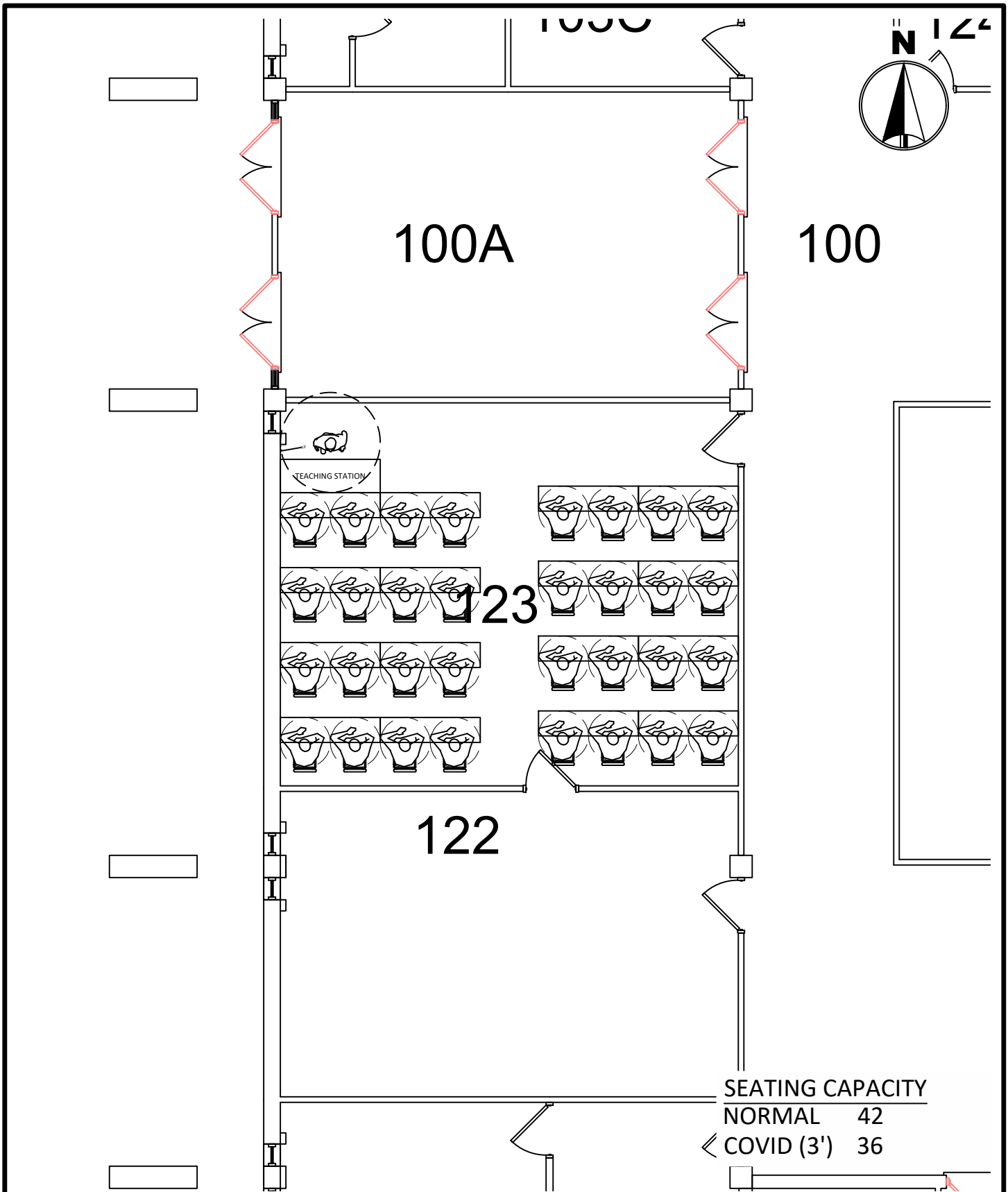

MINNESOTA STATE UNIVERSITY  
MANKATO  
PLANNING & CONSTRUCTION

ARMSTRONG HALL 123  
COVID SEATING LAYOUT  
3' SOCIAL DISTANCE

DRAWN BY: N. HUETTL

March 2021

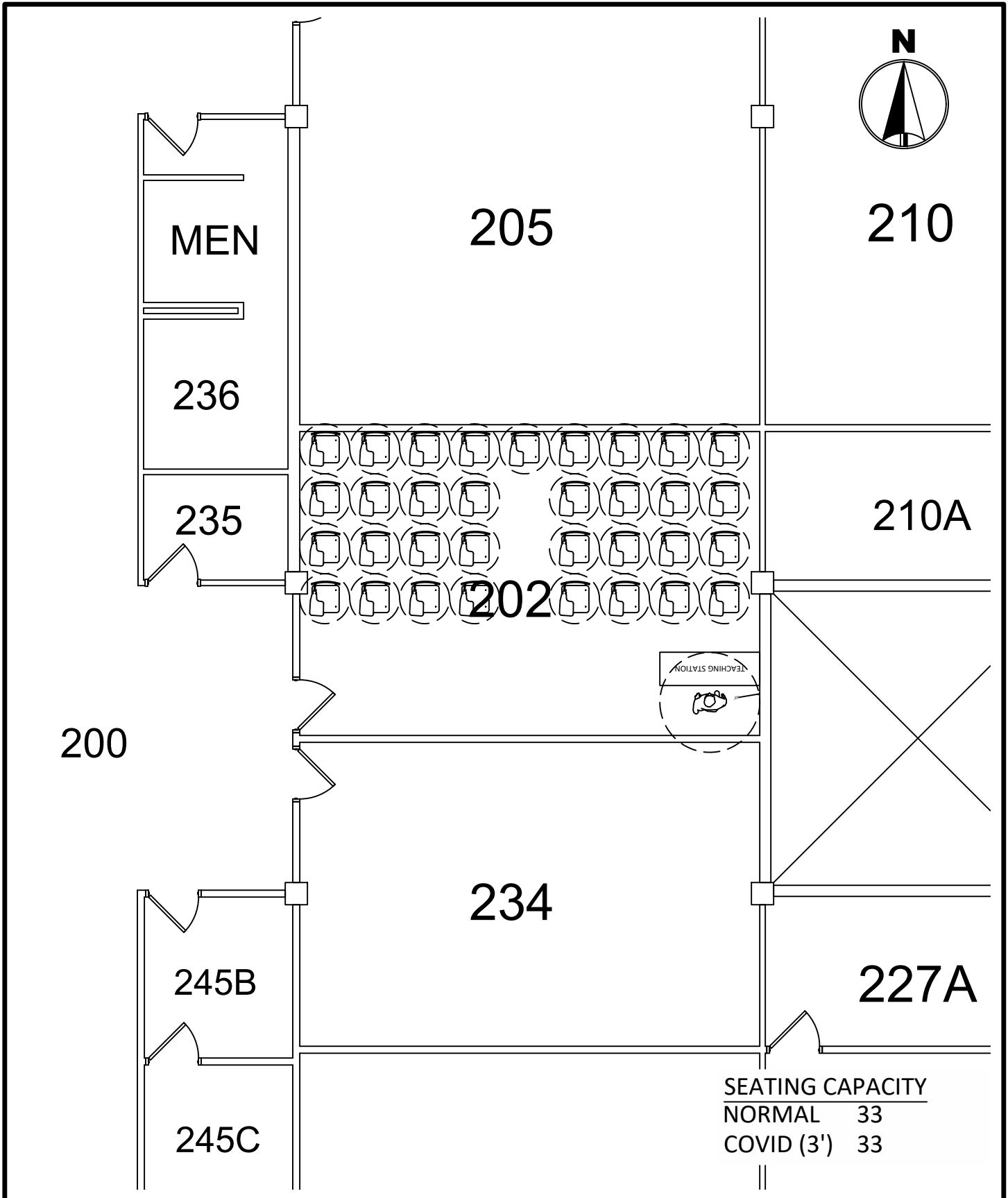

MINNESOTA STATE  
UNIVERSITY  
MANKATO  
PLANNING & CONSTRUCTION

ARMSTRONG HALL 202  
COVID SEATING LAYOUT  
3' SOCIAL DISTANCE

DRAWN BY: N. HUETTL

March 2021

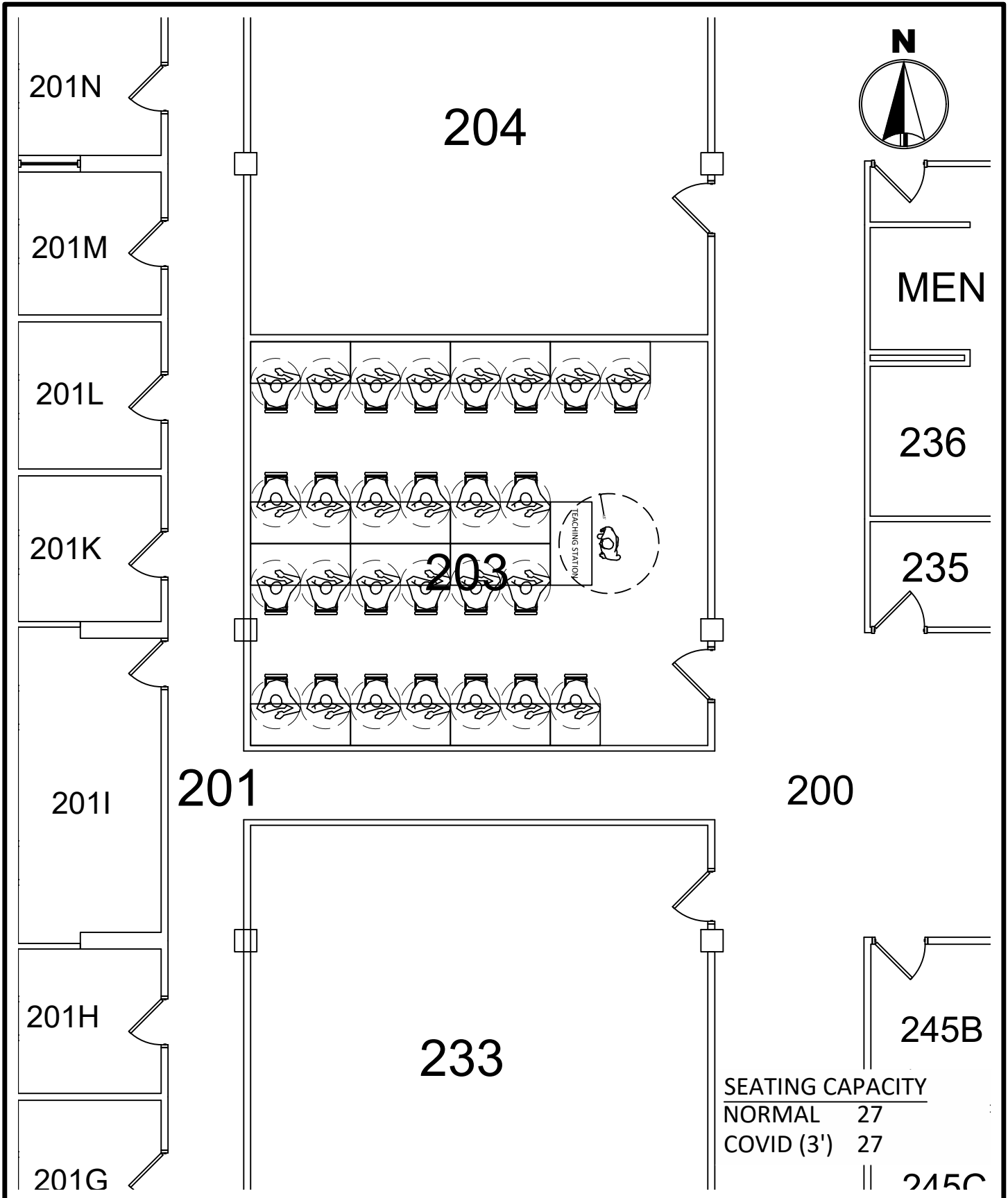

SEATING CAPACITY	
NORMAL	27
COVID (3')	27

245C



**MINNESOTA STATE UNIVERSITY**  
MANKATO  
PLANNING & CONSTRUCTION

**ARMSTRONG HALL 203**  
COVID SEATING LAYOUT  
3' SOCIAL DISTANCE

DRAWN BY: N. HUETTL March 2021

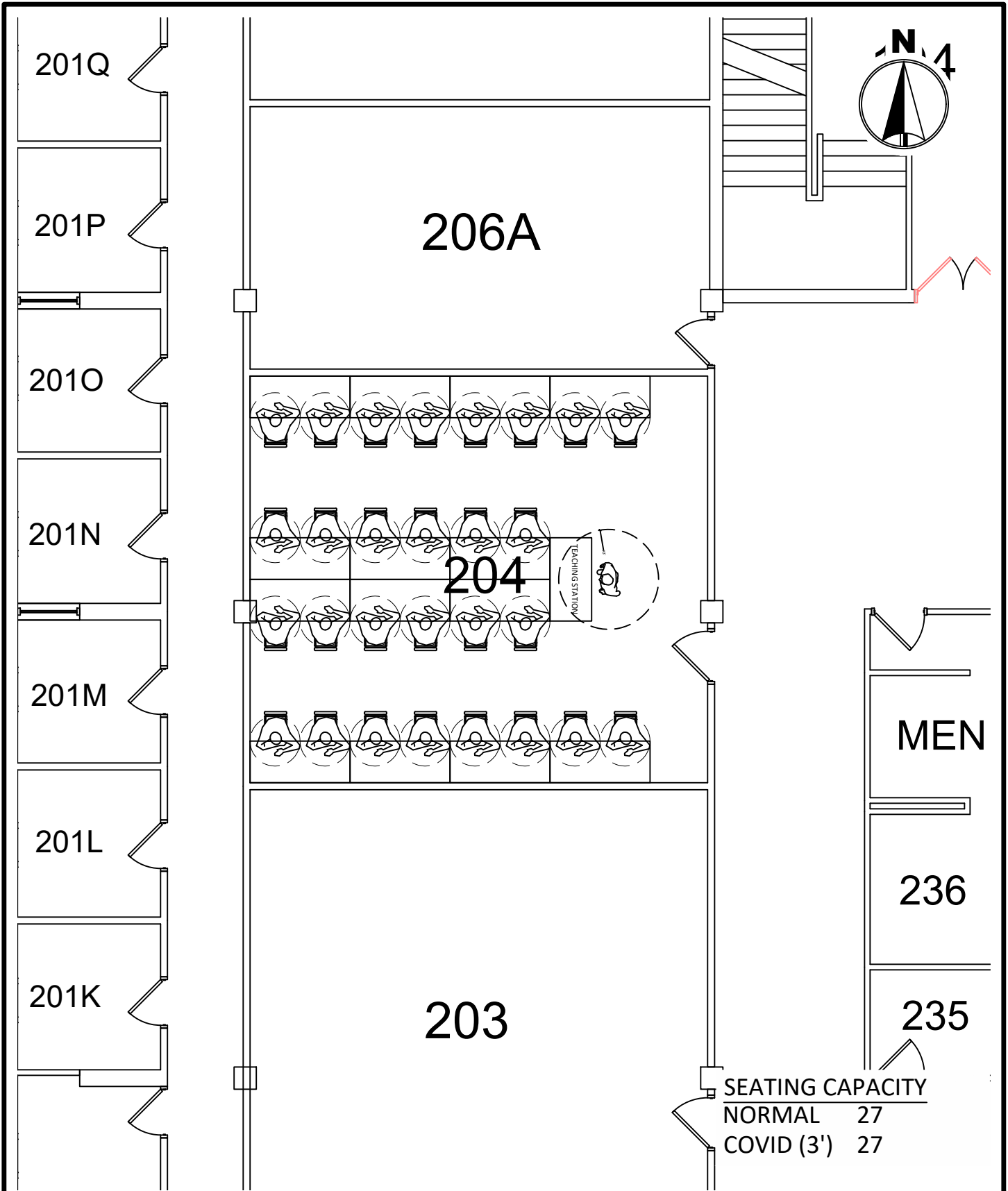

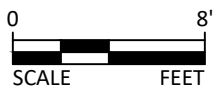
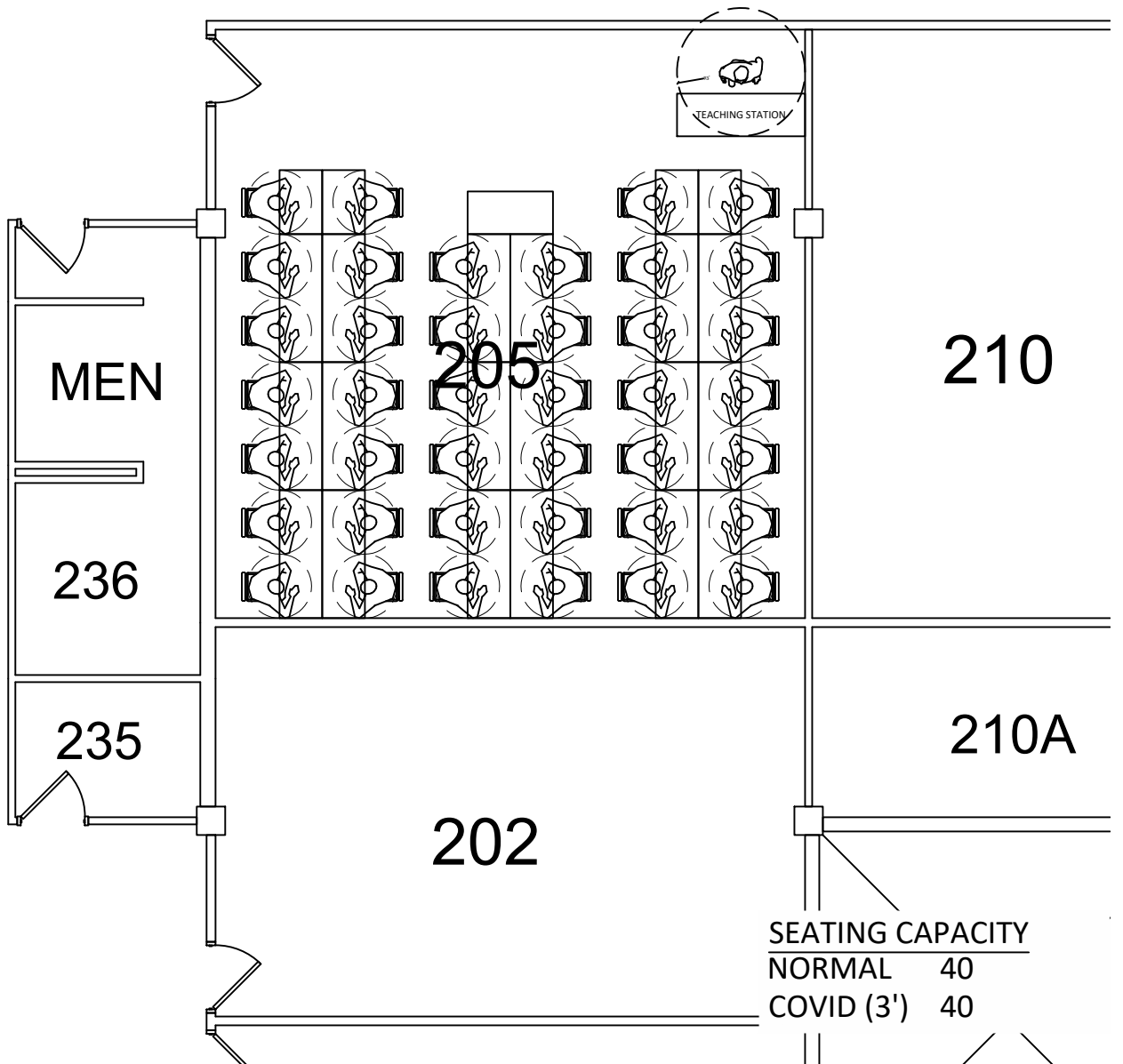
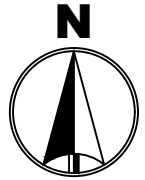

MINNESOTA STATE  
UNIVERSITY  
MANKATO  
PLANNING & CONSTRUCTION

ARMSTRONG HALL 205  
COVID SEATING LAYOUT  
3' SOCIAL DISTANCE

DRAWN BY: N. HUETTL

March 2021



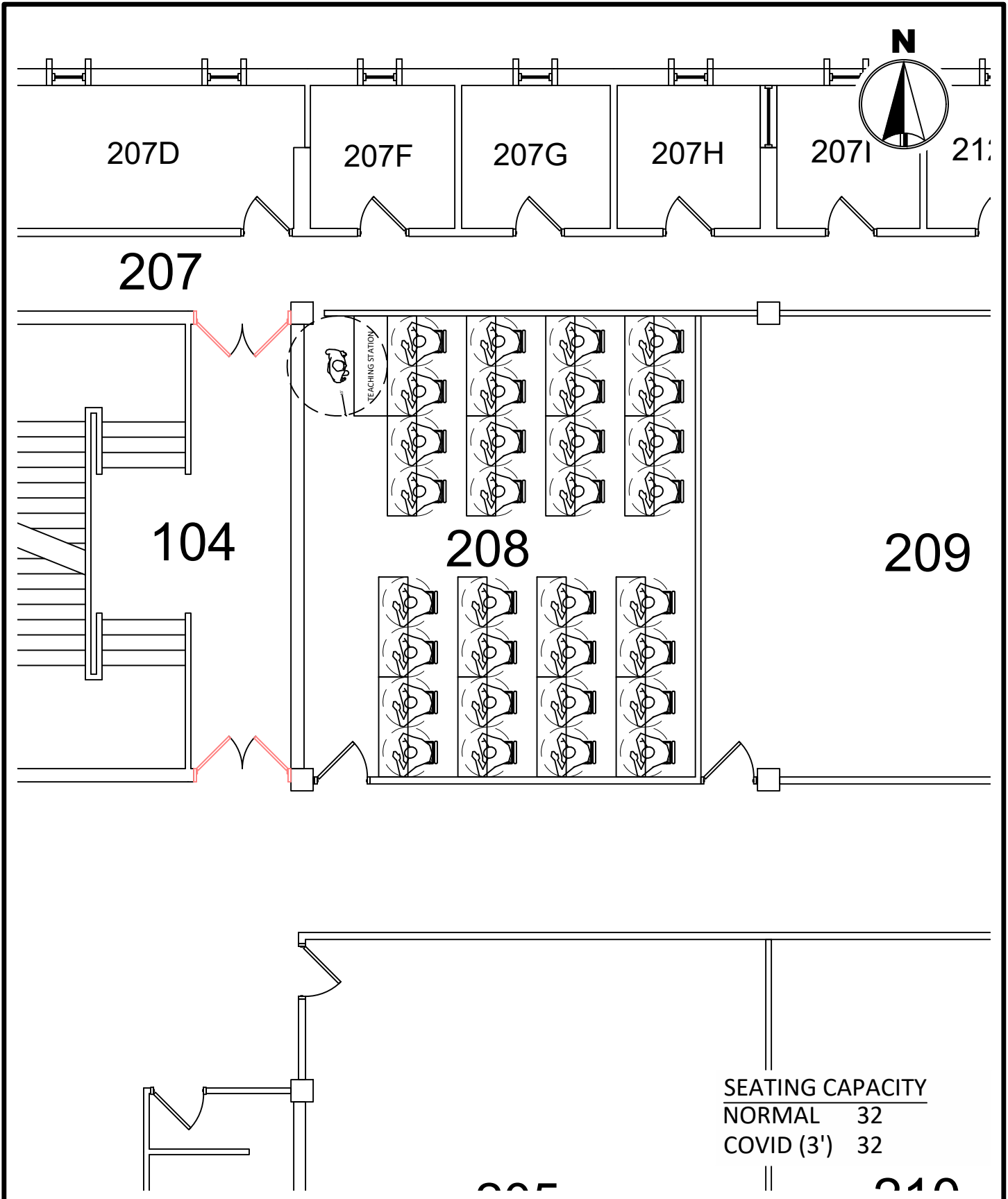

MINNESOTA STATE  
UNIVERSITY  
MANKATO  
PLANNING & CONSTRUCTION

ARMSTRONG HALL 208  
COVID SEATING LAYOUT  
3' SOCIAL DISTANCE

DRAWN BY: N. HUETTL

March 2021

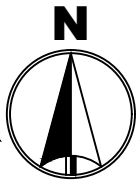

207G

207H

207I

212A

212B

212C

208

209

211

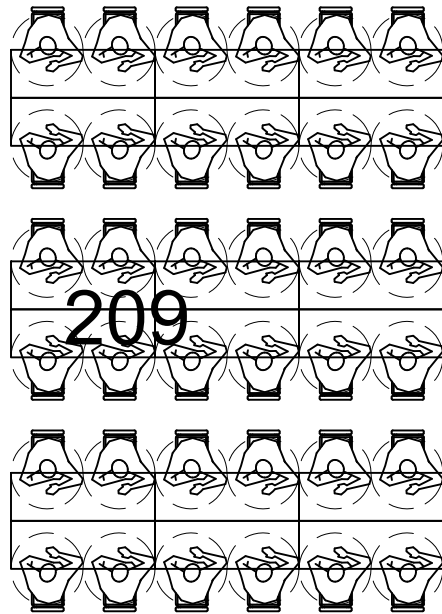
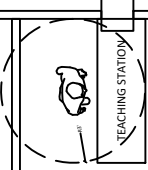

SEATING CAPACITY	
NORMAL	36
COVID (3')	36



**MINNESOTA STATE UNIVERSITY**  
MANKATO  
**PLANNING & CONSTRUCTION**

**ARMSTRONG HALL 209**  
COVID SEATING LAYOUT  
3' SOCIAL DISTANCE

DRAWN BY: N. HUETTL

March 2021

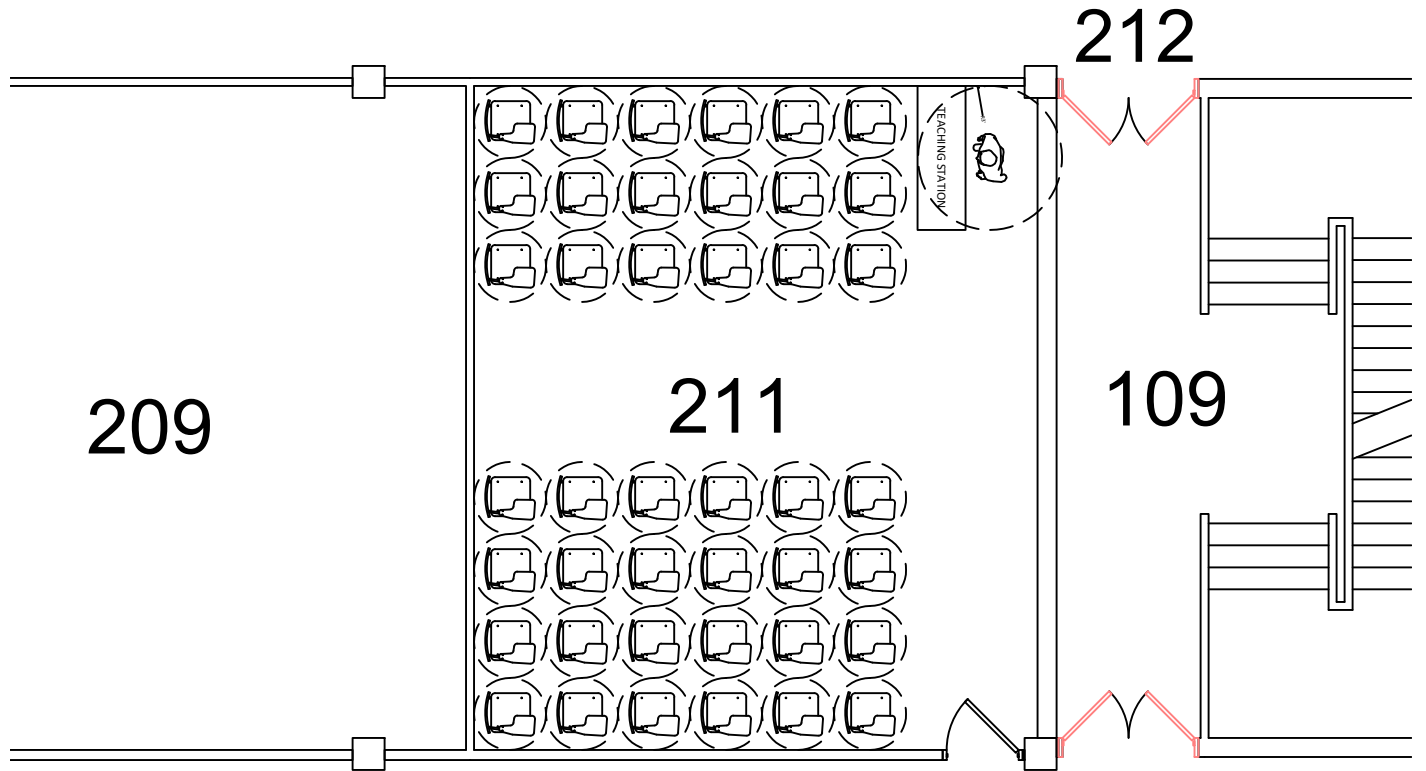
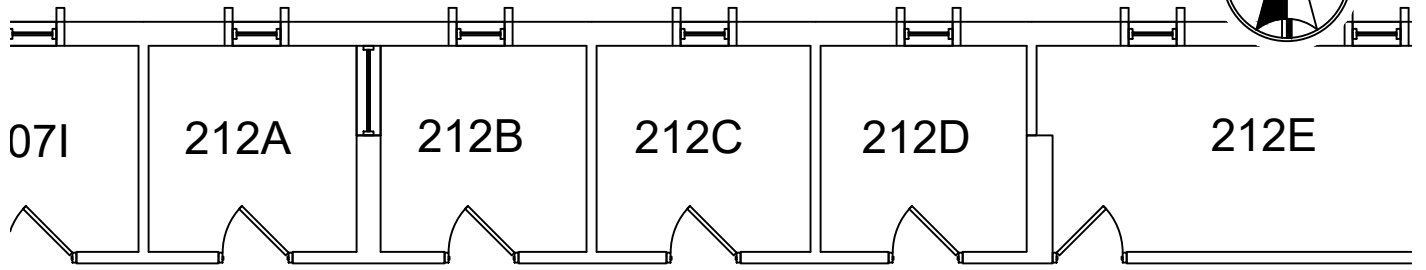
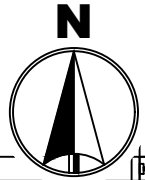

SEATING CAPACITY	
NORMAL	42
COVID (3')	42
TT / / / / / /	



**MINNESOTA STATE UNIVERSITY**  
MANKATO  
**PLANNING & CONSTRUCTION**

**ARMSTRONG HALL 211**  
COVID SEATING LAYOUT  
3' SOCIAL DISTANCE

DRAWN BY: N. HUETTL

March 2021

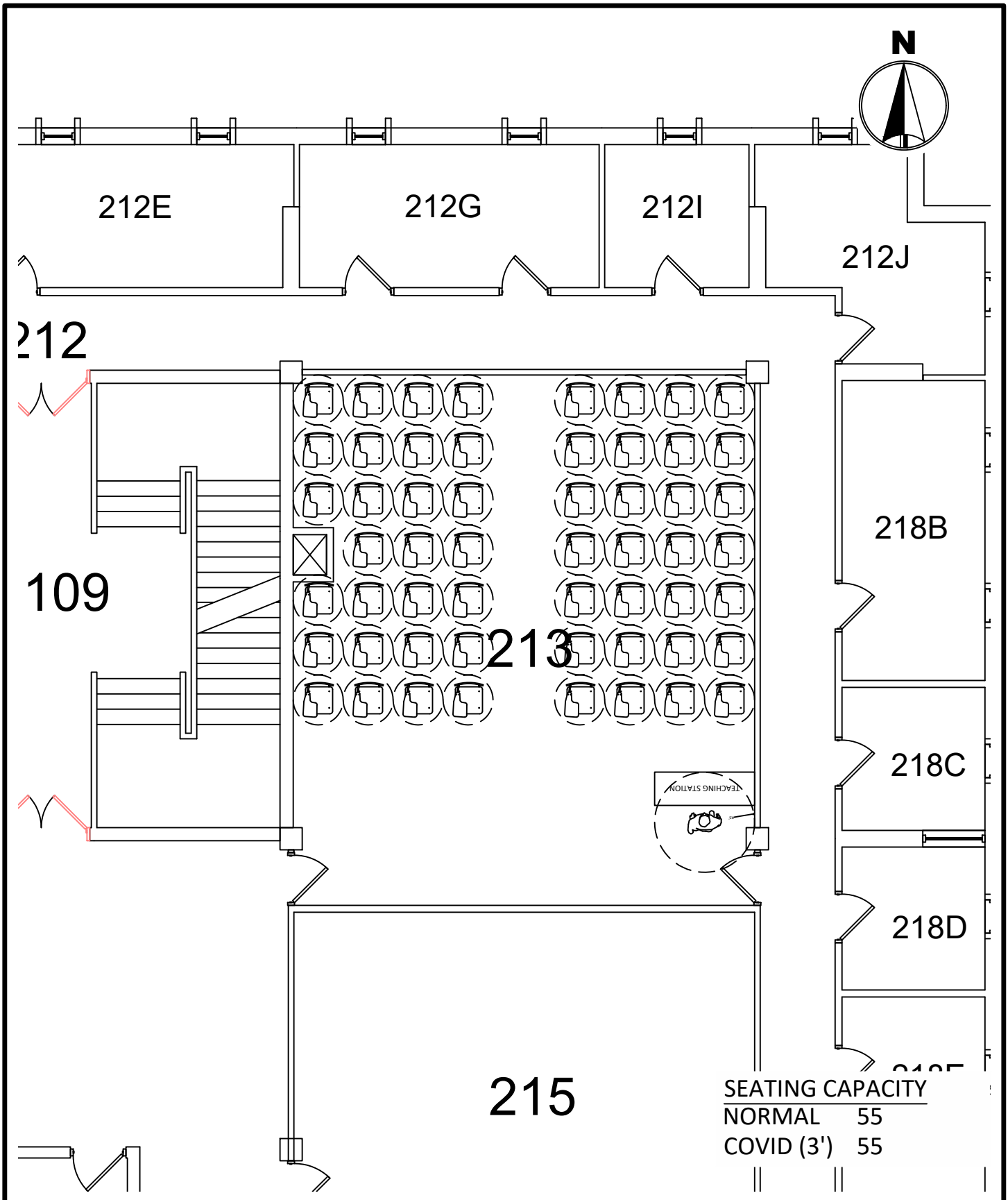

**MINNESOTA STATE UNIVERSITY**  
MANKATO  
**PLANNING & CONSTRUCTION**

**ARMSTRONG HALL 213**  
COVID SEATING LAYOUT  
3' SOCIAL DISTANCE

DRAWN BY: N. HUETTL

March 2021

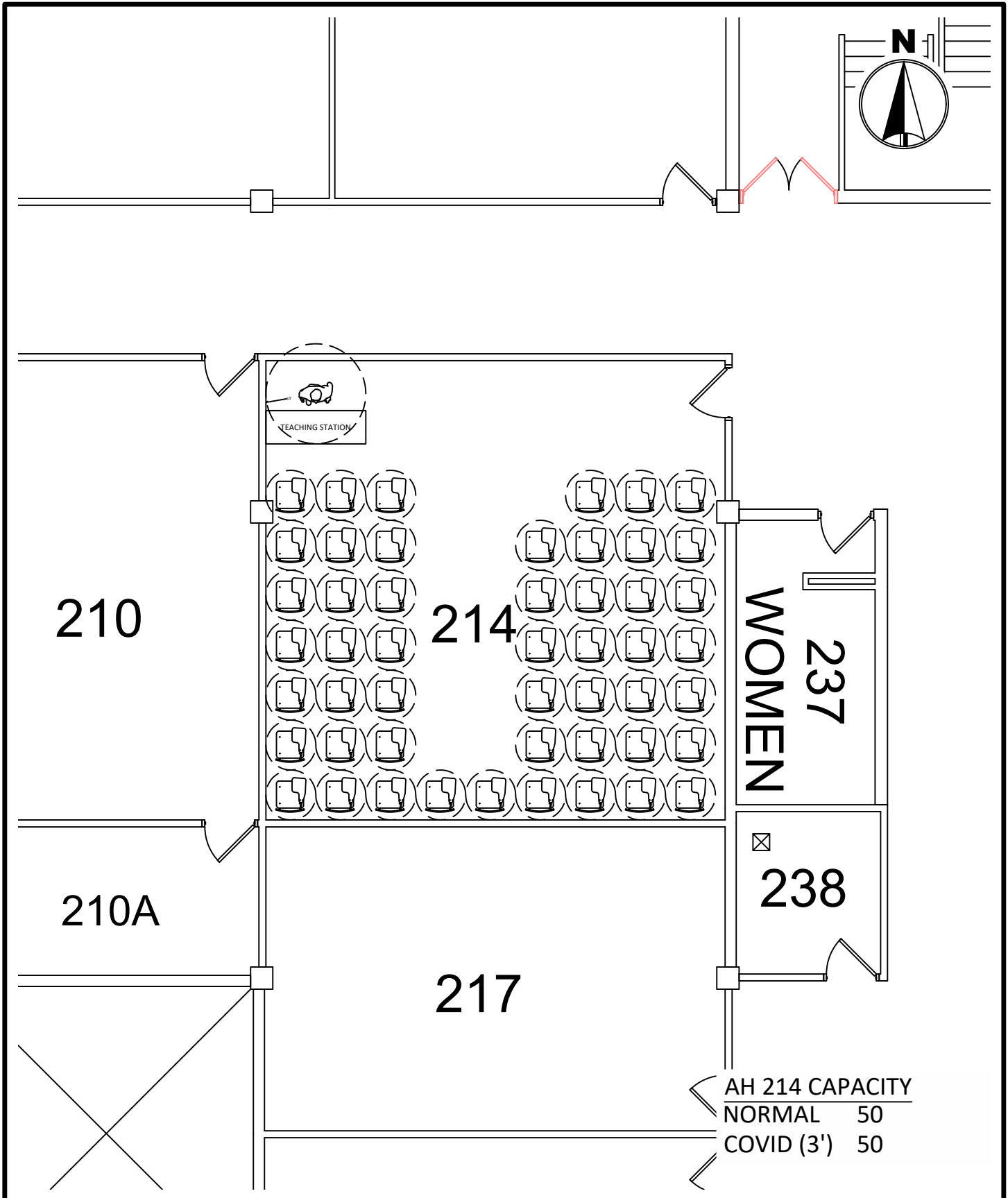

MINNESOTA STATE  
UNIVERSITY  
MANKATO  
PLANNING & CONSTRUCTION

ARMSTRONG HALL 214  
COVID SEATING LAYOUT  
3' SOCIAL DISTANCE

DRAWN BY: N. HUETTL March 2021

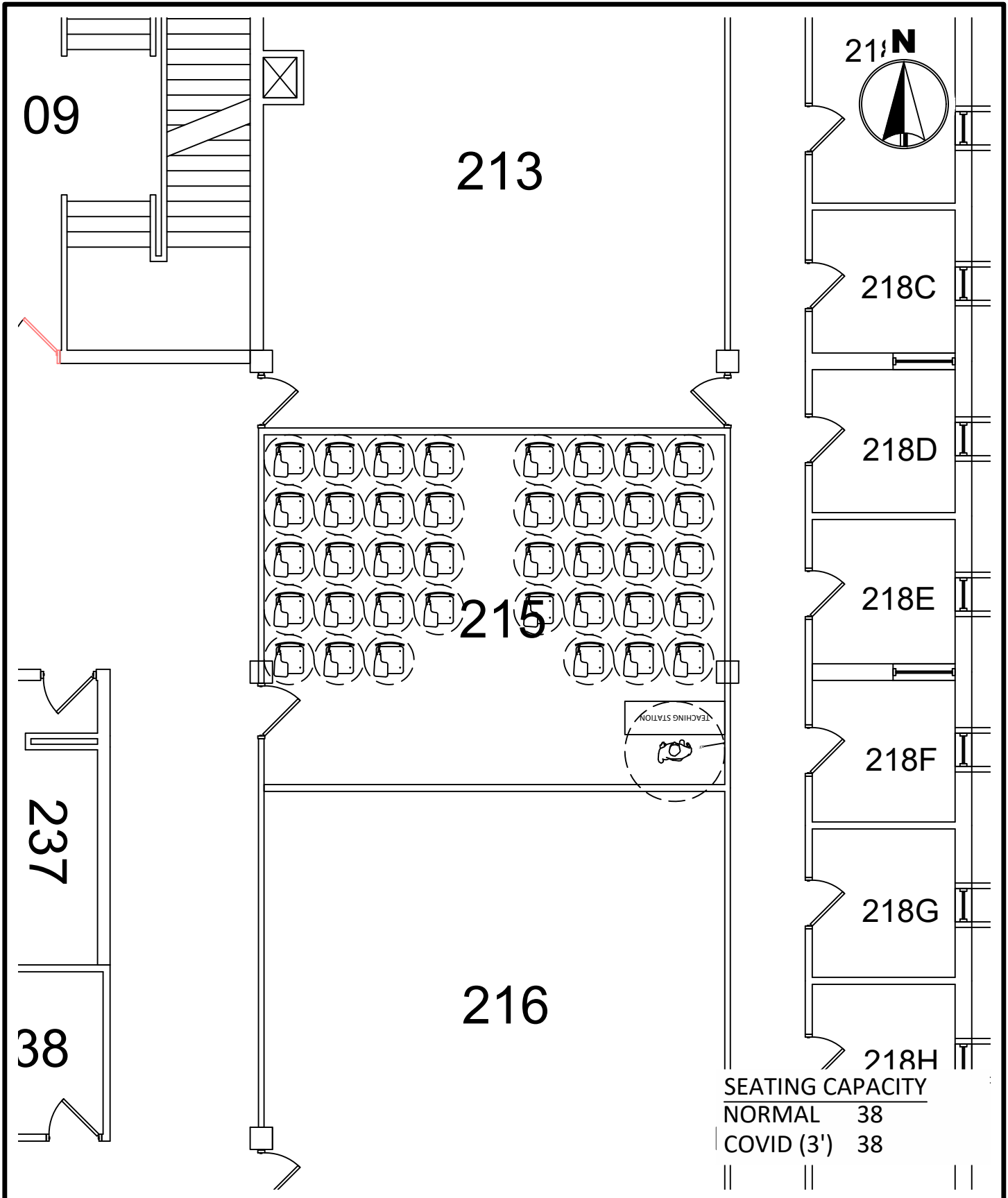

SEATING CAPACITY	
NORMAL	38
COVID (3')	38



**MINNESOTA STATE UNIVERSITY**  
MANKATO  
PLANNING & CONSTRUCTION

**ARMSTRONG HALL 215**  
COVID SEATING LAYOUT  
3' SOCIAL DISTANCE

DRAWN BY: N. HUETTL March 2021

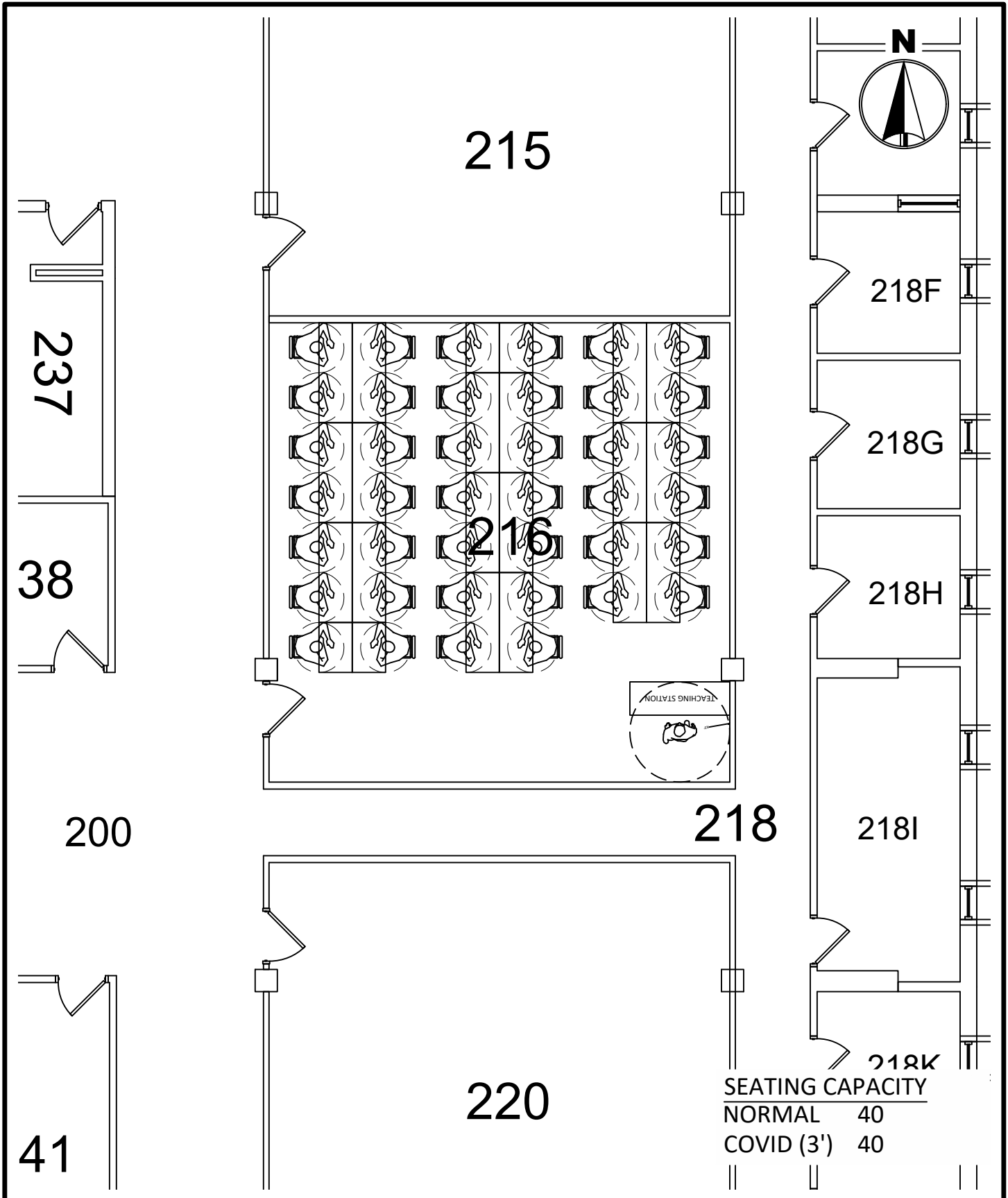

SEATING CAPACITY	
NORMAL	40
COVID (3')	40



MINNESOTA STATE UNIVERSITY  
MANKATO  
PLANNING & CONSTRUCTION

ARMSTRONG HALL 216  
COVID SEATING LAYOUT  
3' SOCIAL DISTANCE  
DRAWN BY: N. HUETTL March 2021

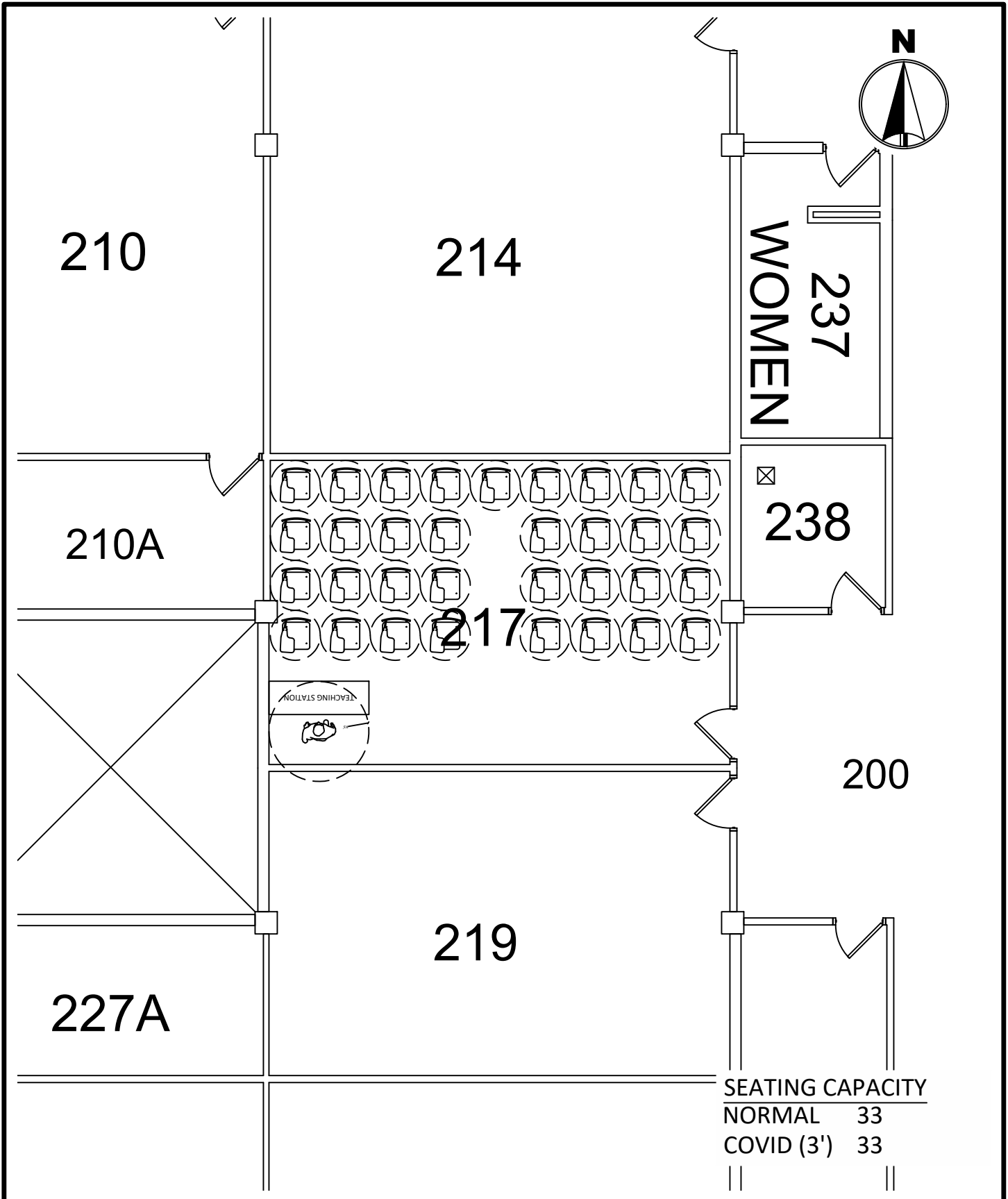

MINNESOTA STATE  
UNIVERSITY  
MANKATO  
PLANNING & CONSTRUCTION

ARMSTRONG HALL 217  
COVID SEATING LAYOUT  
3' SOCIAL DISTANCE

DRAWN BY: N. HUETTL

March 2021



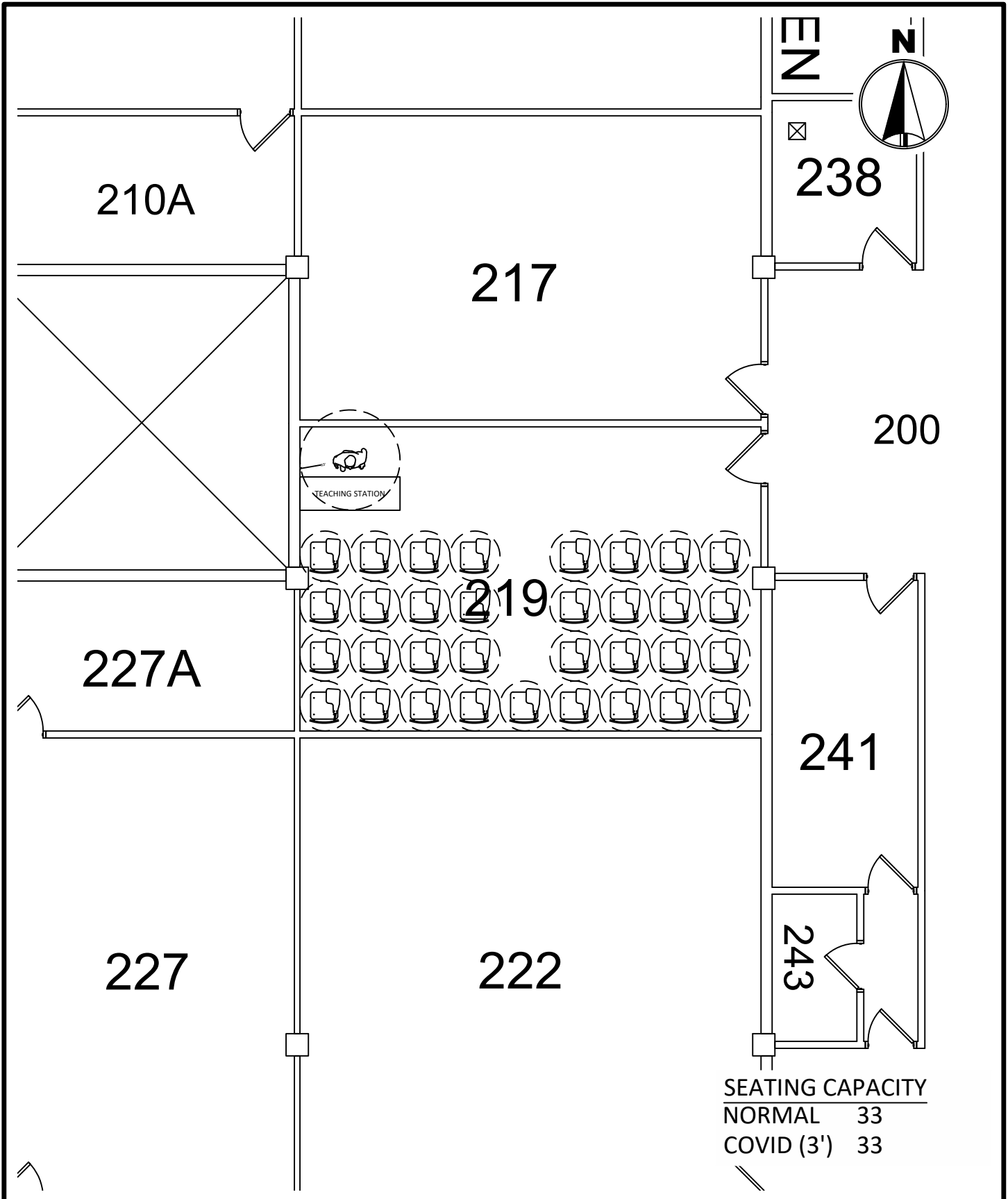

MINNESOTA STATE  
 UNIVERSITY  
 MANKATO  
 PLANNING & CONSTRUCTION

ARMSTRONG HALL 219  
 COVID SEATING LAYOUT  
 3' SOCIAL DISTANCE

DRAWN BY: N. HUETTL

March 2021

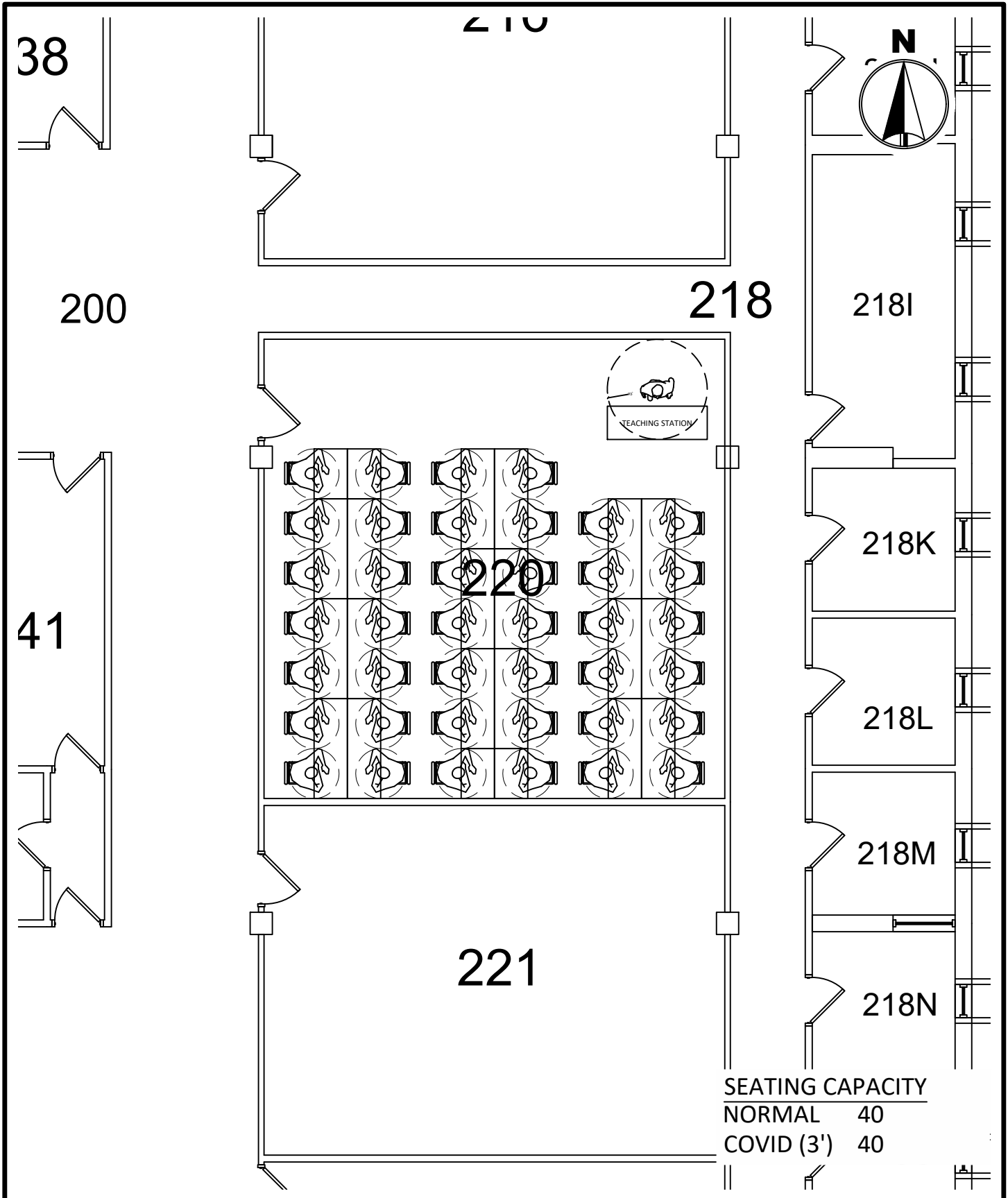

MINNESOTA STATE  
UNIVERSITY  
MANKATO  
PLANNING & CONSTRUCTION

ARMSTRONG HALL 220  
COVID SEATING LAYOUT  
3' SOCIAL DISTANCE

DRAWN BY: N. HUETTL

March 2021

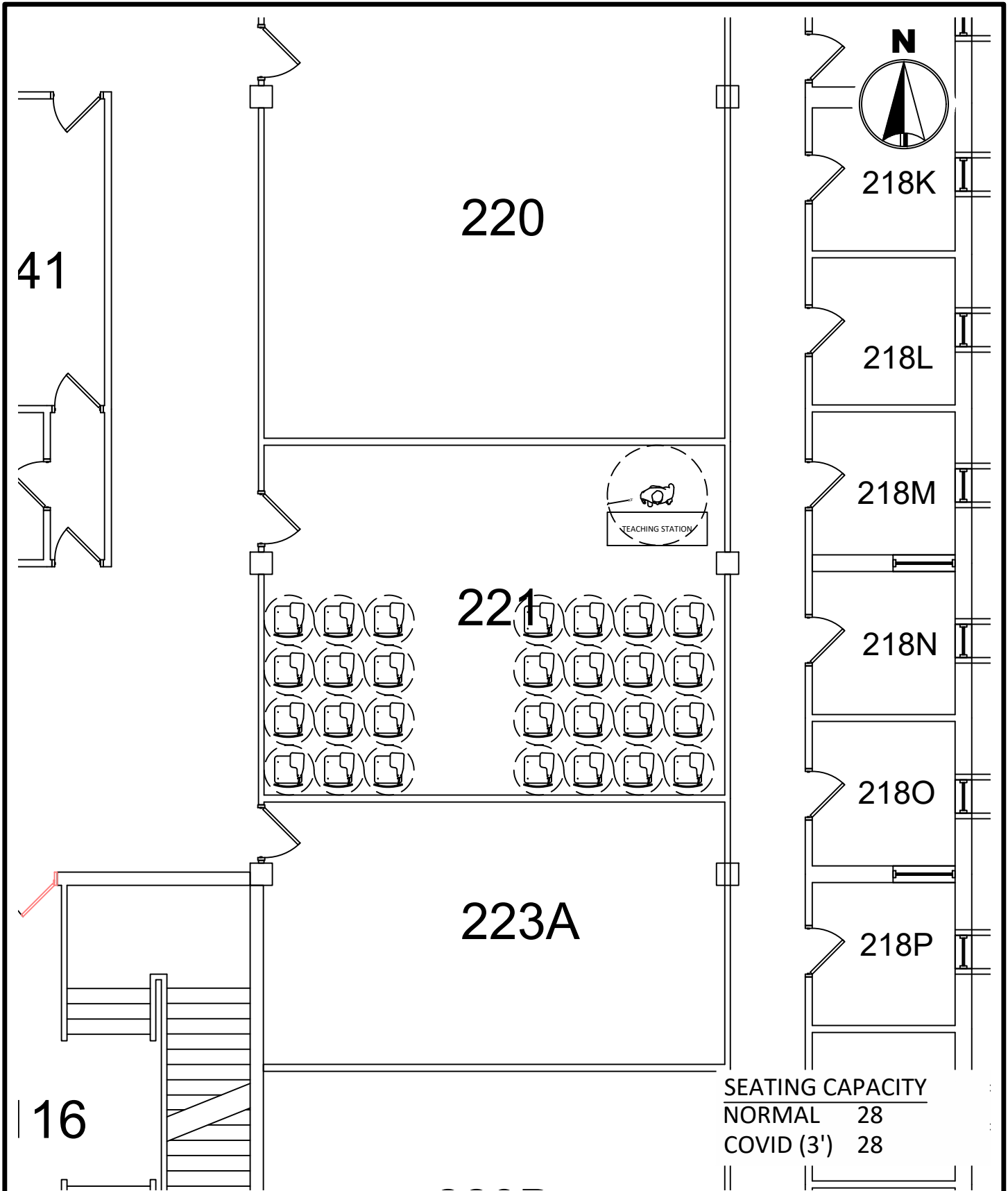

MINNESOTA STATE UNIVERSITY  
 MANKATO  
 PLANNING & CONSTRUCTION

ARMSTRONG HALL 221  
 COVID SEATING LAYOUT  
 3' SOCIAL DISTANCE

DRAWN BY: N. HUETTL March 2021

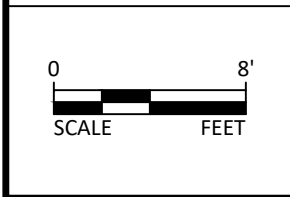
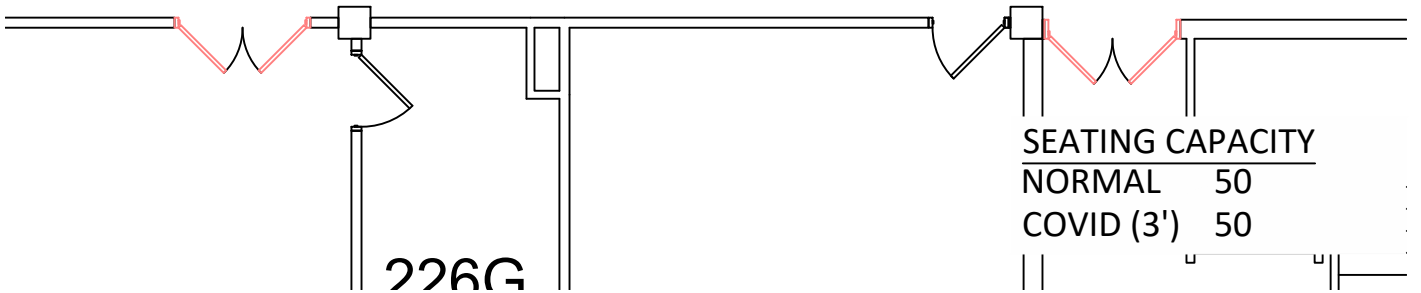
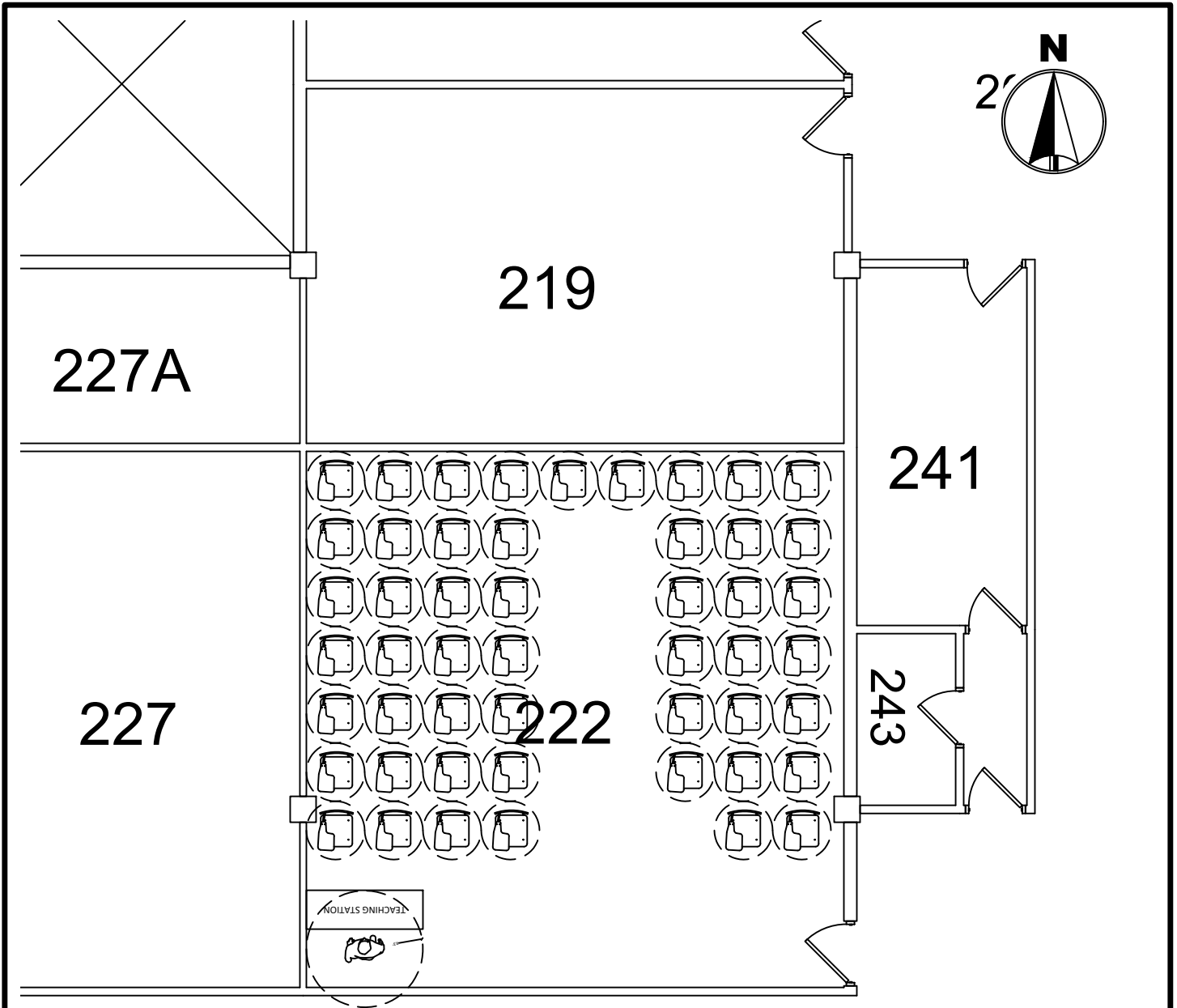

MINNESOTA STATE UNIVERSITY  
MANKATO  
PLANNING & CONSTRUCTION

ARMSTRONG HALL 222  
COVID SEATING LAYOUT  
3' SOCIAL DISTANCE

DRAWN BY: N. HUETTL March 2021

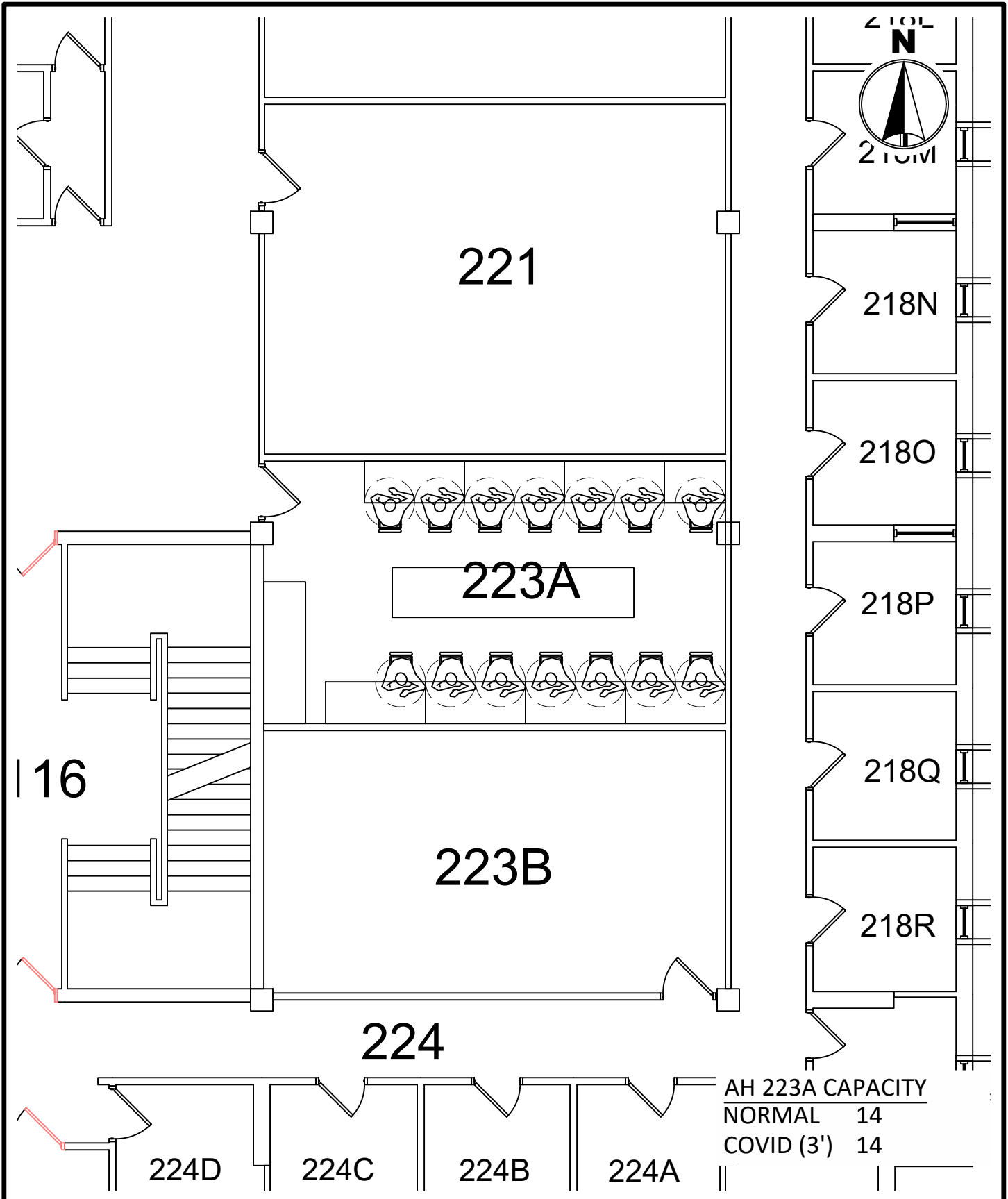

MINNESOTA STATE  
UNIVERSITY  
MANKATO  
PLANNING & CONSTRUCTION

ARMSTRONG HALL 223A  
COVID SEATING LAYOUT  
3' SOCIAL DISTANCE

DRAWN BY: N. HUETTL

March 2021

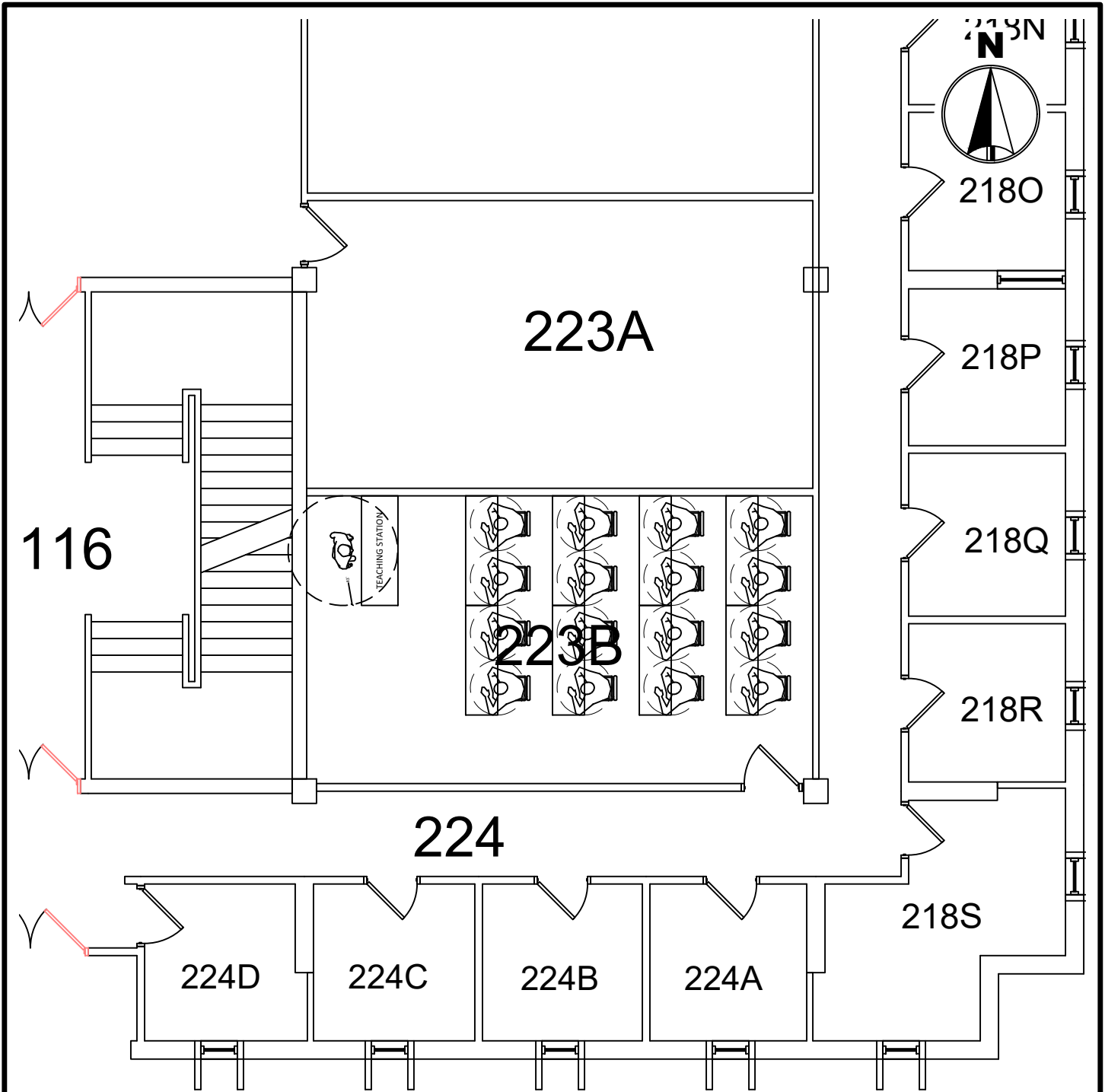

SEATING CAPACITY  
 NORMAL 27  
 COVID (3') 16



MINNESOTA STATE  
 UNIVERSITY  
 MANKATO  
 PLANNING & CONSTRUCTION

ARMSTRONG HALL 223B  
 COVID SEATING LAYOUT  
 3' SOCIAL DISTANCE

DRAWN BY: N. HUETTL

March 2021

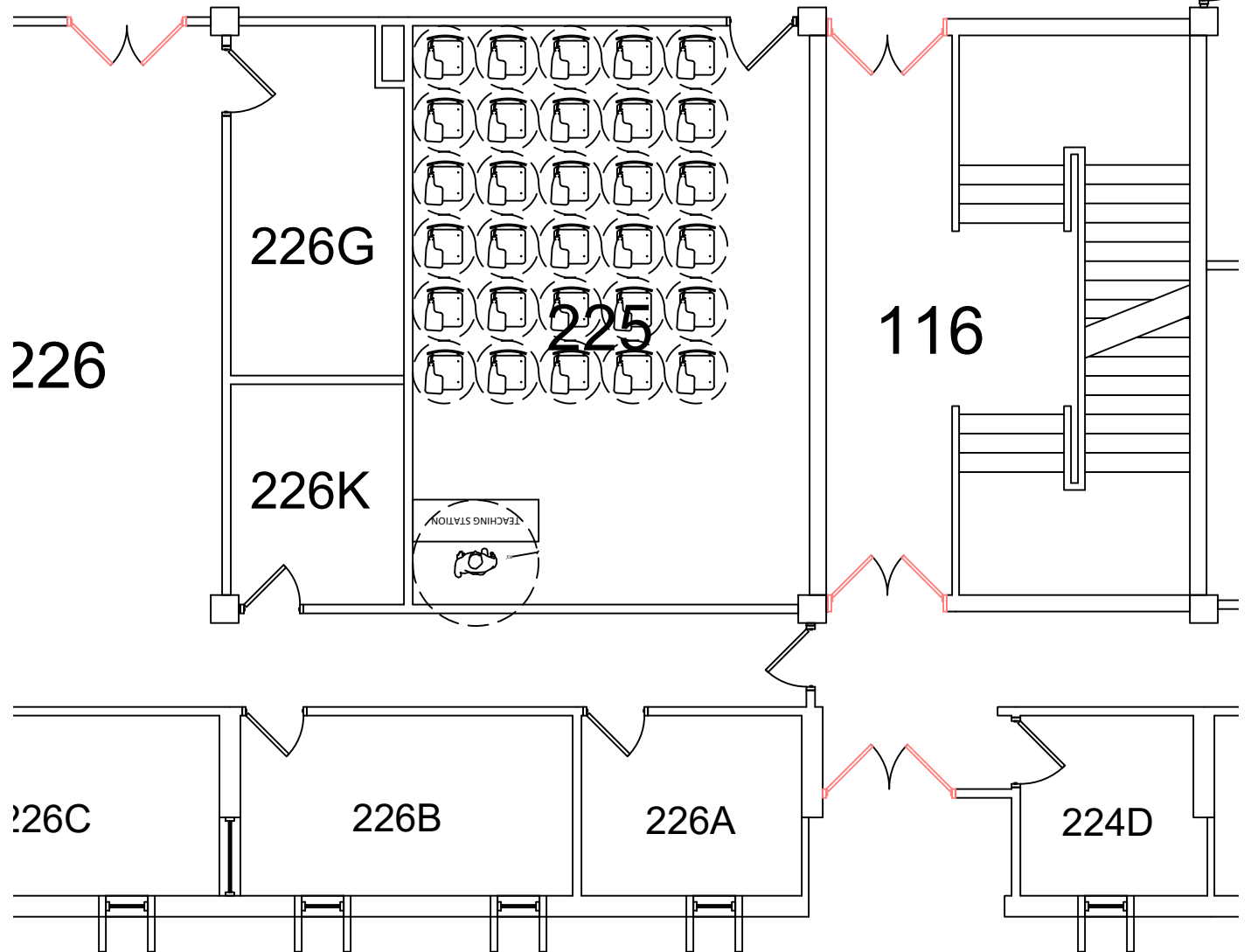
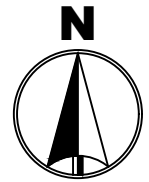

SEATING CAPACITY  
NORMAL 30  
COVID (3') 30



MINNESOTA STATE  
UNIVERSITY  
MANKATO  
PLANNING & CONSTRUCTION

ARMSTRONG HALL 225  
COVID SEATING LAYOUT  
3' SOCIAL DISTANCE

DRAWN BY: N. HUETTL

March 2021

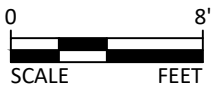
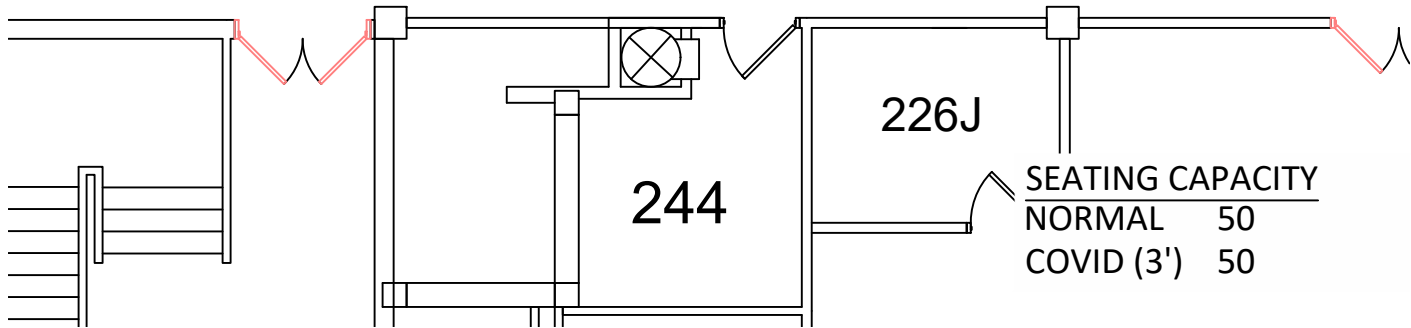
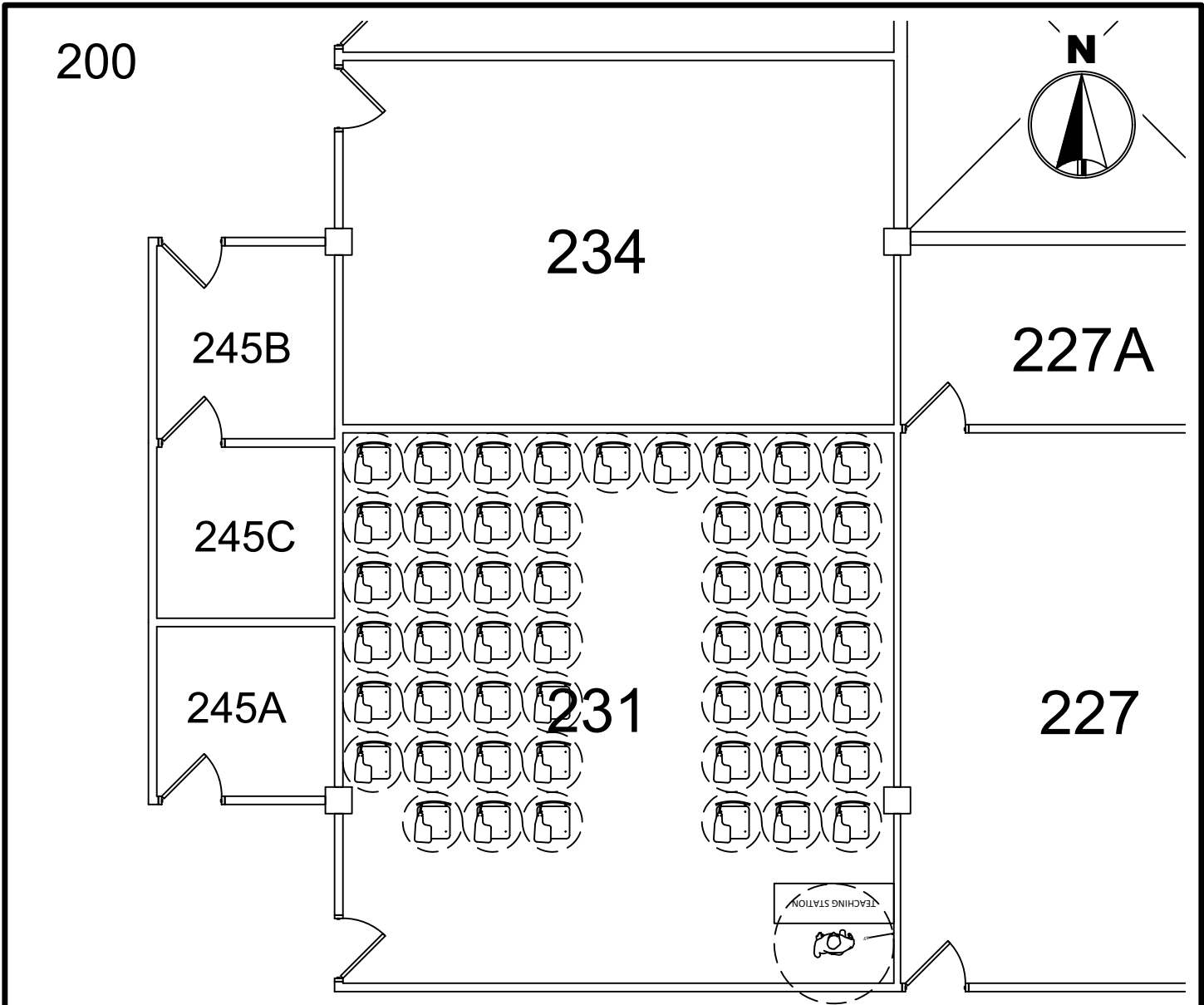

**MINNESOTA STATE UNIVERSITY**  
MANKATO  
PLANNING & CONSTRUCTION

**ARMSTRONG HALL 231**  
COVID SEATING LAYOUT  
3' SOCIAL DISTANCE

DRAWN BY: N. HUETTL

March 2021



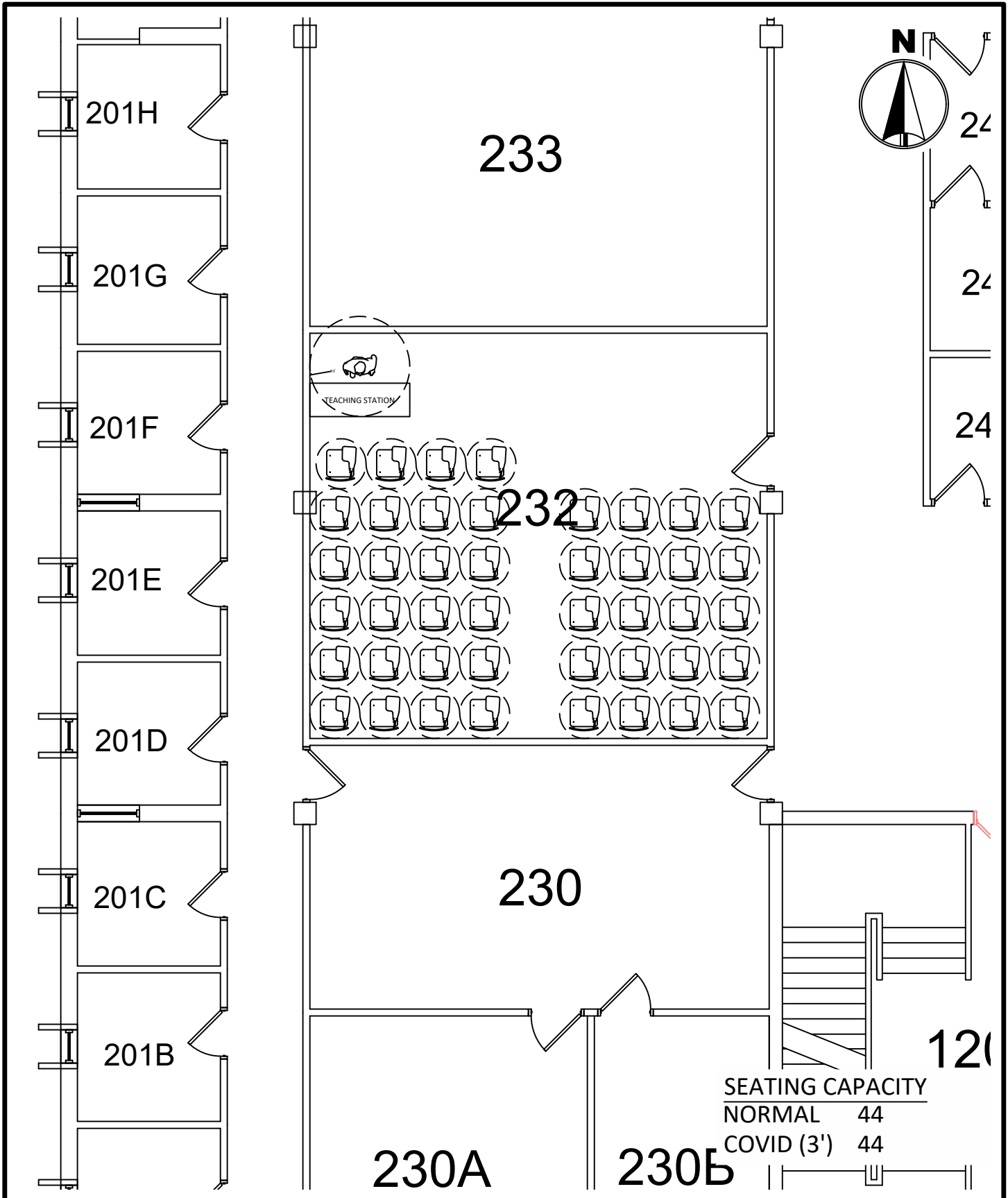

MINNESOTA STATE  
UNIVERSITY  
MANKATO  
PLANNING & CONSTRUCTION

ARMSTRONG HALL 232  
COVID SEATING LAYOUT  
3' SOCIAL DISTANCE  
DRAWN BY: N. HUETTL  
March 2021

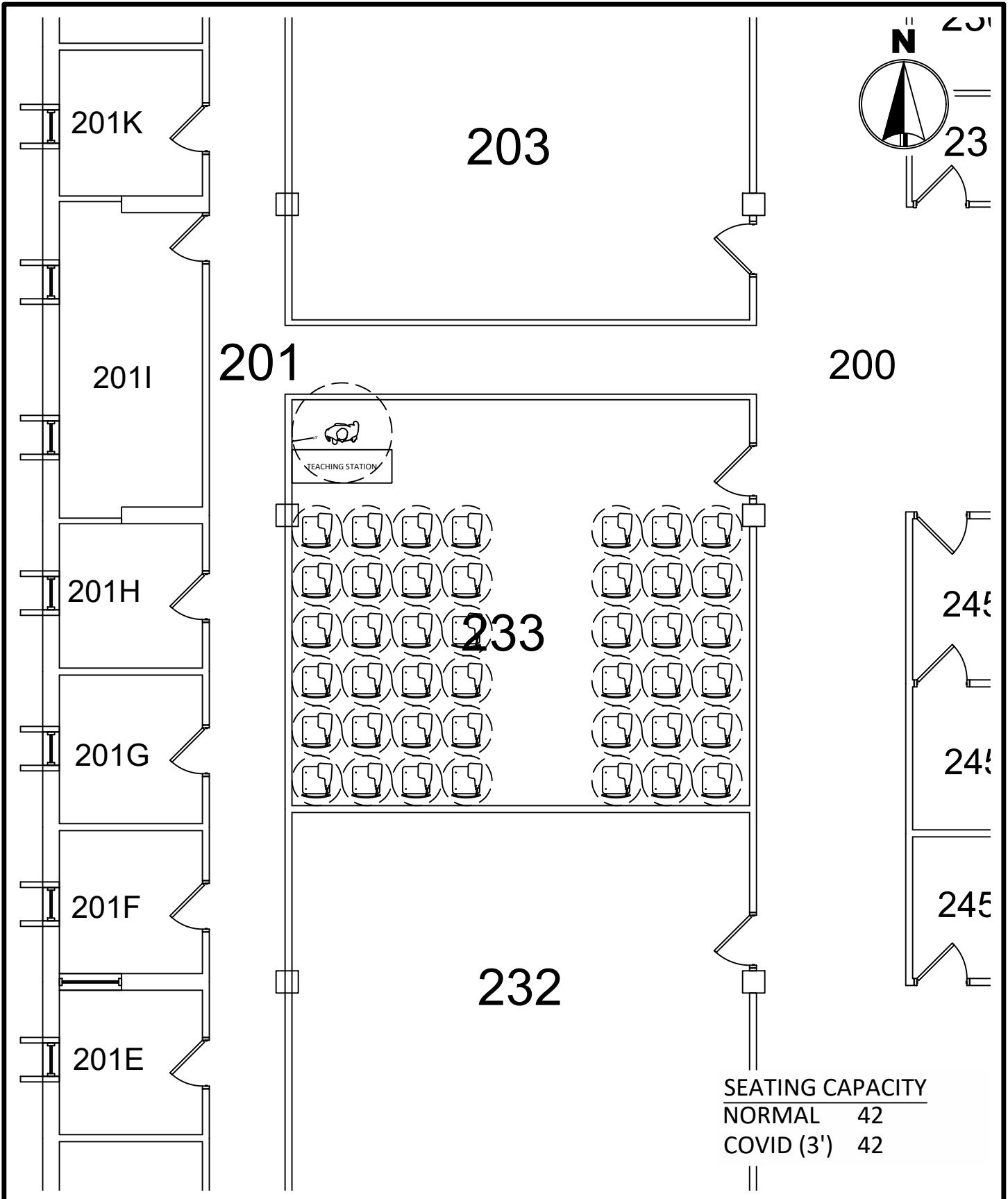

SEATING CAPACITY	
NORMAL	42
COVID (3')	42



**MINNESOTA STATE UNIVERSITY**  
MANKATO  
PLANNING & CONSTRUCTION

**ARMSTRONG HALL 233**  
COVID SEATING LAYOUT  
3' SOCIAL DISTANCE

DRAWN BY: N. HUETTL March 2021

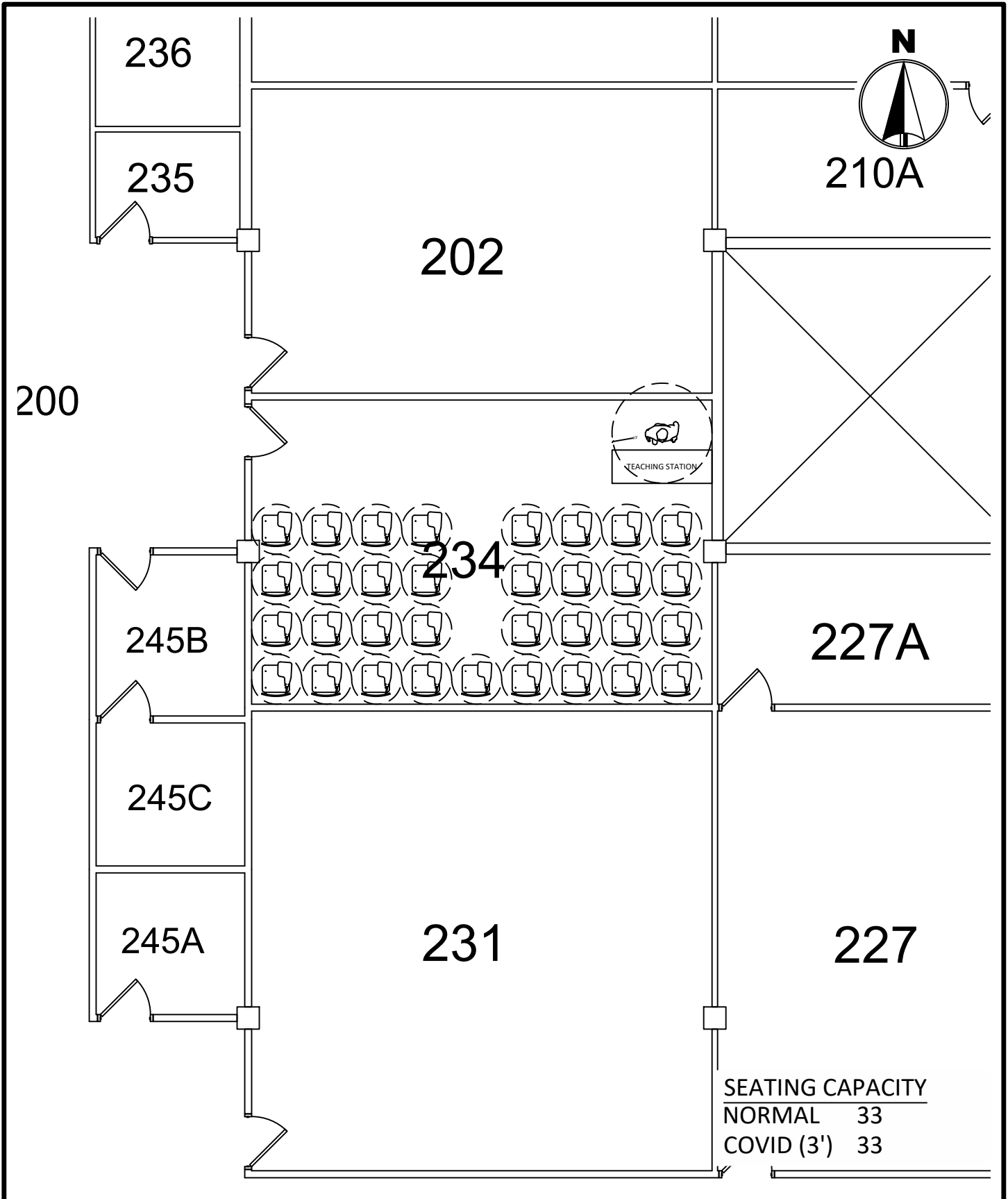

MINNESOTA STATE  
UNIVERSITY  
MANKATO  
PLANNING & CONSTRUCTION

ARMSTRONG HALL 234  
COVID SEATING LAYOUT  
3' SOCIAL DISTANCE

DRAWN BY: N. HUETTL

March 2021

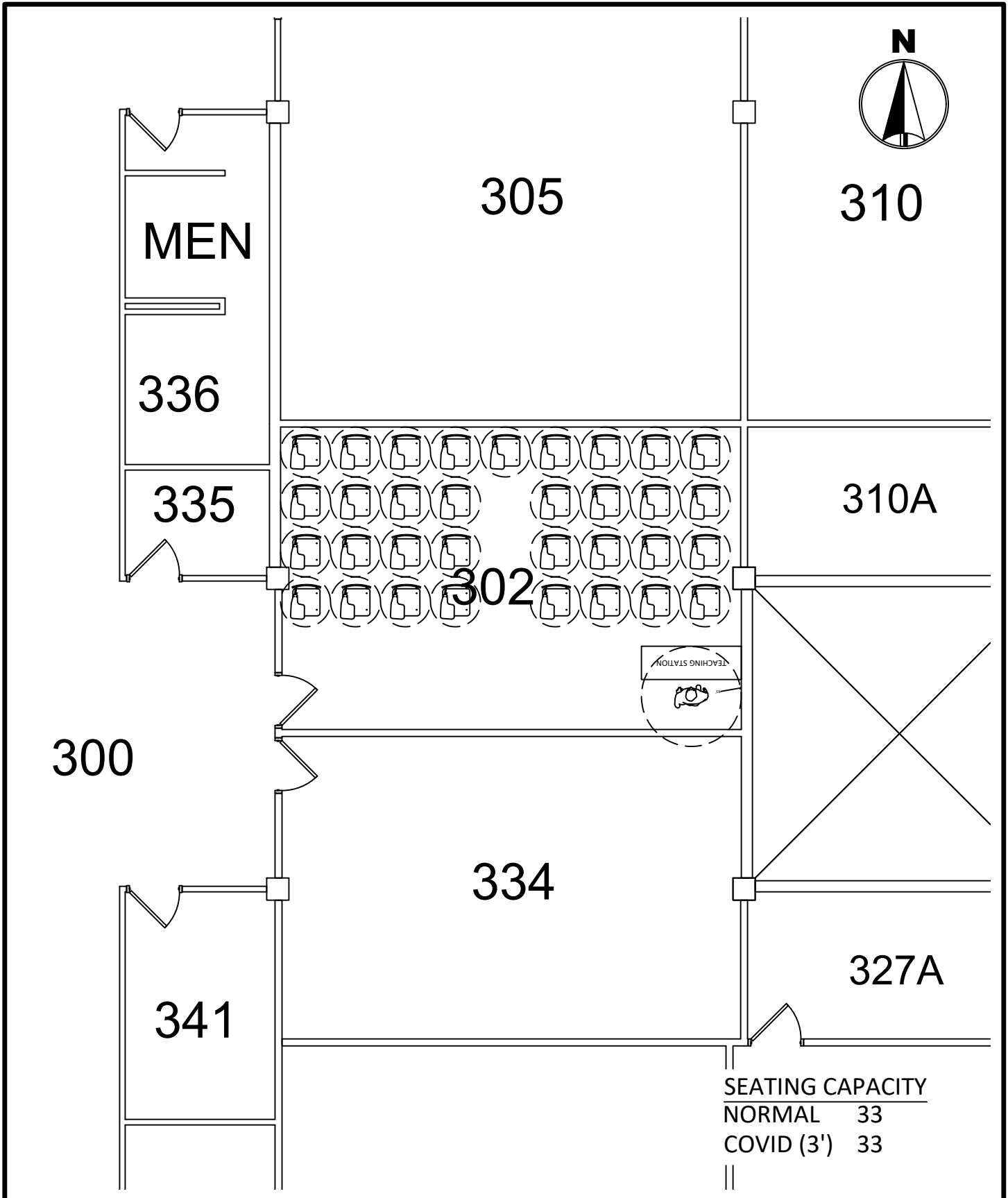

MINNESOTA STATE UNIVERSITY  
 MANKATO  
 PLANNING & CONSTRUCTION

ARMSTRONG HALL 302  
 COVID SEATING LAYOUT  
 3' SOCIAL DISTANCE  
 DRAWN BY: N. HUETTL March 2021

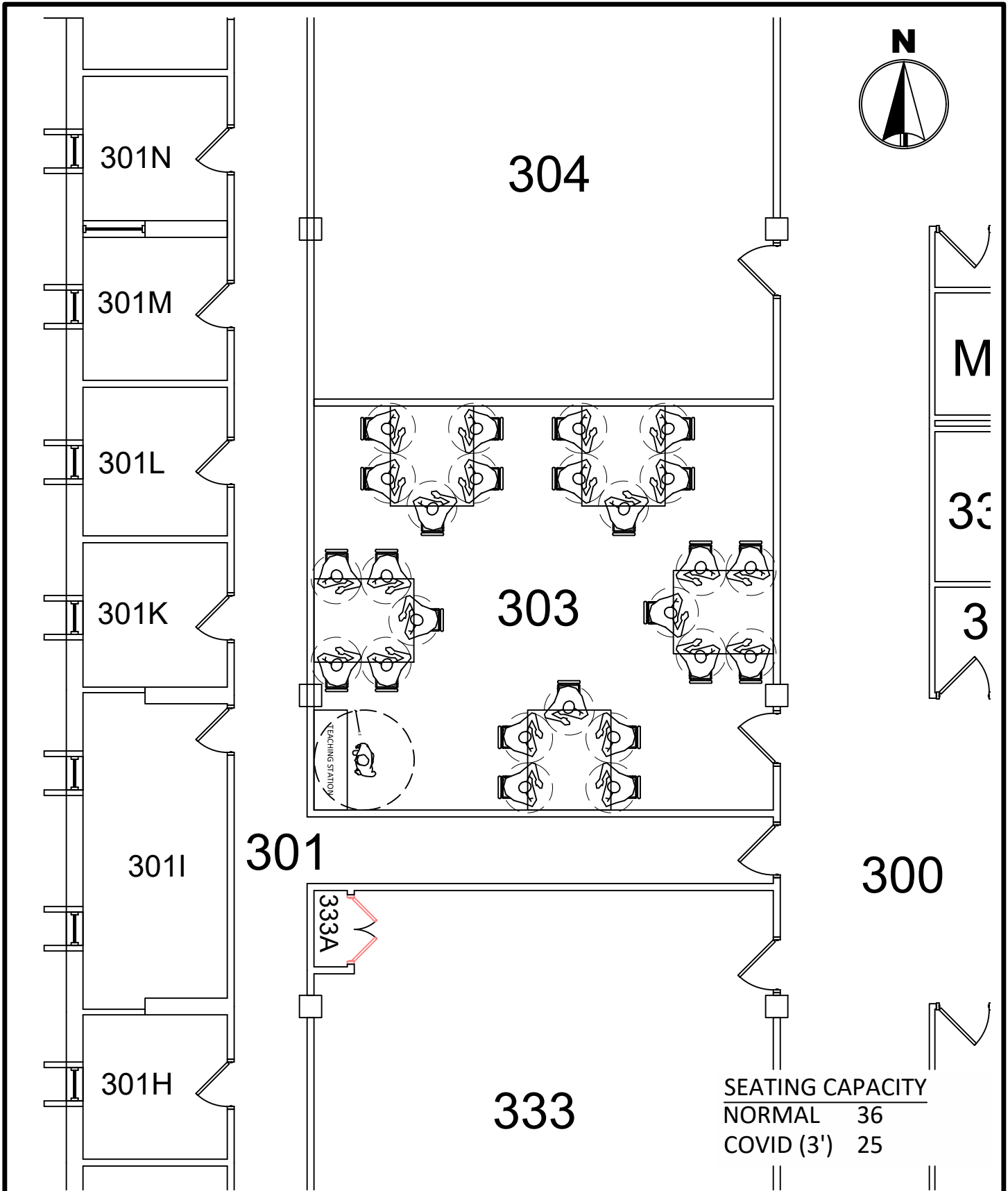

MINNESOTA STATE  
UNIVERSITY  
MANKATO  
PLANNING & CONSTRUCTION

ARMSTRONG HALL 303  
COVID SEATING LAYOUT  
3' SOCIAL DISTANCE  
DRAWN BY: N. HUETTL  
March 2021

306

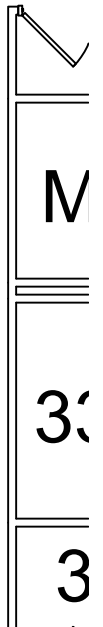
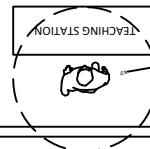
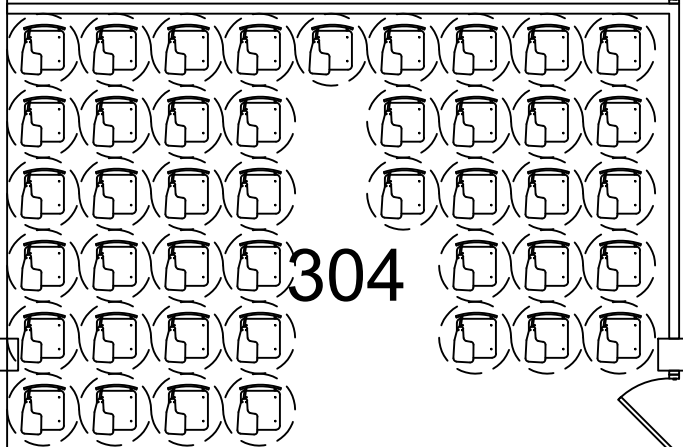
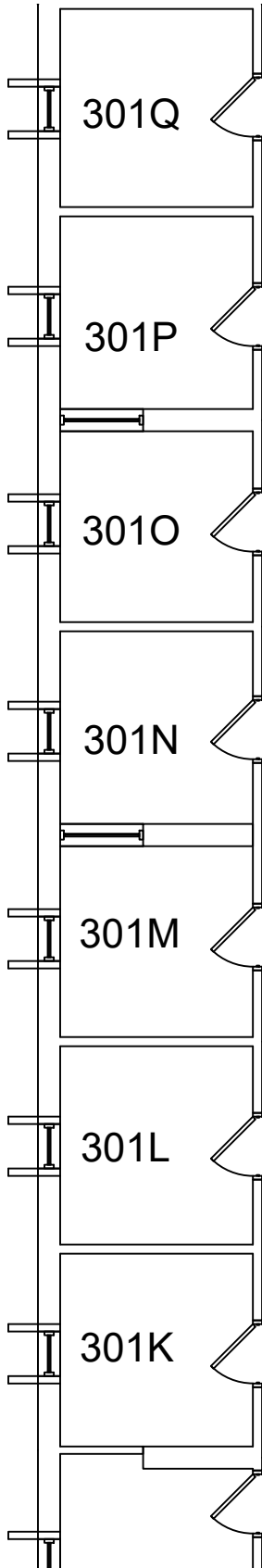
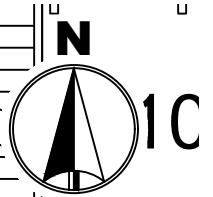

303

SEATING CAPACITY	
NORMAL	43
COVID (3')	43

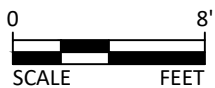

MINNESOTA STATE UNIVERSITY  
MANKATO

PLANNING & CONSTRUCTION

ARMSTRONG HALL 304  
COVID SEATING LAYOUT  
3' SOCIAL DISTANCE

DRAWN BY: N. HUETTL

March 2021

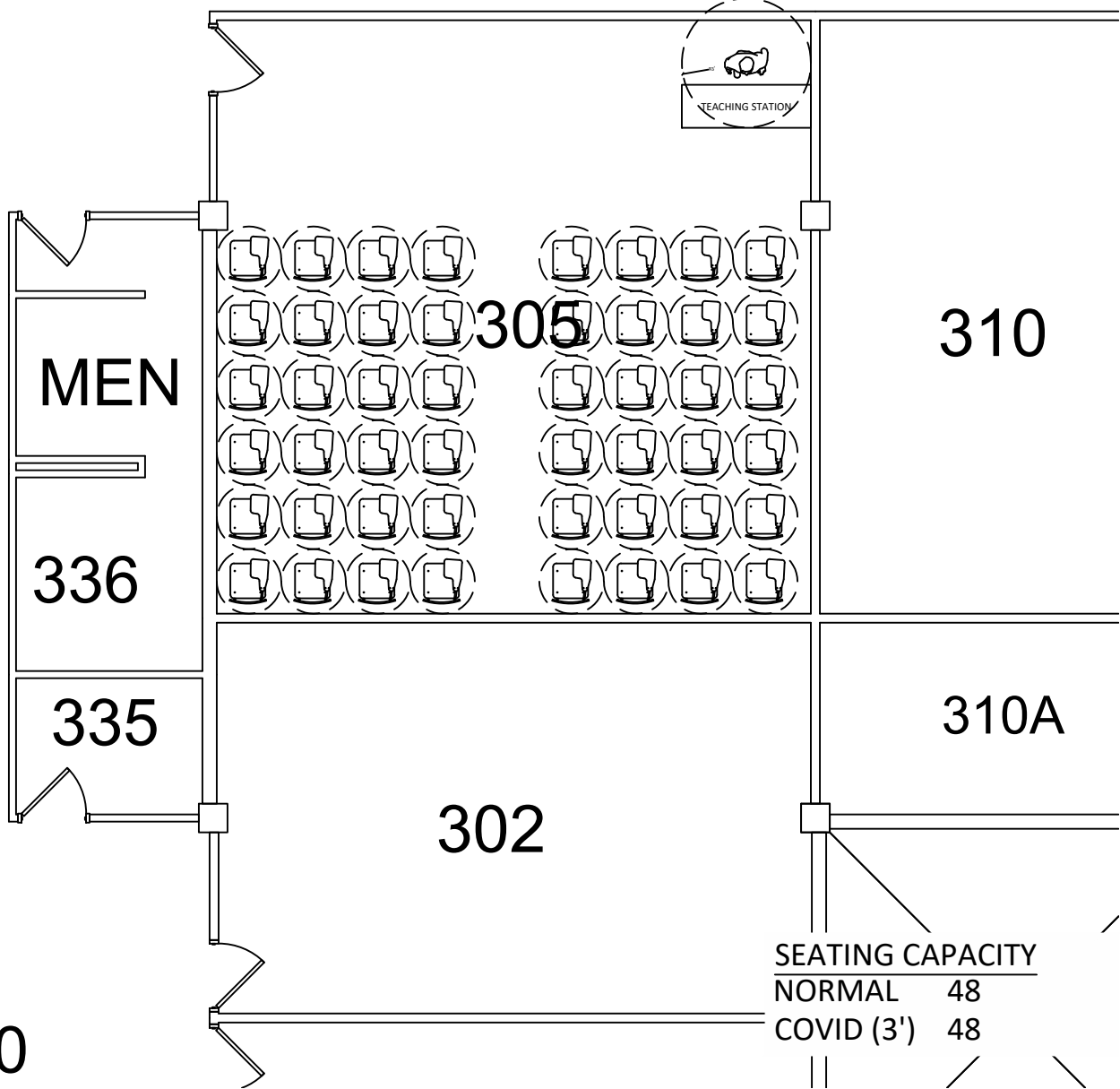
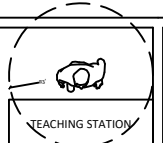
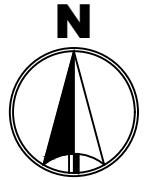

SEATING CAPACITY	
NORMAL	48
COVID (3')	48



**MINNESOTA STATE UNIVERSITY**  
MANKATO  
PLANNING & CONSTRUCTION

**ARMSTRONG HALL 305**  
COVID SEATING LAYOUT  
3' SOCIAL DISTANCE

DRAWN BY: N. HUETTL March 2021

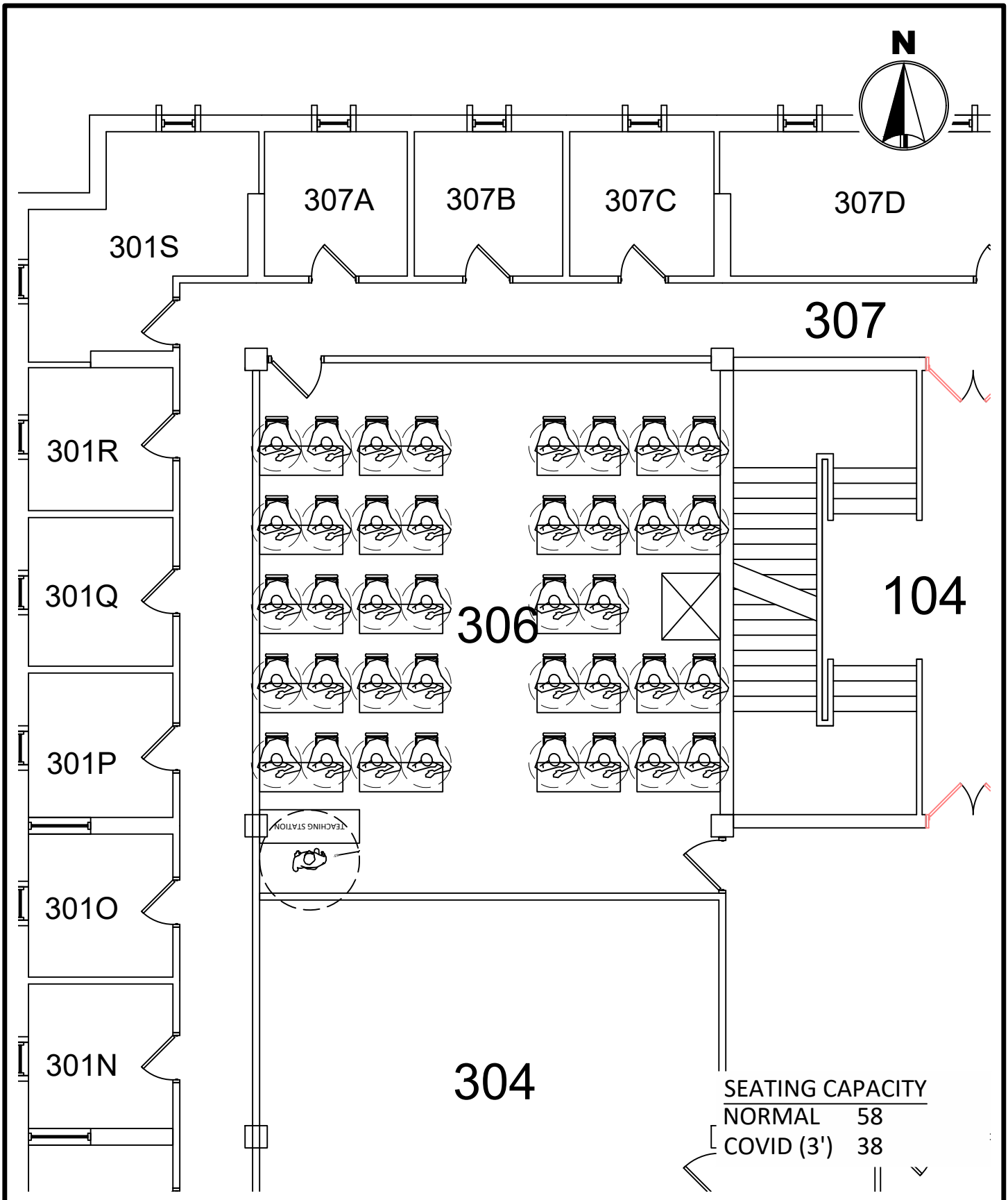

MINNESOTA STATE  
 UNIVERSITY  
 MANKATO  
 PLANNING & CONSTRUCTION

ARMSTRONG HALL 306  
 COVID SEATING LAYOUT  
 3' SOCIAL DISTANCE

DRAWN BY: N. HUETTL

March 2021



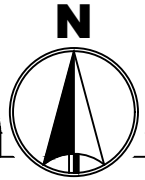

307D

307F

307G

307H

307I

312

307

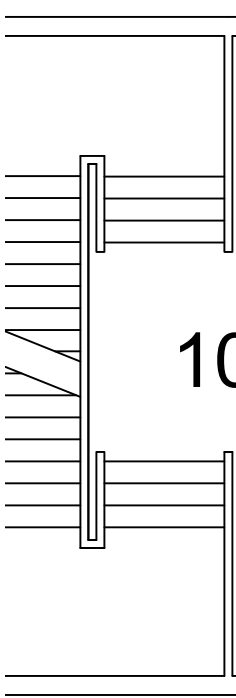

104

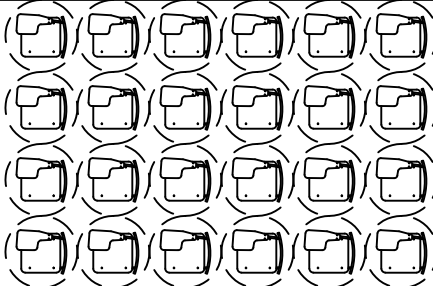

308

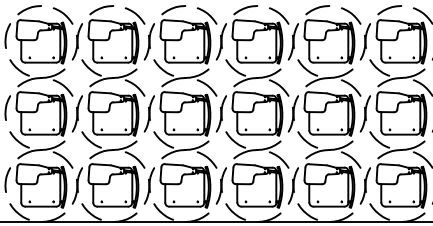

309

SEATING CAPACITY	
NORMAL	42
COVID (3')	42



MINNESOTA STATE UNIVERSITY  
MANKATO

PLANNING & CONSTRUCTION

ARMSTRONG HALL 308  
COVID SEATING LAYOUT  
3' SOCIAL DISTANCE

DRAWN BY: N. HUETTL

March 2021



307G

307H

307I

312A

312B

312C

308



309

311

SEATING CAPACITY	
NORMAL	40
COVID (3')	29



MINNESOTA STATE UNIVERSITY  
MANKATO

PLANNING & CONSTRUCTION

ARMSTRONG HALL 309  
COVID SEATING LAYOUT  
3' SOCIAL DISTANCE

DRAWN BY: N. HUETTL

March 2021

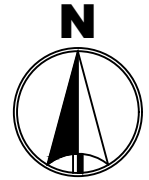

305

310

314

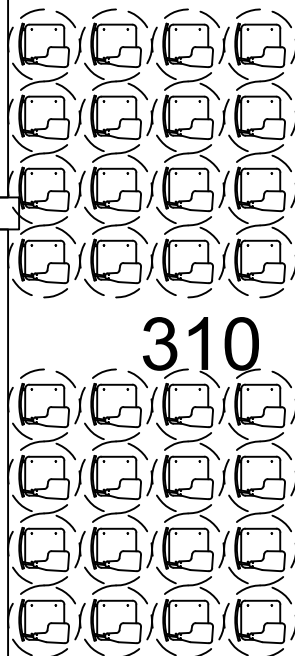

302

310A

317

SEATING CAPACITY	
NORMAL	32
COVID (3')	32



MINNESOTA STATE  
UNIVERSITY  
MANKATO  
PLANNING & CONSTRUCTION

ARMSTRONG HALL 310  
COVID SEATING LAYOUT  
3' SOCIAL DISTANCE

DRAWN BY: N. HUETTL

March 2021

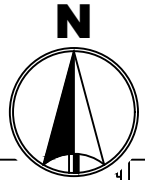

312A

312B

312C

312D

312E

309

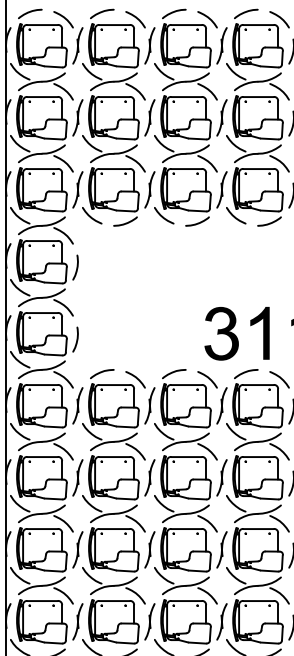

311

311A

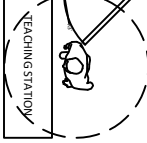

109

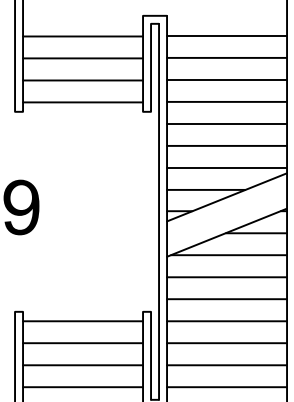

SEATING CAPACITY	
NORMAL	30
COVID (3')	30



**MINNESOTA STATE UNIVERSITY**  
MANKATO  
PLANNING & CONSTRUCTION

**ARMSTRONG HALL 311**  
COVID SEATING LAYOUT  
3' SOCIAL DISTANCE

DRAWN BY: N. HUETTL

March 2021

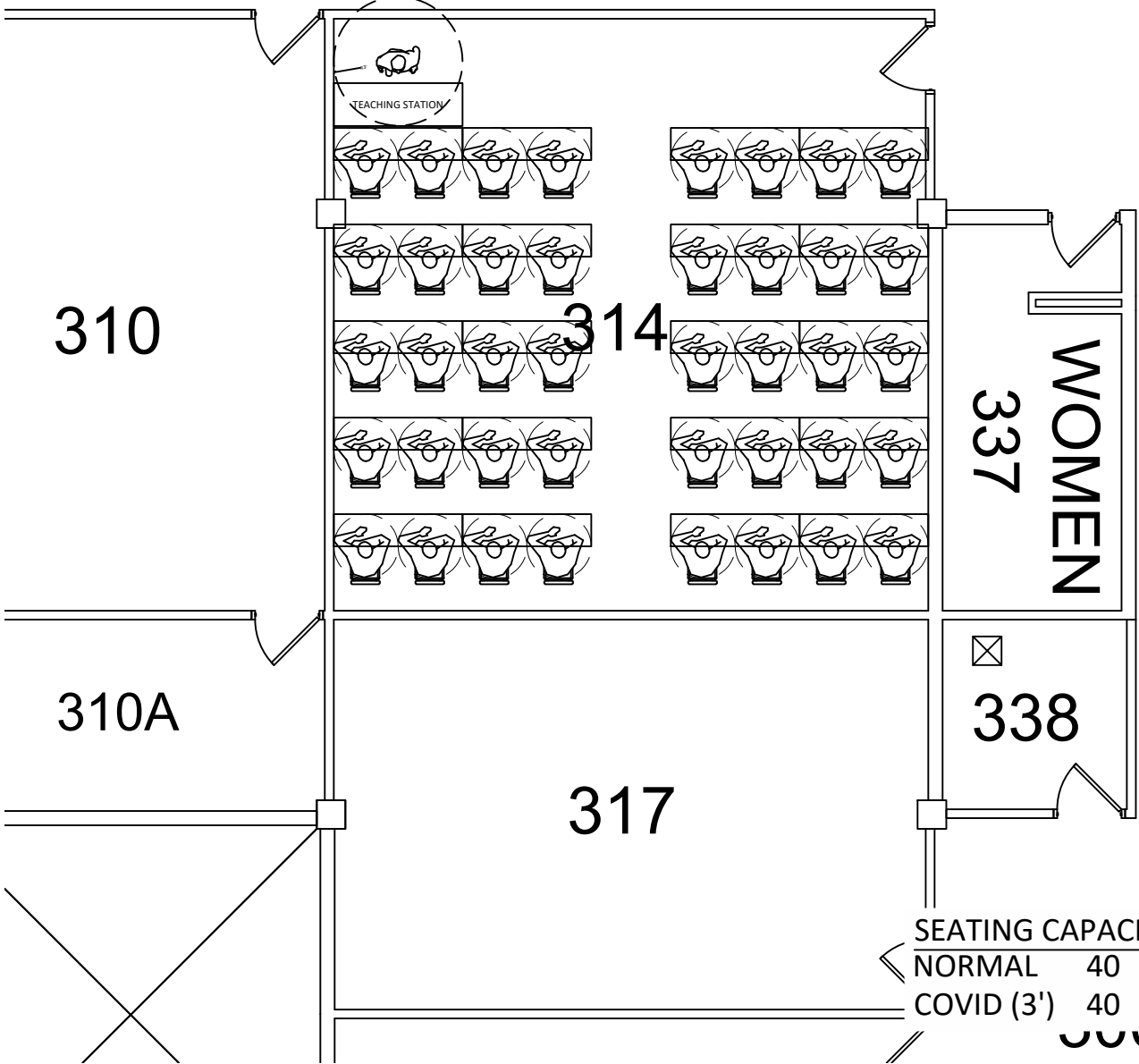
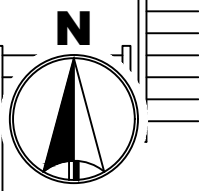

MINNESOTA STATE  
 UNIVERSITY  
 MANKATO  
 PLANNING & CONSTRUCTION

ARMSTRONG HALL 314  
 COVID SEATING LAYOUT  
 3' SOCIAL DISTANCE

DRAWN BY: N. HUETTL March 2021

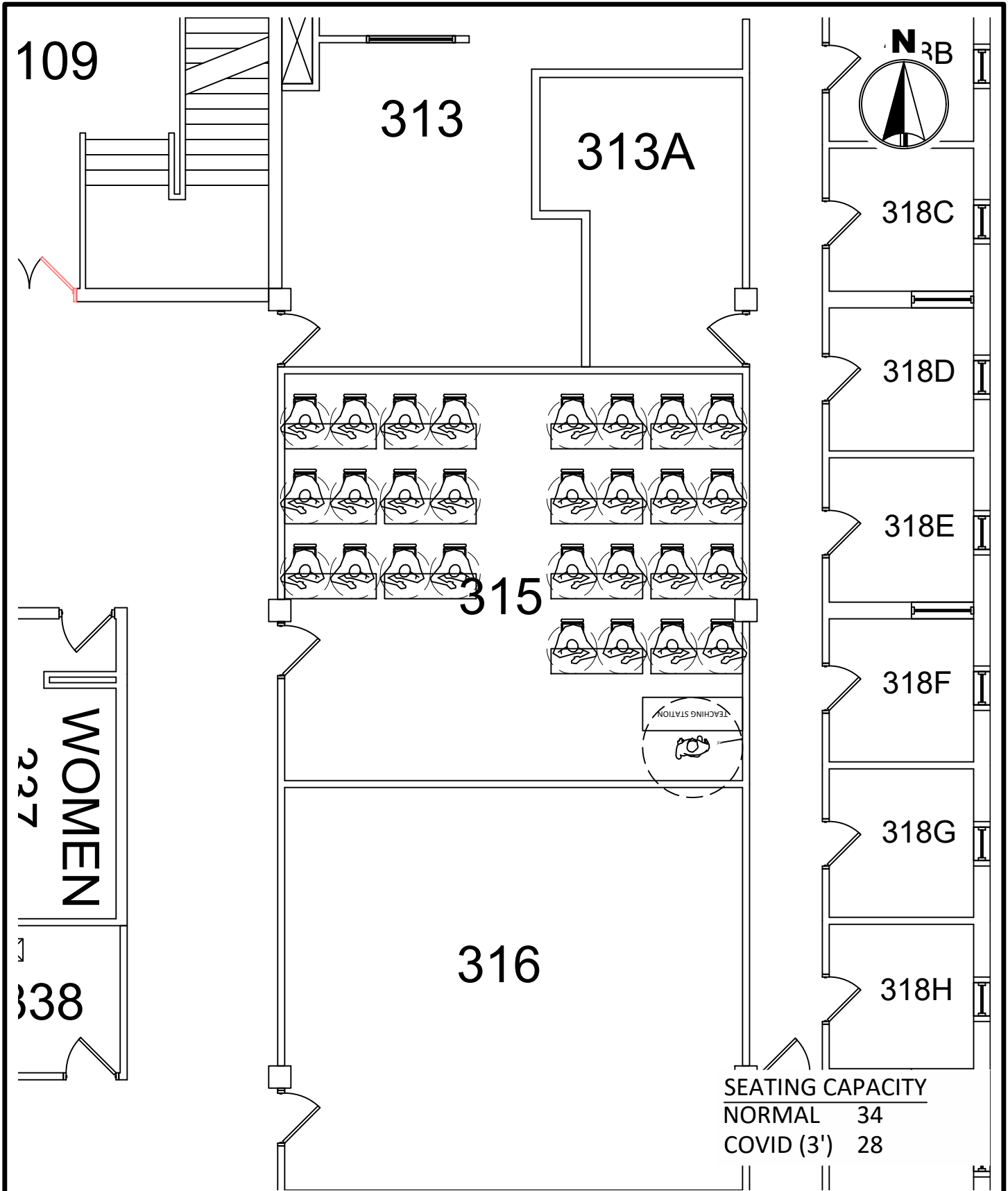

227  
WOMEN

338

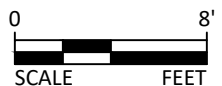

MINNESOTA STATE  
UNIVERSITY  
MANKATO  
PLANNING & CONSTRUCTION

ARMSTRONG HALL 315  
COVID SEATING LAYOUT  
3' SOCIAL DISTANCE

DRAWN BY: N. HUETTL

March 2021

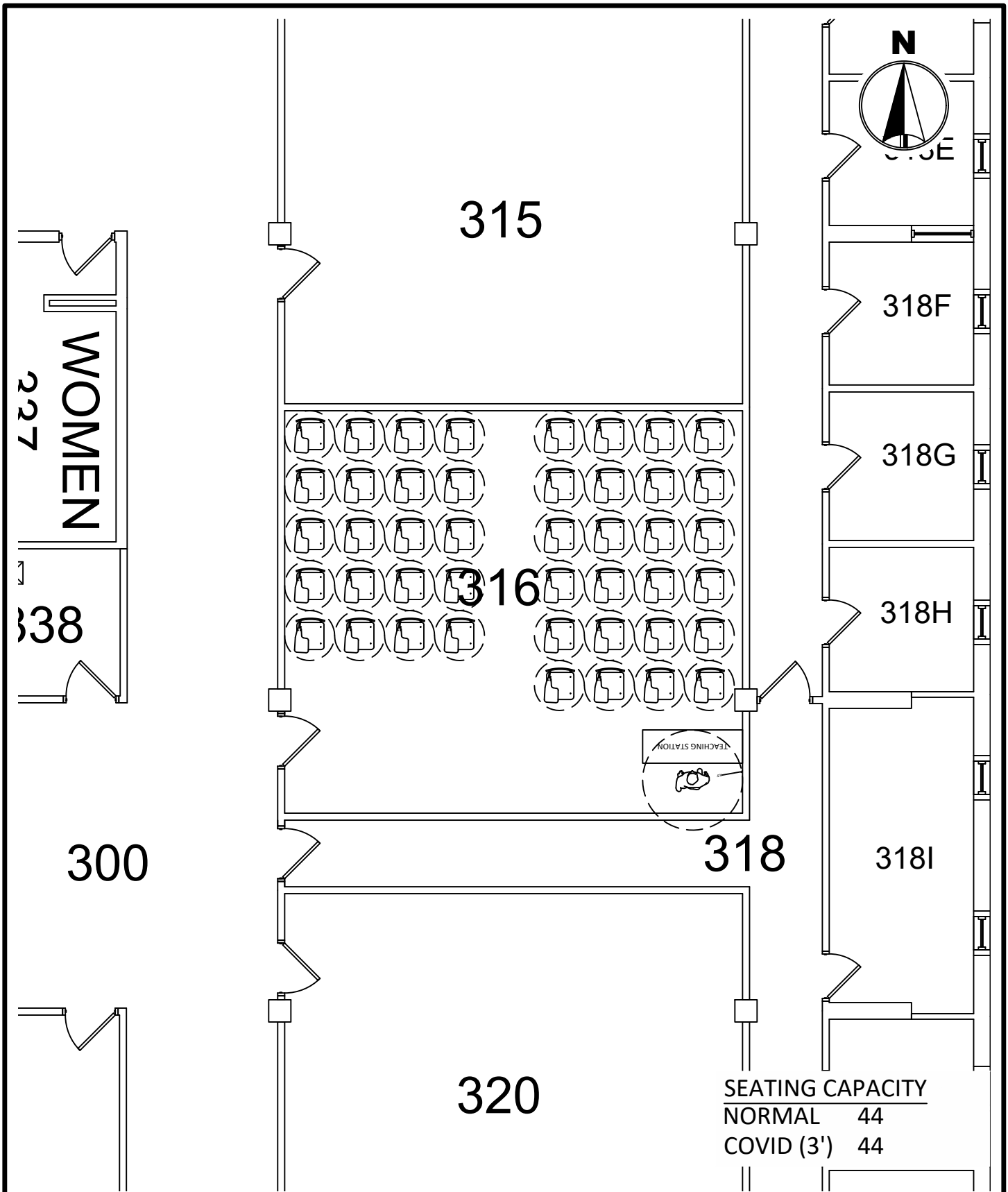

SEATING CAPACITY	
NORMAL	44
COVID (3')	44



**MINNESOTA STATE UNIVERSITY**  
MANKATO  
PLANNING & CONSTRUCTION

**ARMSTRONG HALL 316**  
COVID SEATING LAYOUT  
3' SOCIAL DISTANCE

DRAWN BY: N. HUETTL March 2021

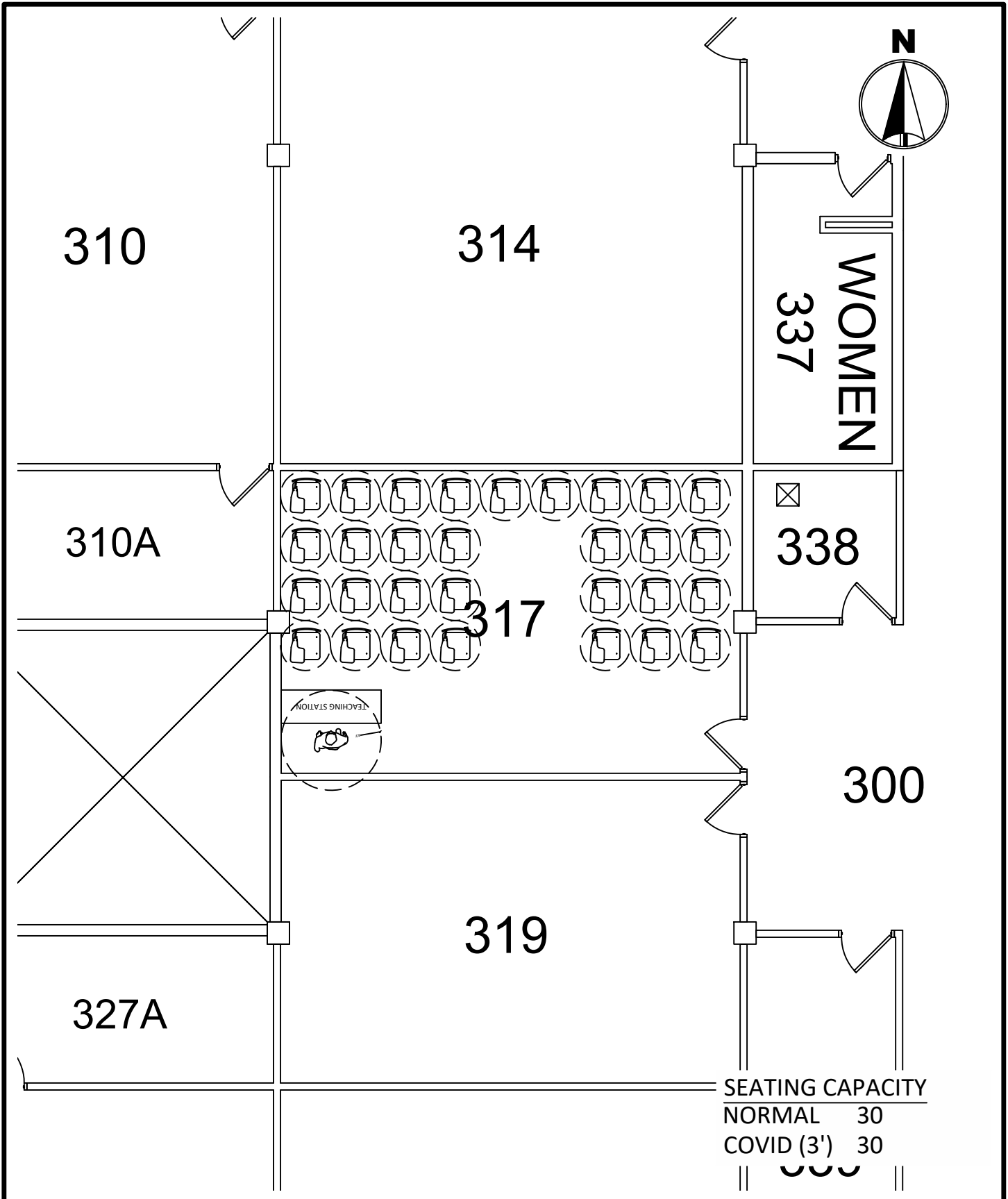

MINNESOTA STATE  
 UNIVERSITY  
 MANKATO  
 PLANNING & CONSTRUCTION

ARMSTRONG HALL 317  
 COVID SEATING LAYOUT  
 3' SOCIAL DISTANCE

DRAWN BY: N. HUETTL

March 2021



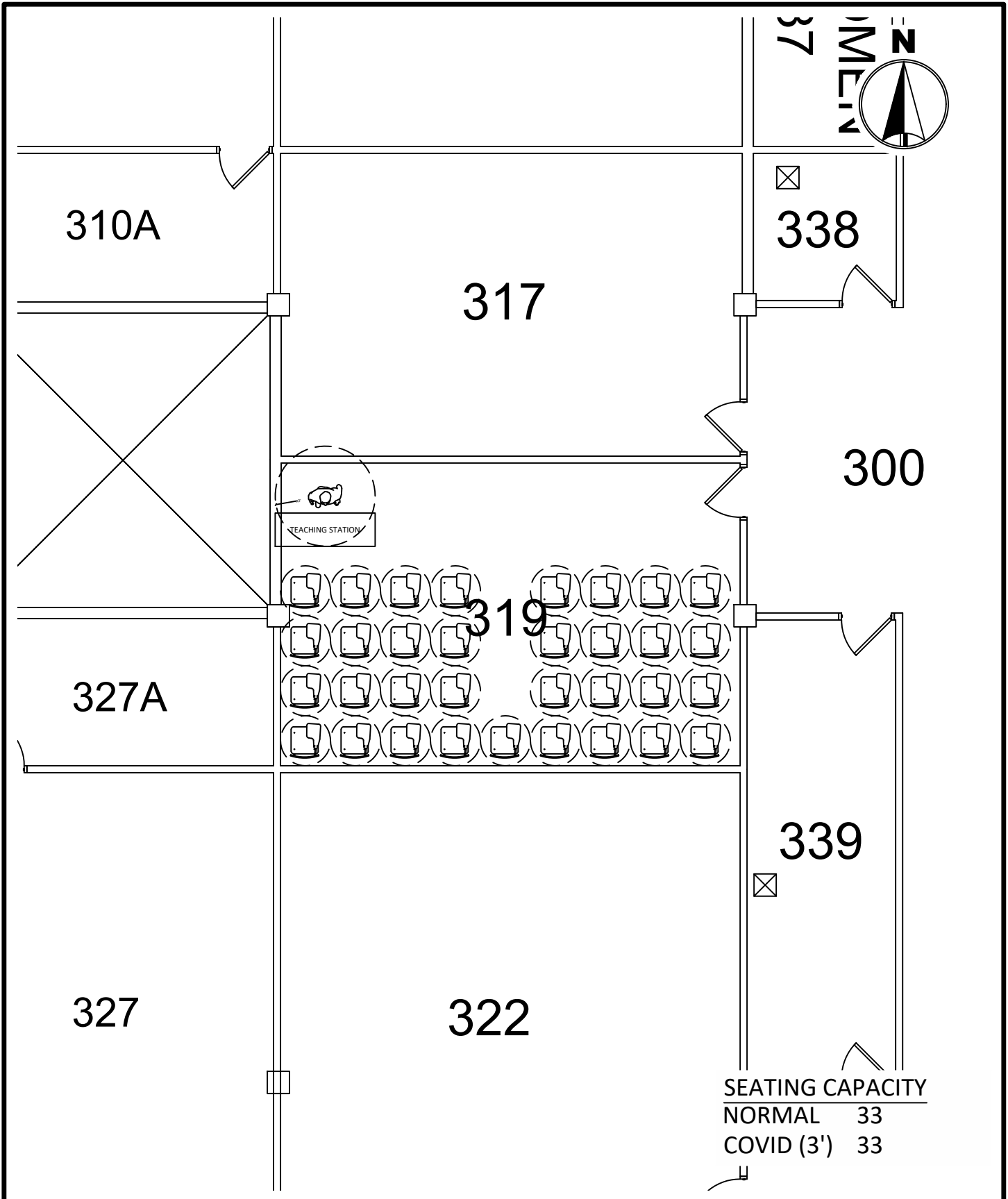

MINNESOTA STATE  
 UNIVERSITY  
 MANKATO  
 PLANNING & CONSTRUCTION

ARMSTRONG HALL 319  
 COVID SEATING LAYOUT  
 3' SOCIAL DISTANCE

DRAWN BY: N. HUETTL

March 2021

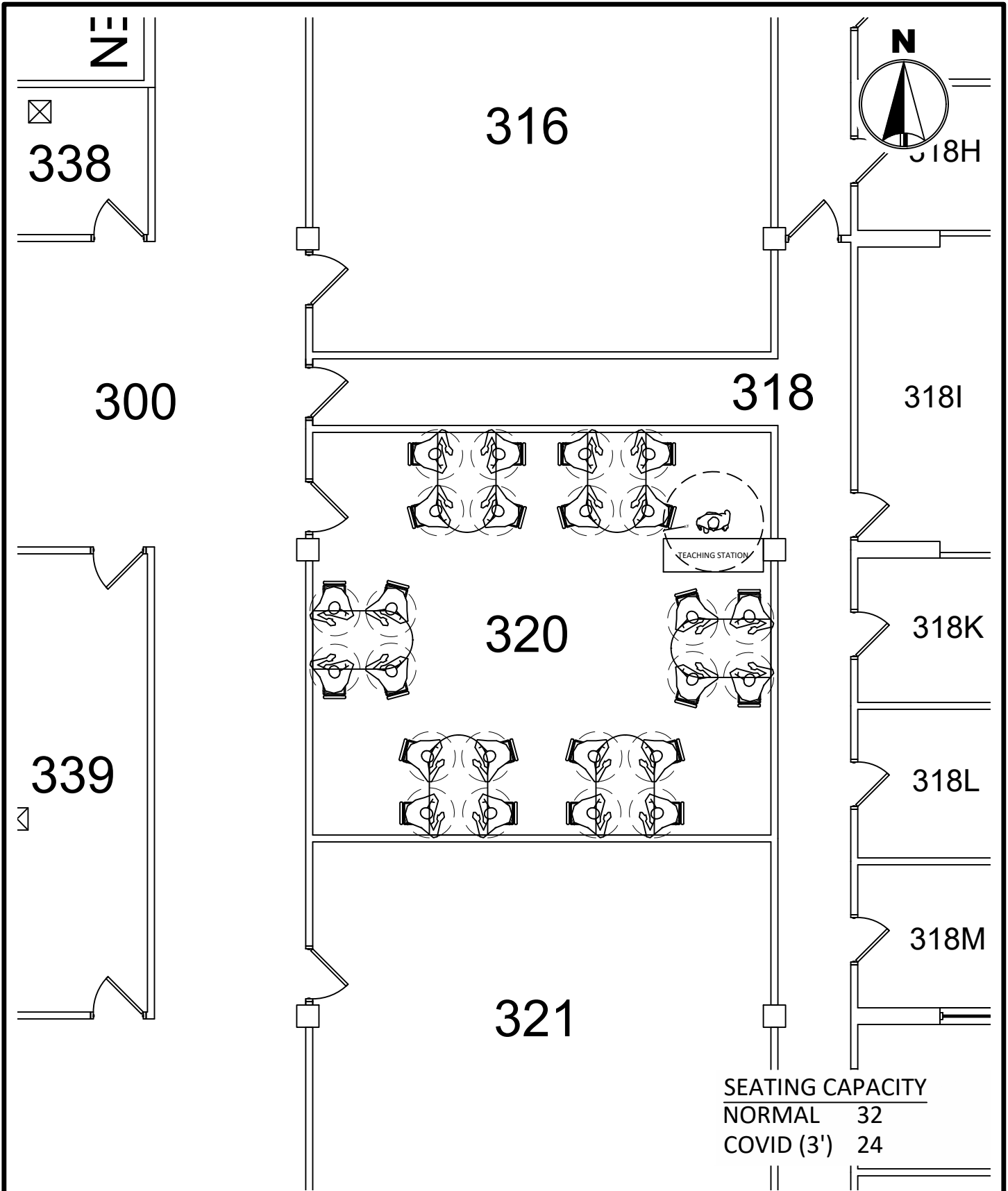

MINNESOTA STATE  
UNIVERSITY  
MANKATO  
PLANNING & CONSTRUCTION

ARMSTRONG HALL 320  
COVID SEATING LAYOUT  
3' SOCIAL DISTANCE

DRAWN BY: N. HUETTL

March 2021

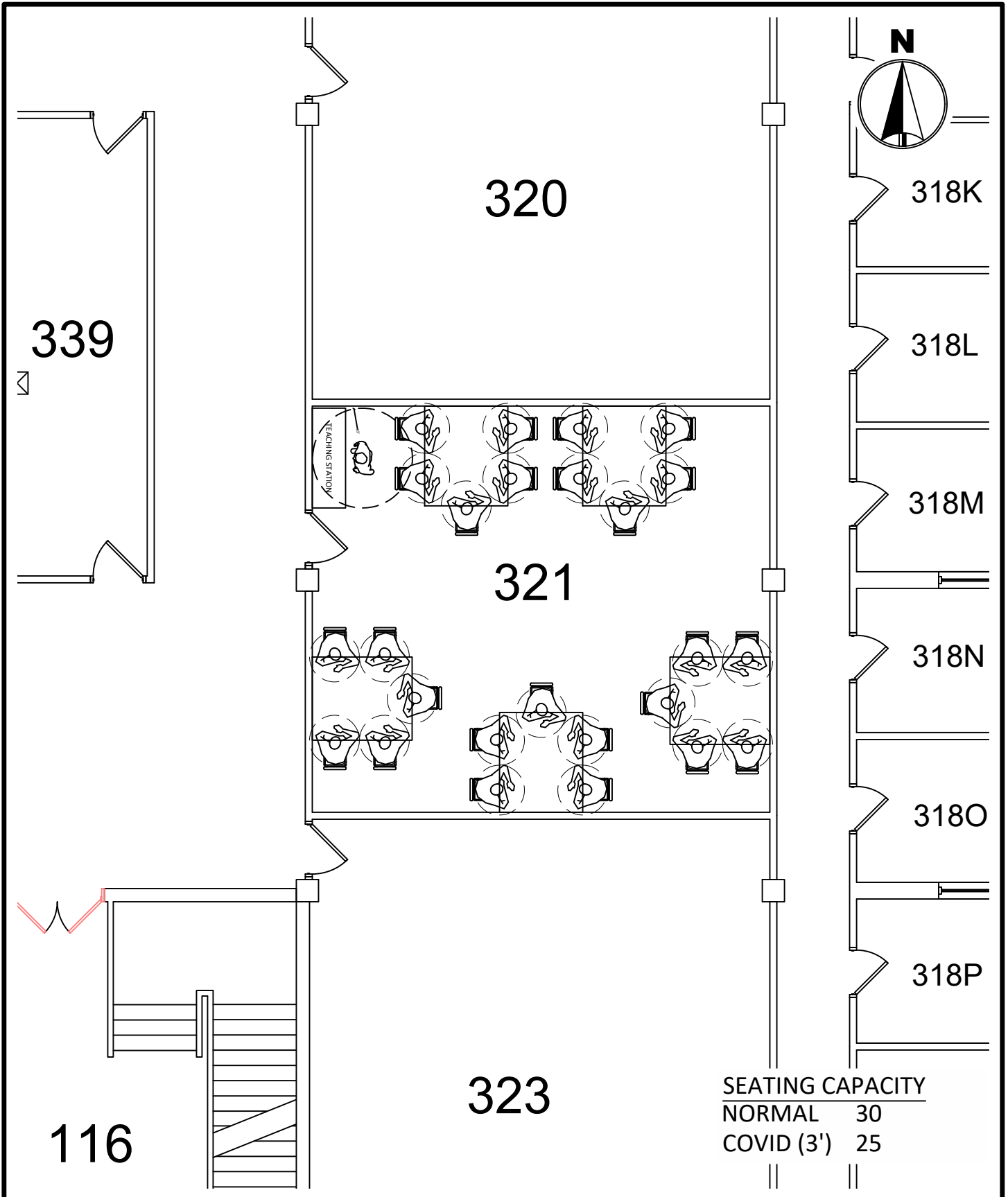

**MINNESOTA STATE UNIVERSITY**  
MANKATO  
**PLANNING & CONSTRUCTION**

**ARMSTRONG HALL 321**  
COVID SEATING LAYOUT  
3' SOCIAL DISTANCE

DRAWN BY: N. HUETTL

March 2021

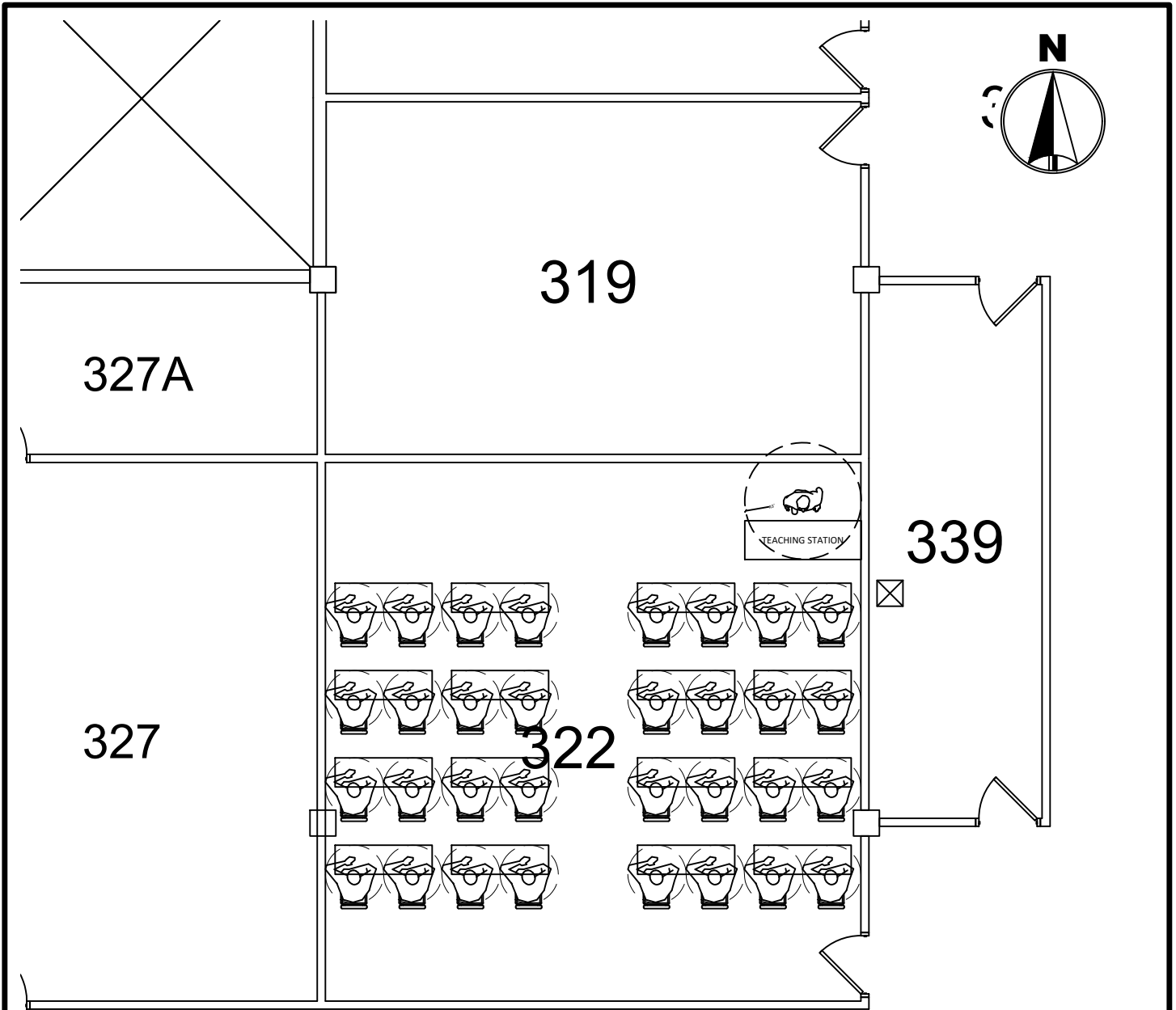

SEATING CAPACITY	
NORMAL	35
COVID (3')	32



**MINNESOTA STATE UNIVERSITY**  
MANKATO  
**PLANNING & CONSTRUCTION**

**ARMSTRONG HALL 322**  
COVID SEATING LAYOUT  
3' SOCIAL DISTANCE

DRAWN BY: N. HUETTL

March 2021

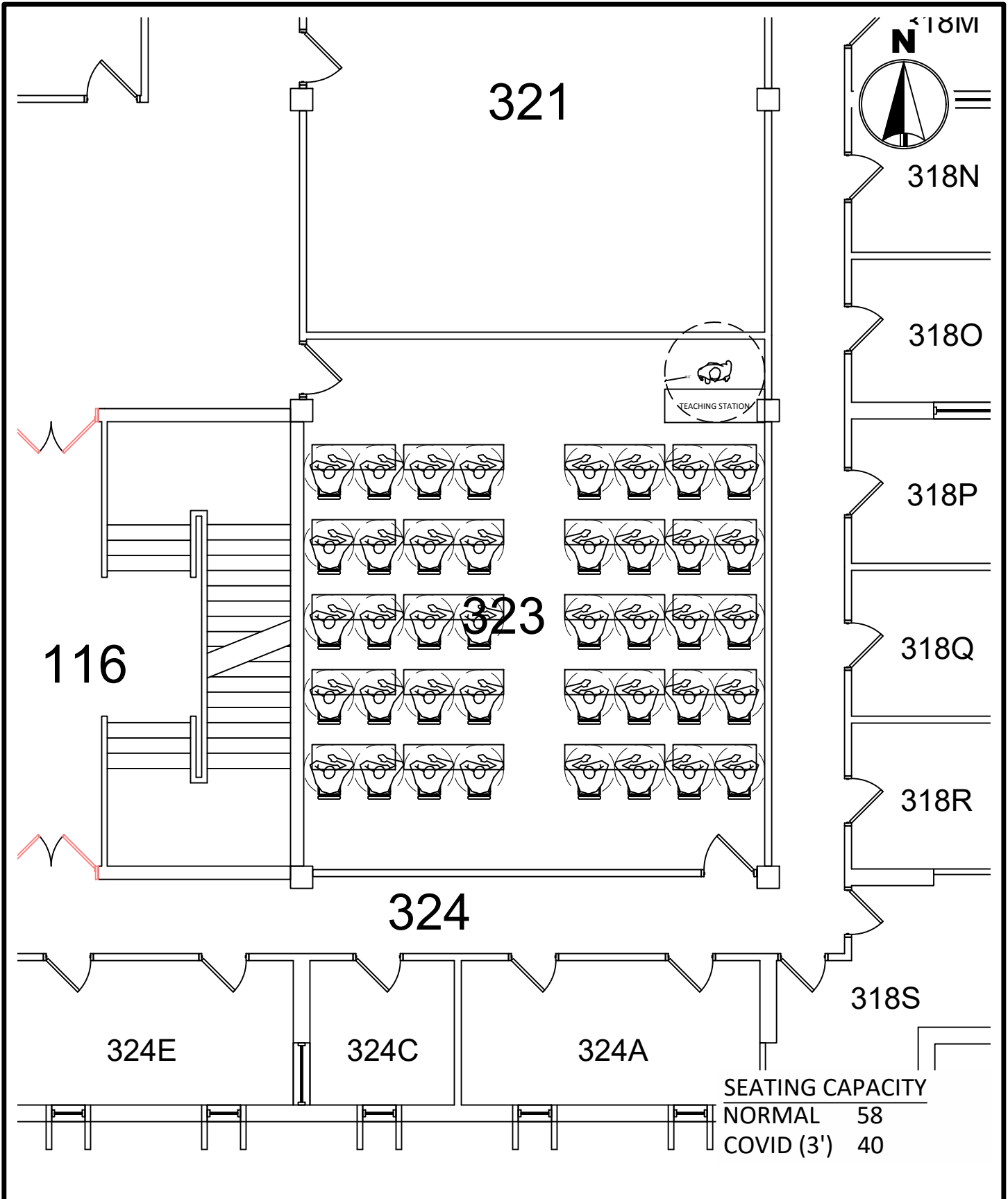

MINNESOTA STATE  
UNIVERSITY  
MANKATO  
PLANNING & CONSTRUCTION

ARMSTRONG HALL 323  
COVID SEATING LAYOUT  
3' SOCIAL DISTANCE

DRAWN BY: N. HUETTL

March 2021

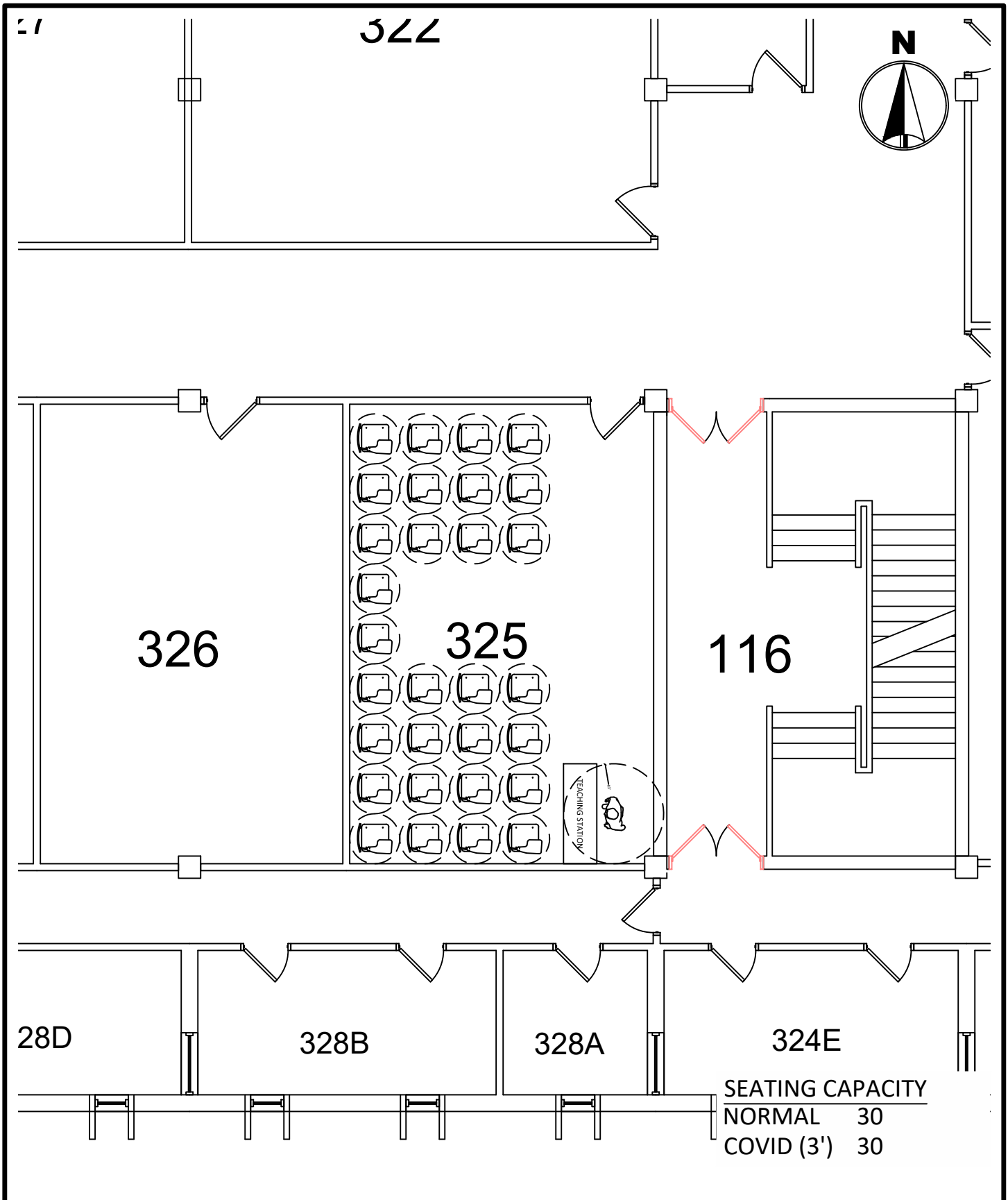

MINNESOTA STATE  
UNIVERSITY  
MANKATO  
PLANNING & CONSTRUCTION

ARMSTRONG HALL 325  
COVID SEATING LAYOUT  
3' SOCIAL DISTANCE

DRAWN BY: N. HUETTL March 2021

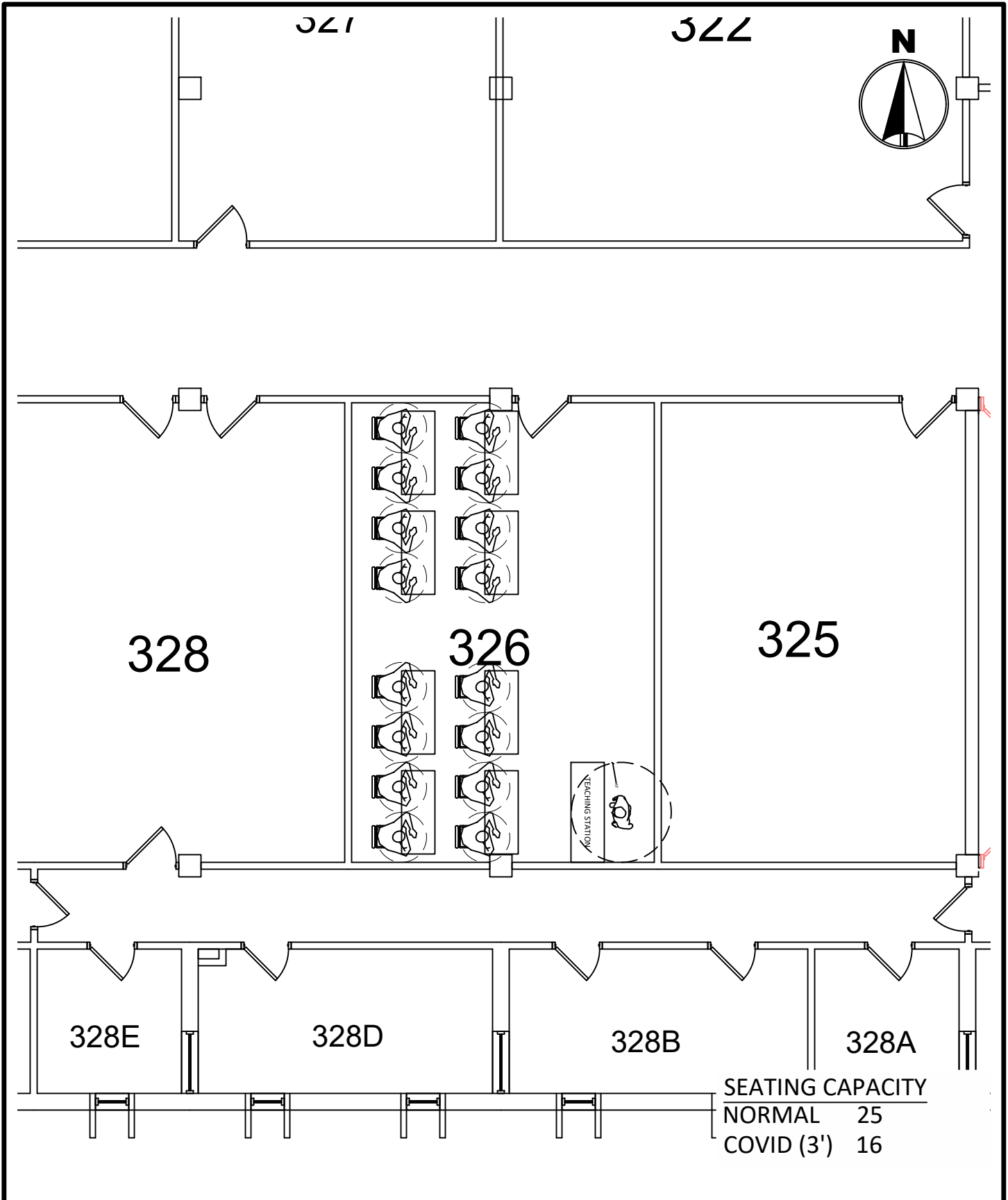

MINNESOTA STATE  
UNIVERSITY  
MANKATO  
PLANNING & CONSTRUCTION

ARMSTRONG HALL 326  
COVID SEATING LAYOUT  
3' SOCIAL DISTANCE

DRAWN BY: N. HUETTL

March 2021

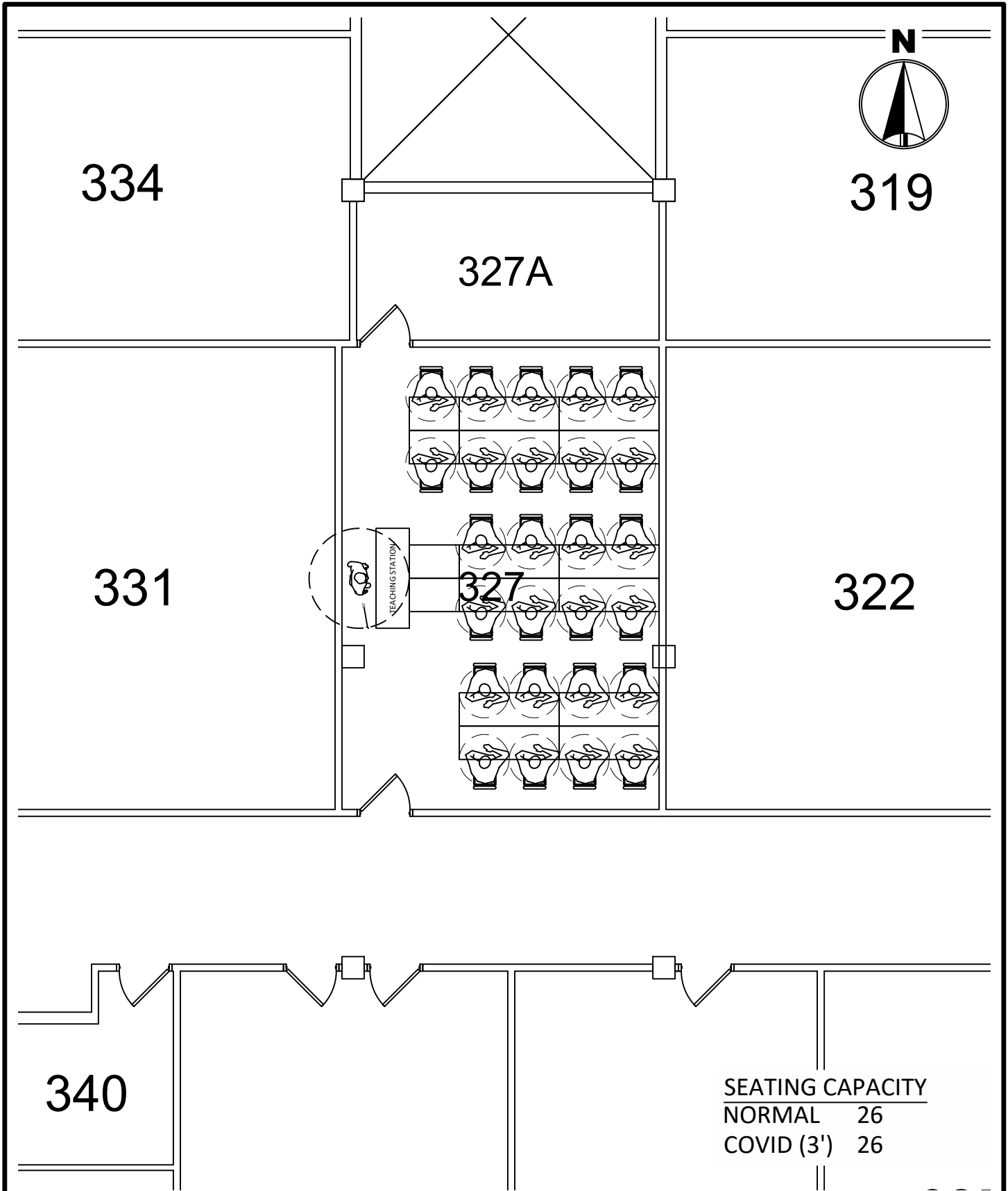

MINNESOTA STATE UNIVERSITY  
 MANKATO  
 PLANNING & CONSTRUCTION

ARMSTRONG HALL 327  
 COVID SEATING LAYOUT  
 3' SOCIAL DISTANCE  
 DRAWN BY: N. HUETTL March 2021



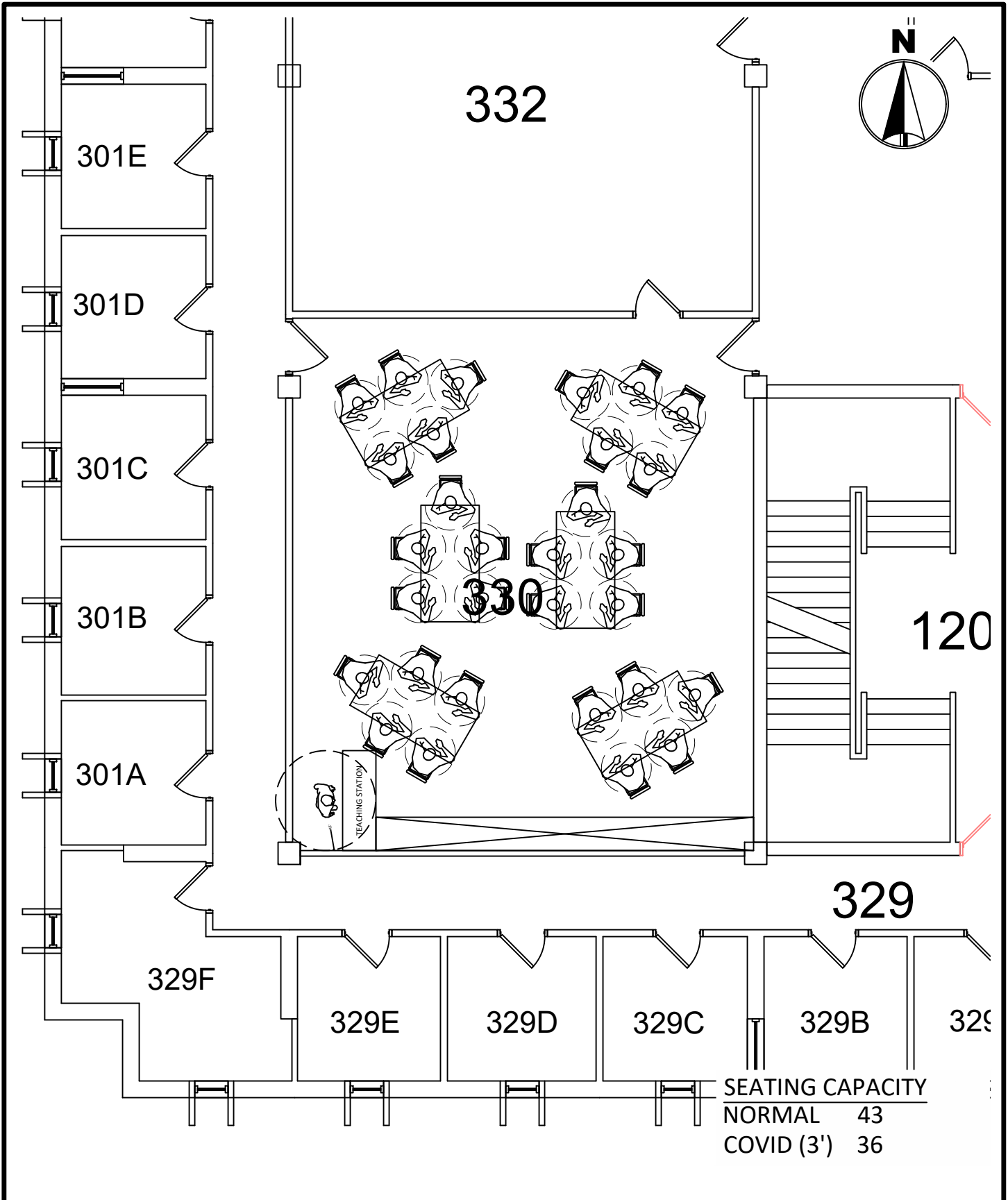

MINNESOTA STATE  
UNIVERSITY  
MANKATO  
PLANNING & CONSTRUCTION

ARMSTRONG HALL 330  
COVID SEATING LAYOUT  
3' SOCIAL DISTANCE

DRAWN BY: N. HUETTL

March 2021

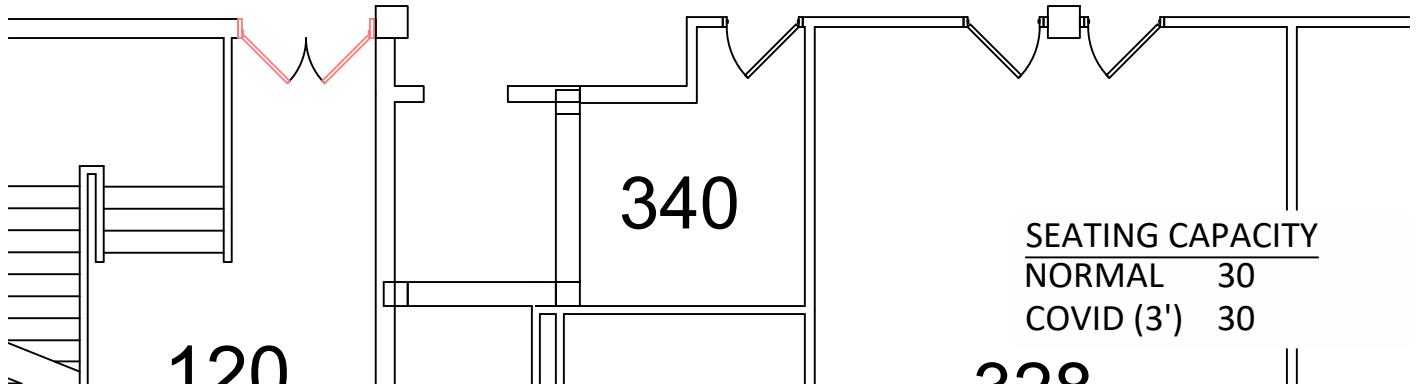
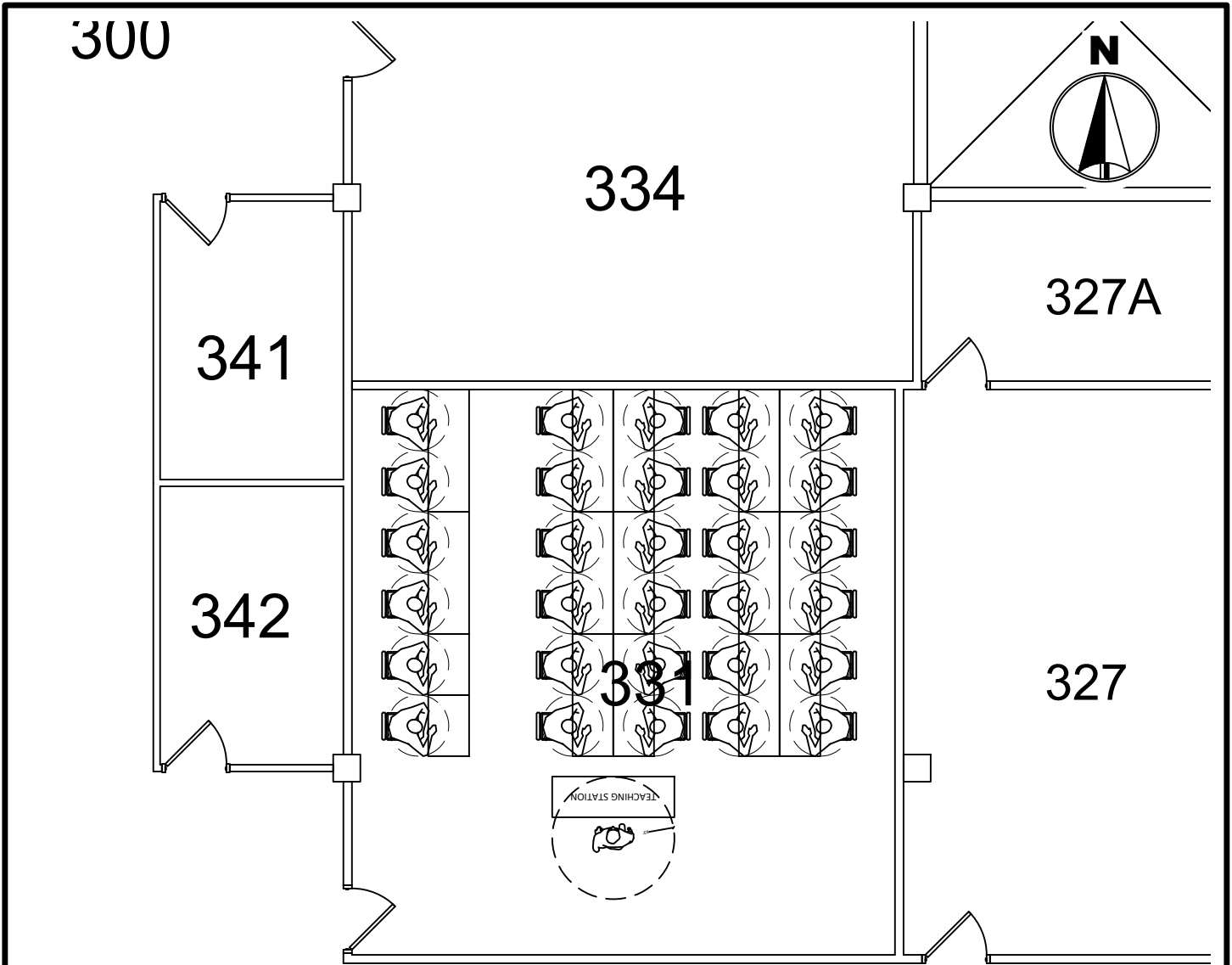

SEATING CAPACITY  
 NORMAL 30  
 COVID (3') 30



MINNESOTA STATE  
 UNIVERSITY  
 MANKATO  
 PLANNING & CONSTRUCTION

ARMSTRONG HALL 331  
 COVID SEATING LAYOUT  
 3' SOCIAL DISTANCE

DRAWN BY: N. HUETTL

March 2021

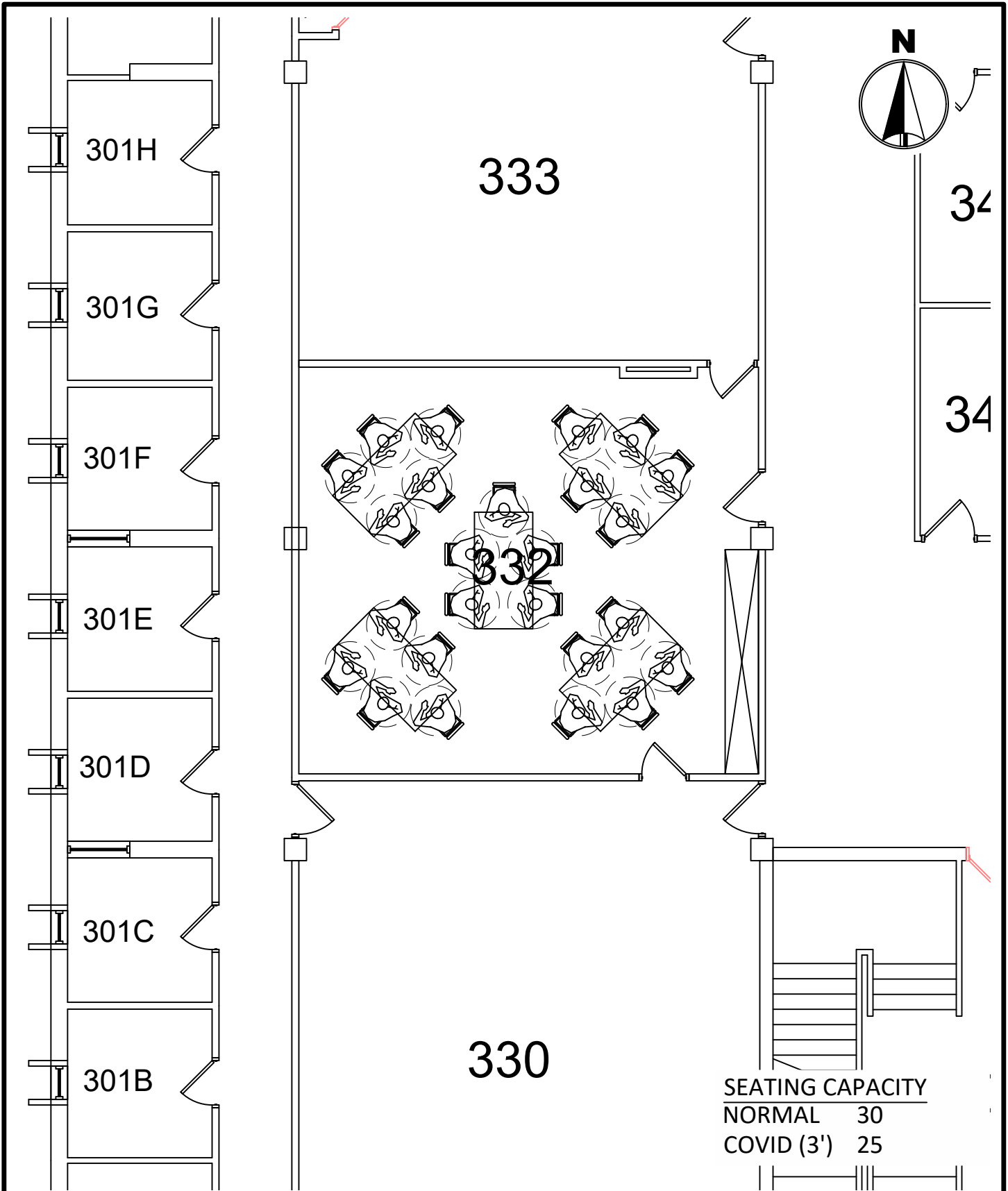

MINNESOTA STATE  
UNIVERSITY  
MANKATO  
PLANNING & CONSTRUCTION

ARMSTRONG HALL 332  
COVID SEATING LAYOUT  
3' SOCIAL DISTANCE

DRAWN BY: N. HUETTL

March 2021

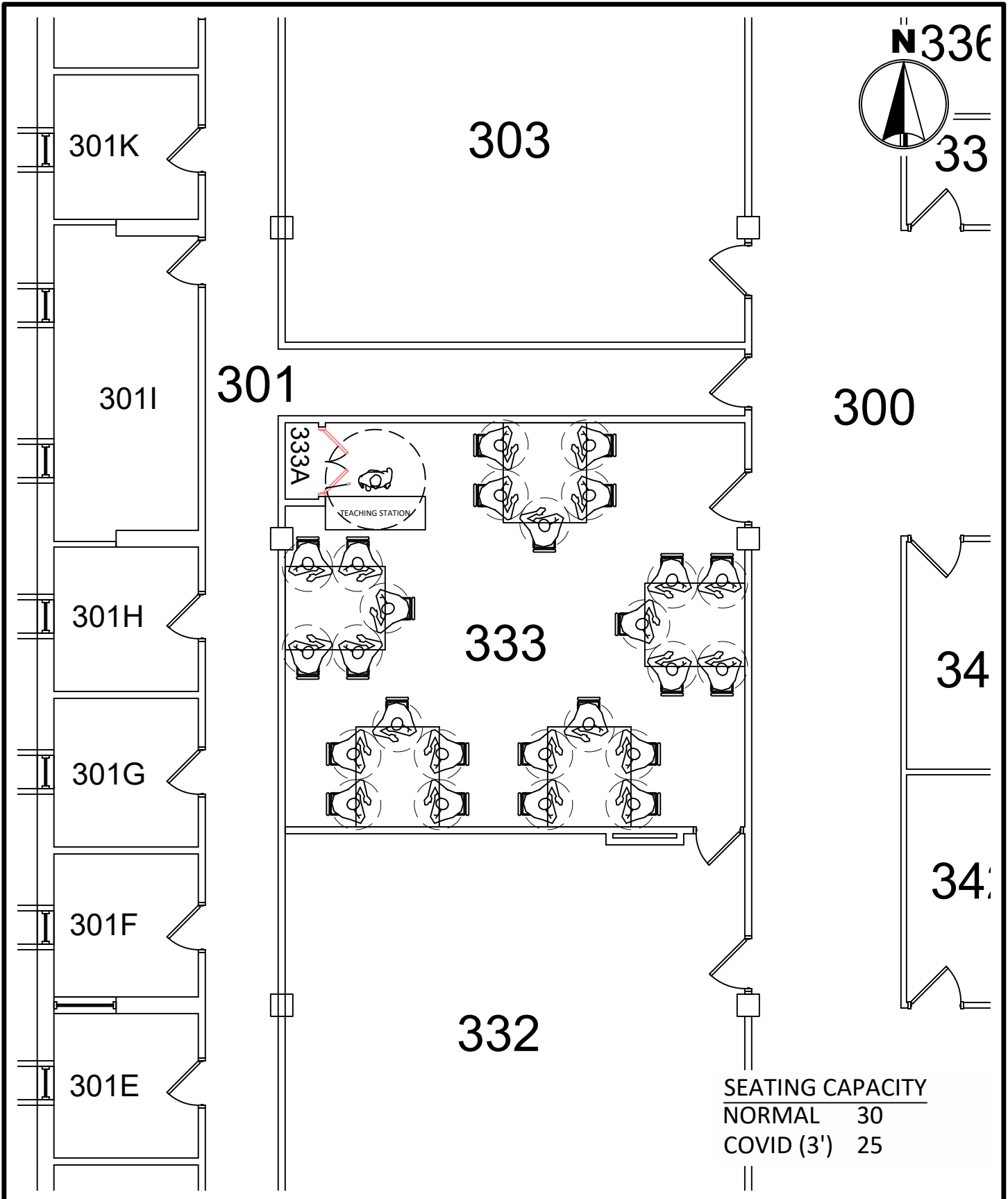

MINNESOTA STATE  
UNIVERSITY  
MANKATO

PLANNING & CONSTRUCTION

ARMSTRONG HALL 333  
COVID SEATING LAYOUT  
3' SOCIAL DISTANCE

DRAWN BY: N. HUETTL

March 2021

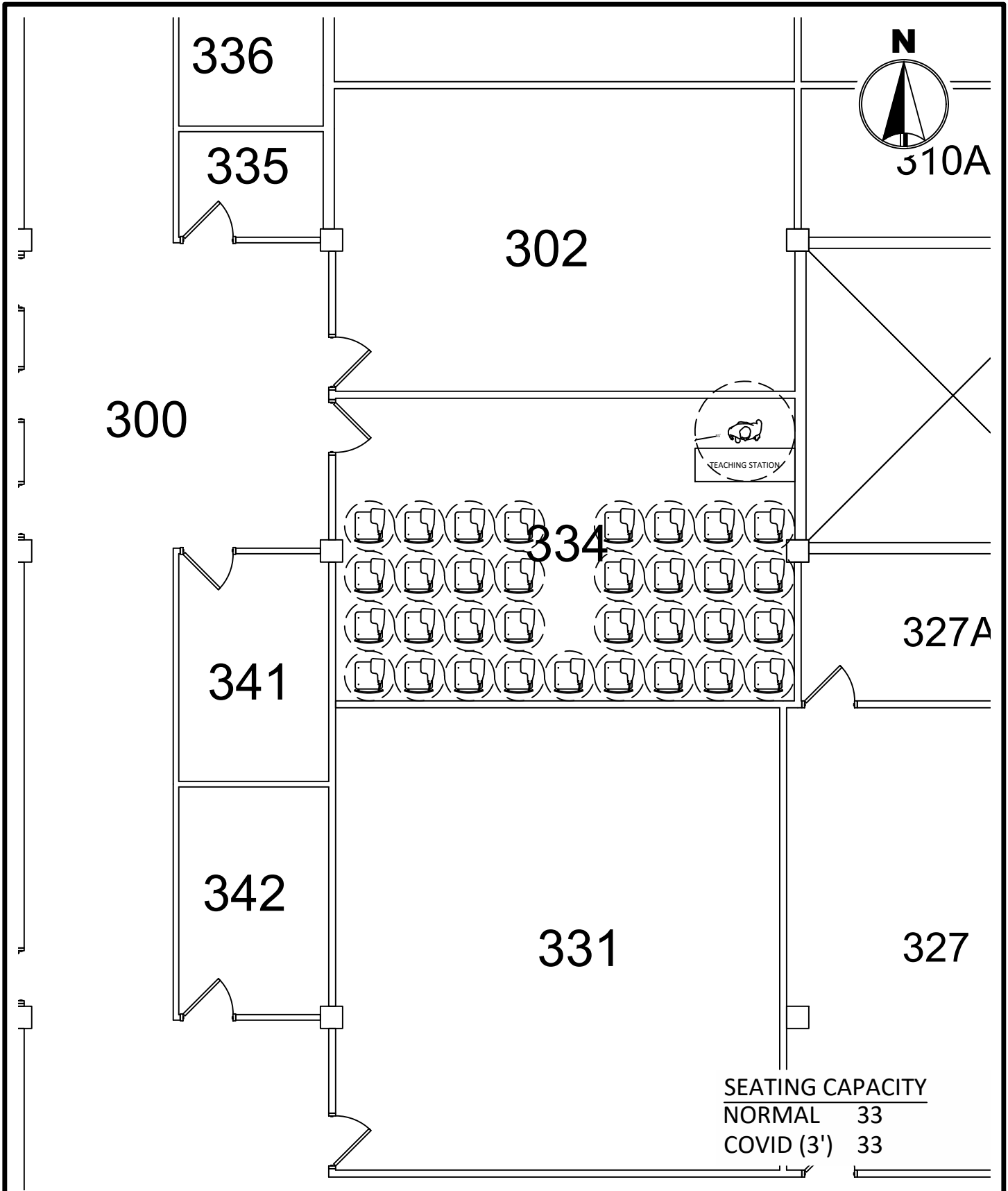

MINNESOTA STATE  
 UNIVERSITY  
 MANKATO  
 PLANNING & CONSTRUCTION

ARMSTRONG HALL 334  
 COVID SEATING LAYOUT  
 3' SOCIAL DISTANCE

DRAWN BY: N. HUETTL

March 2021

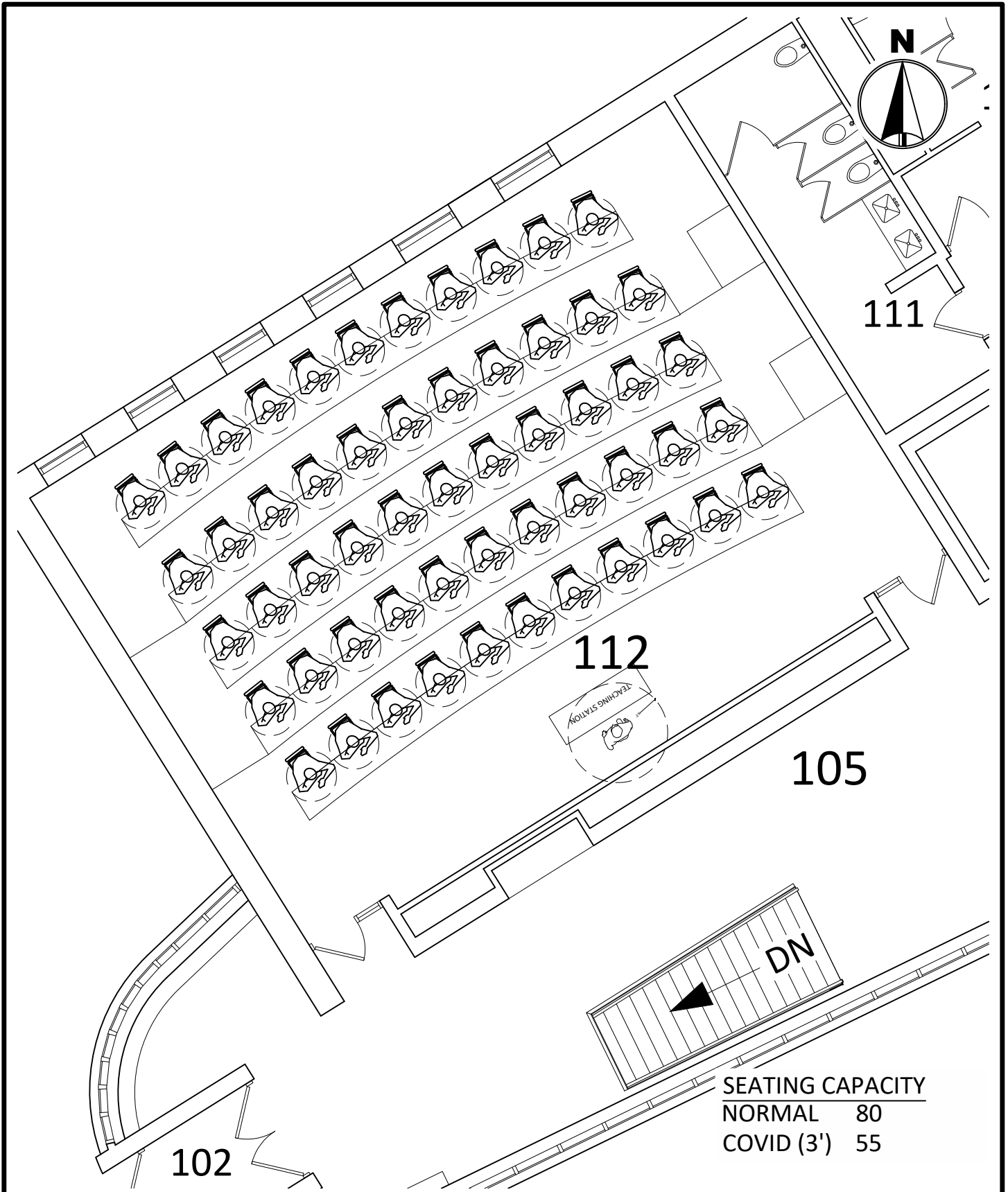

SEATING CAPACITY  
 NORMAL 80  
 COVID (3') 55



MINNESOTA STATE  
 UNIVERSITY  
 MANKATO  
 PLANNING & CONSTRUCTION

CLINICAL SCIENCES BUILDING 112  
 COVID SEATING LAYOUT  
 3' SOCIAL DISTANCE

DRAWN BY: N. HUETTL

March 2021

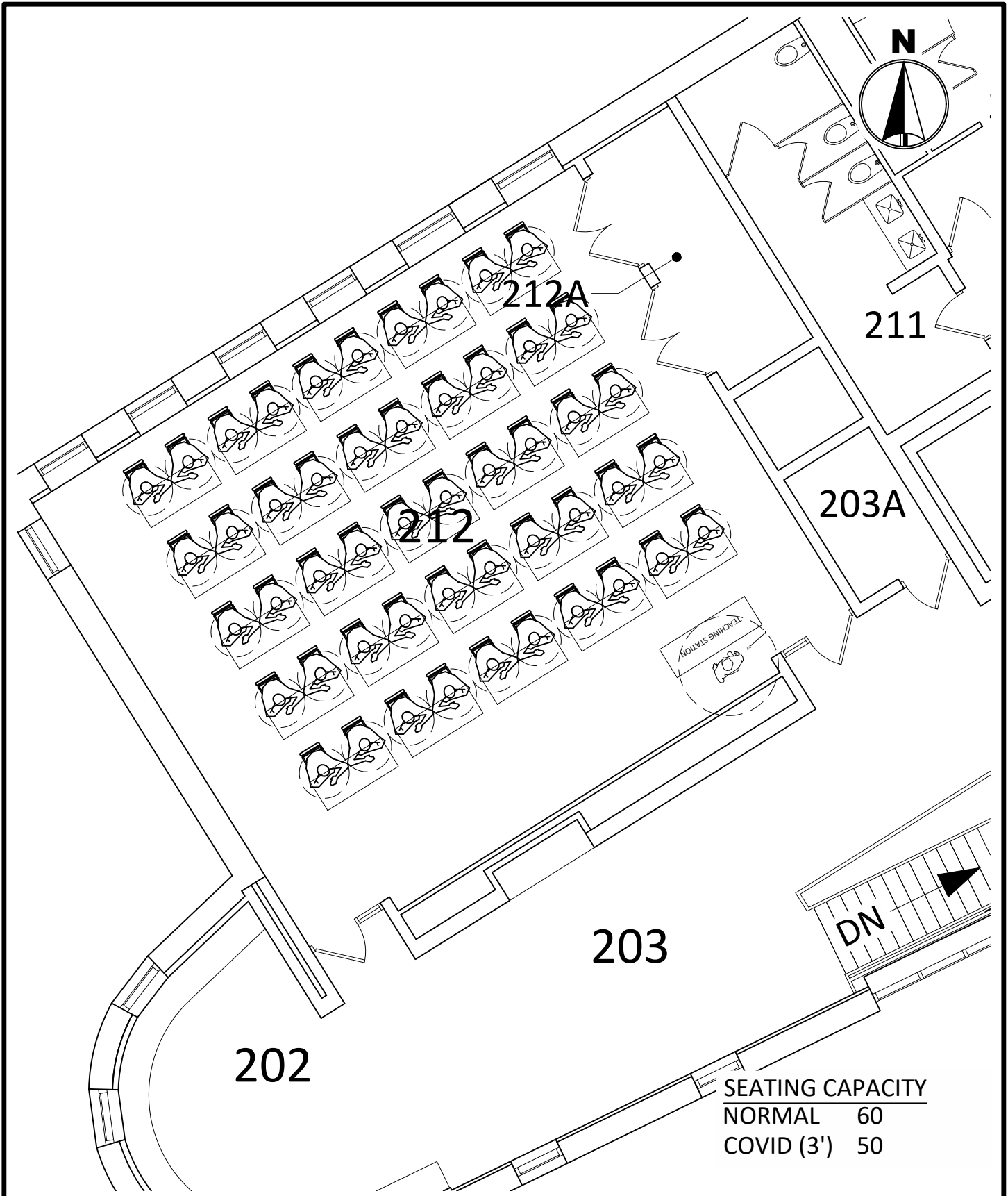

SEATING CAPACITY  
 NORMAL 60  
 COVID (3') 50



MINNESOTA STATE  
 UNIVERSITY  
 MANKATO  
 PLANNING & CONSTRUCTION

CLINICAL SCIENCES BUILDING 212  
 COVID SEATING LAYOUT  
 3' SOCIAL DISTANCE

DRAWN BY: N. HUETTL March 2021

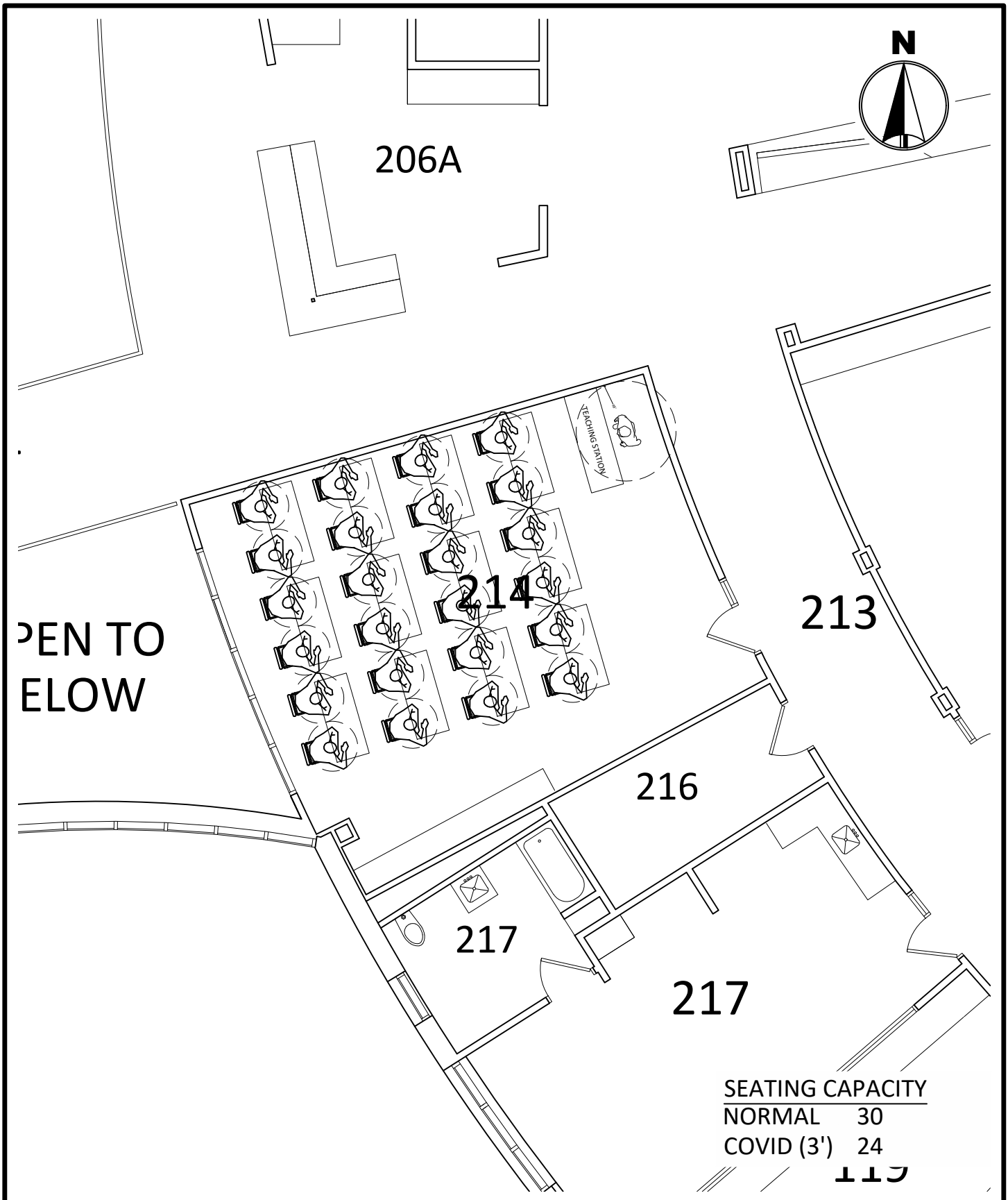

MINNESOTA STATE UNIVERSITY  
MANKATO  
PLANNING & CONSTRUCTION

CLINICAL SCIENCES BUILDING 214  
COVID SEATING LAYOUT  
3' SOCIAL DISTANCE

DRAWN BY: N. HUETTL March 2021



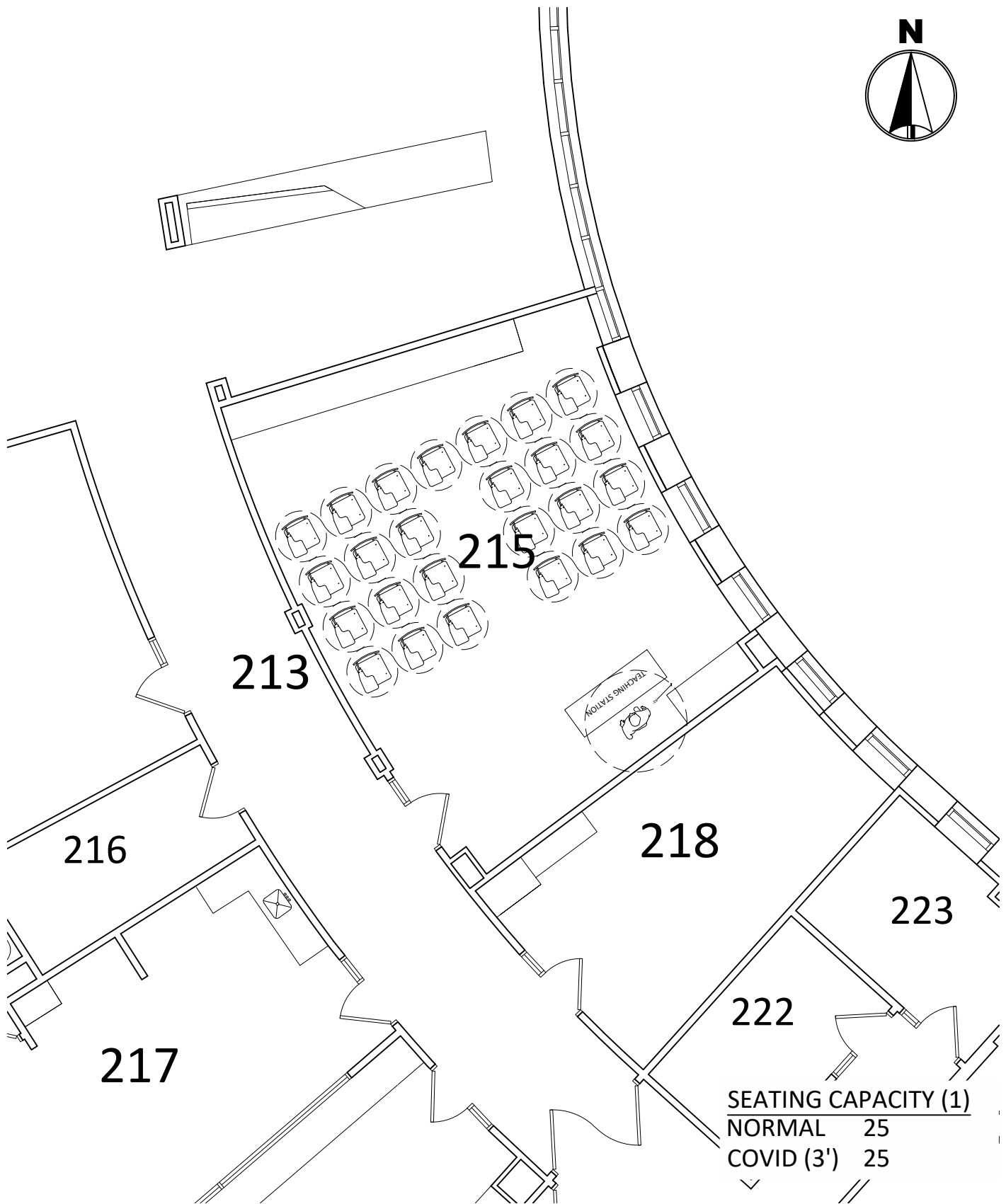
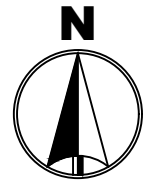

SEATING CAPACITY (1)	
NORMAL	25
COVID (3')	25



**MINNESOTA STATE UNIVERSITY**  
MANKATO  
PLANNING & CONSTRUCTION

**CLINICAL SCIENCES BUILDING 215**  
COVID SEATING LAYOUT  
3' SOCIAL DISTANCE

DRAWN BY: N. HUETTL

March 2021

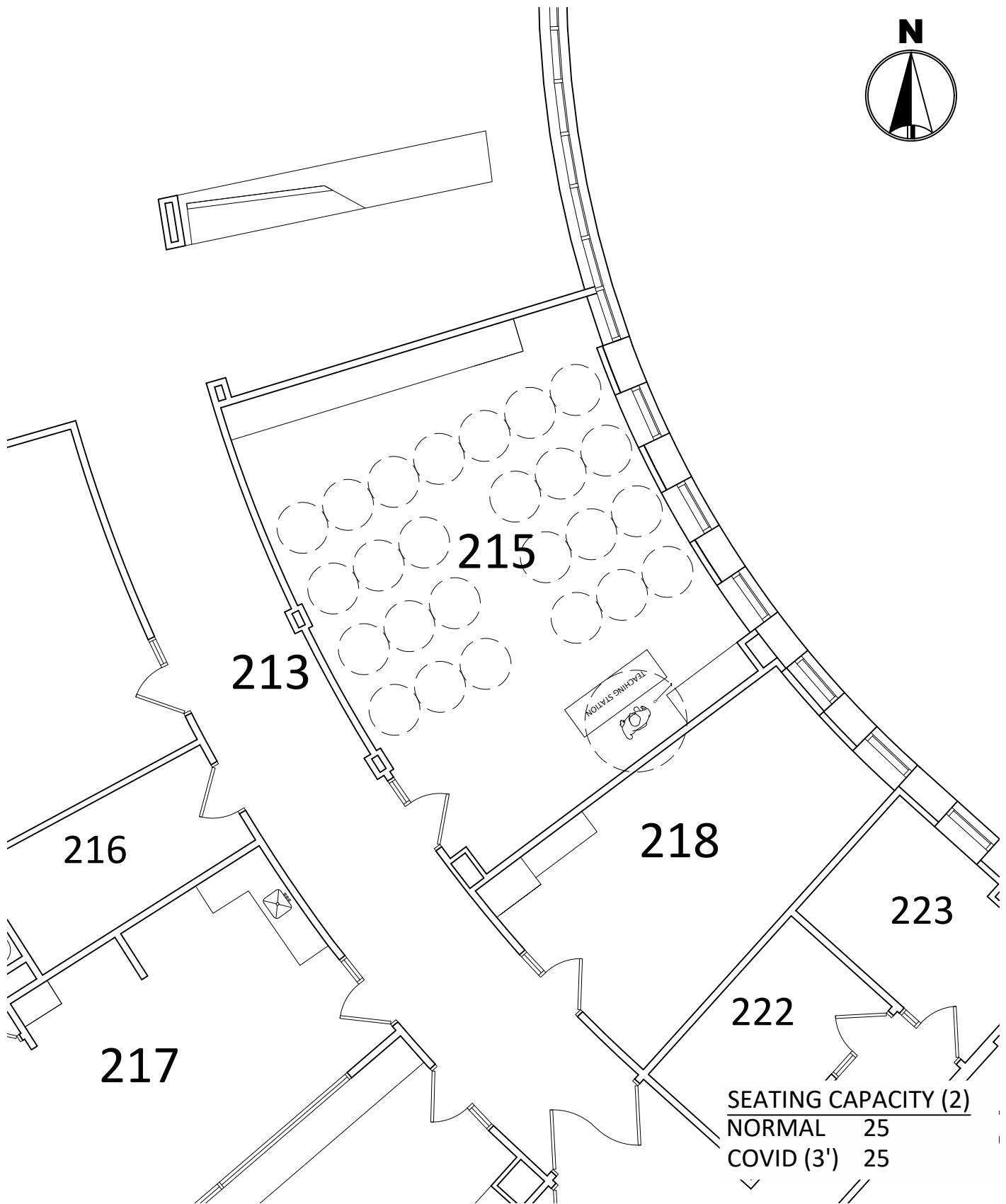

SEATING CAPACITY (2)	
NORMAL	25
COVID (3')	25



**MINNESOTA STATE UNIVERSITY**  
MANKATO  
PLANNING & CONSTRUCTION

**CLINICAL SCIENCES BUILDING 215**  
COVID SEATING LAYOUT  
3' SOCIAL DISTANCE

DRAWN BY: N. HUETTL March 2021

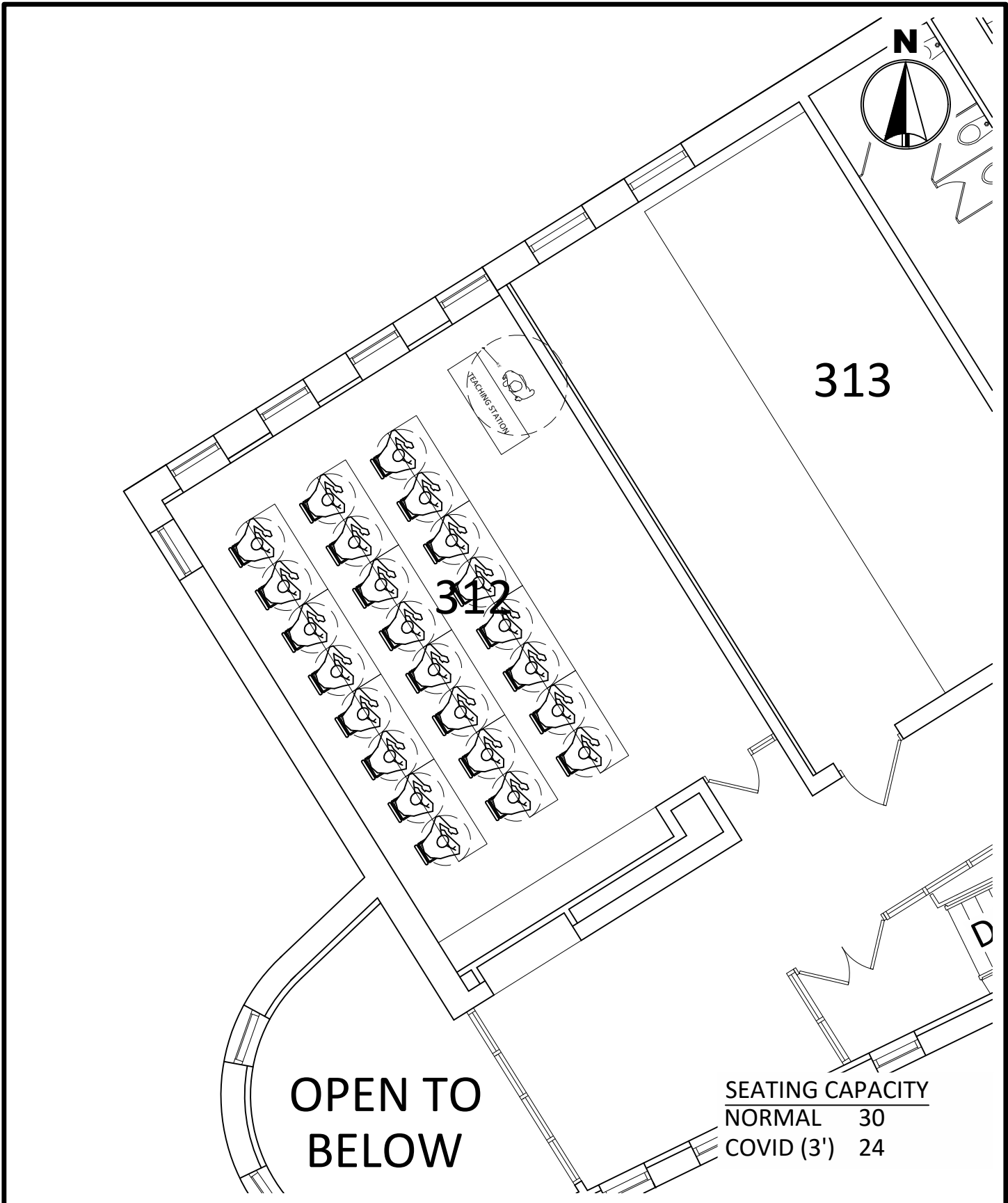

**MINNESOTA STATE UNIVERSITY**  
 MANKATO  
 PLANNING & CONSTRUCTION

**CLINICAL SCIENCES BUILDING 312**  
 COVID SEATING LAYOUT  
 3' SOCIAL DISTANCE

DRAWN BY: N. HUETTL

March 2021

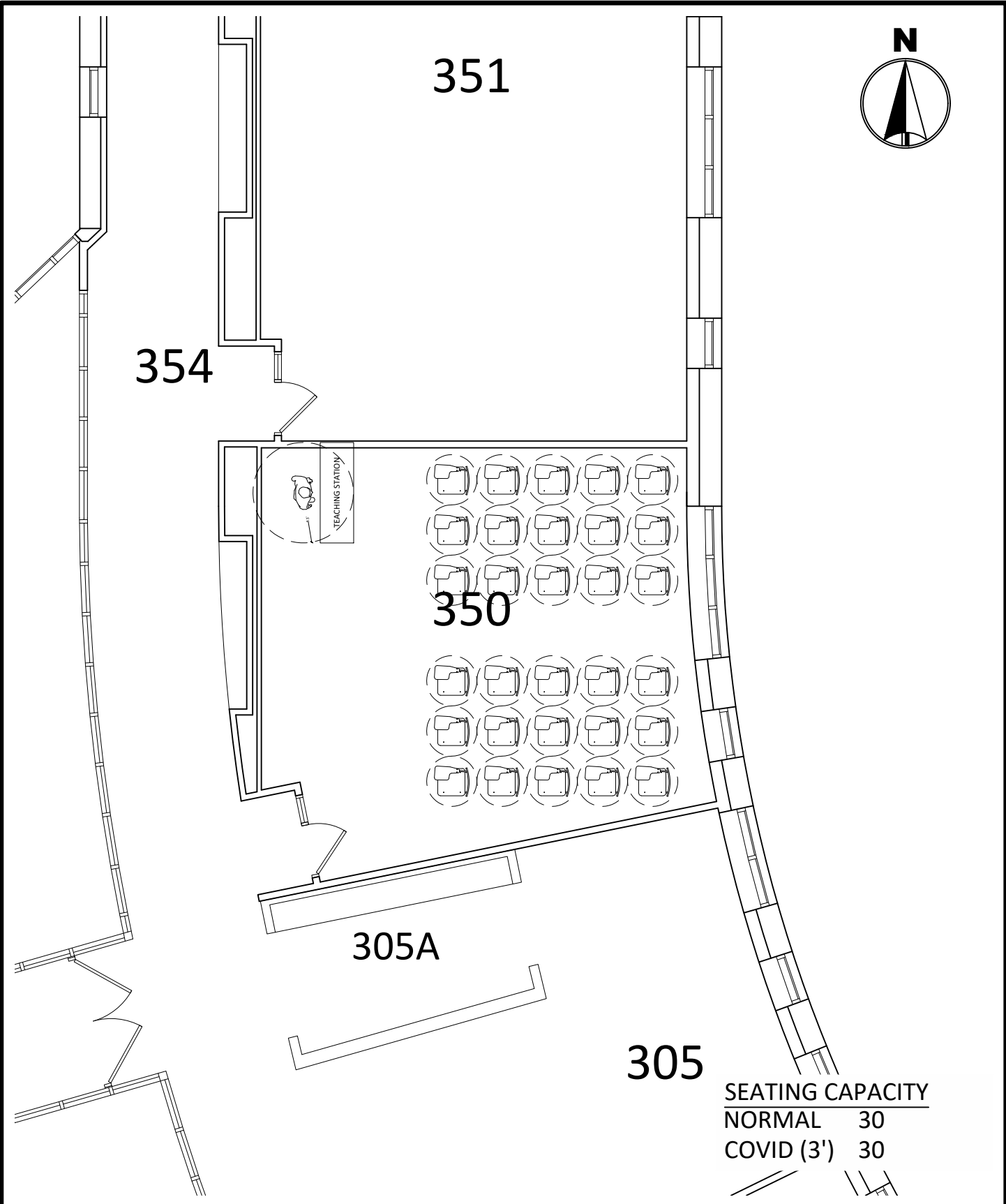

MINNESOTA STATE  
UNIVERSITY  
MANKATO  
PLANNING & CONSTRUCTION

CLINICAL SCIENCES BUILDING 350  
COVID SEATING LAYOUT  
3' SOCIAL DISTANCE

DRAWN BY: N. HUETTL

March 2021

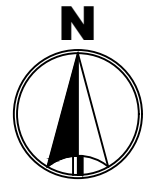

ROC

352

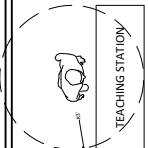
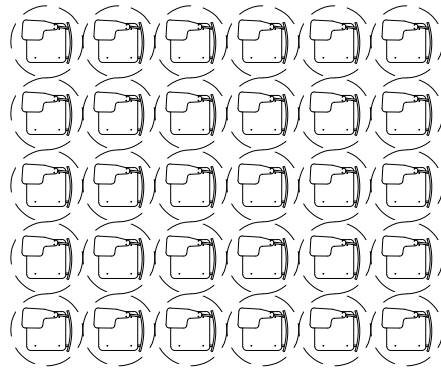
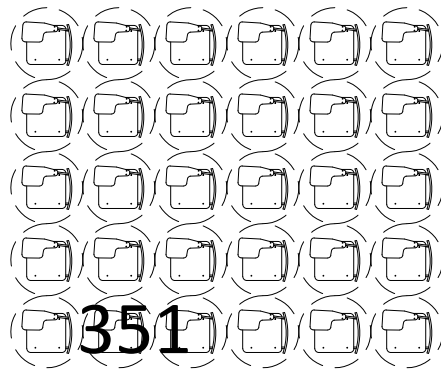
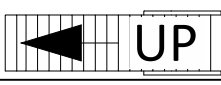

354

350

SEATING CAPACITY	
NORMAL	60
COVID (3')	60



O

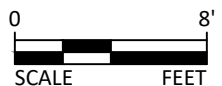

MINNESOTA STATE UNIVERSITY  
MANKATO  
PLANNING & CONSTRUCTION

CLINICAL SCIENCES BUILDING 351  
COVID SEATING LAYOUT  
3' SOCIAL DISTANCE

DRAWN BY: N. HUETTL

March 2021

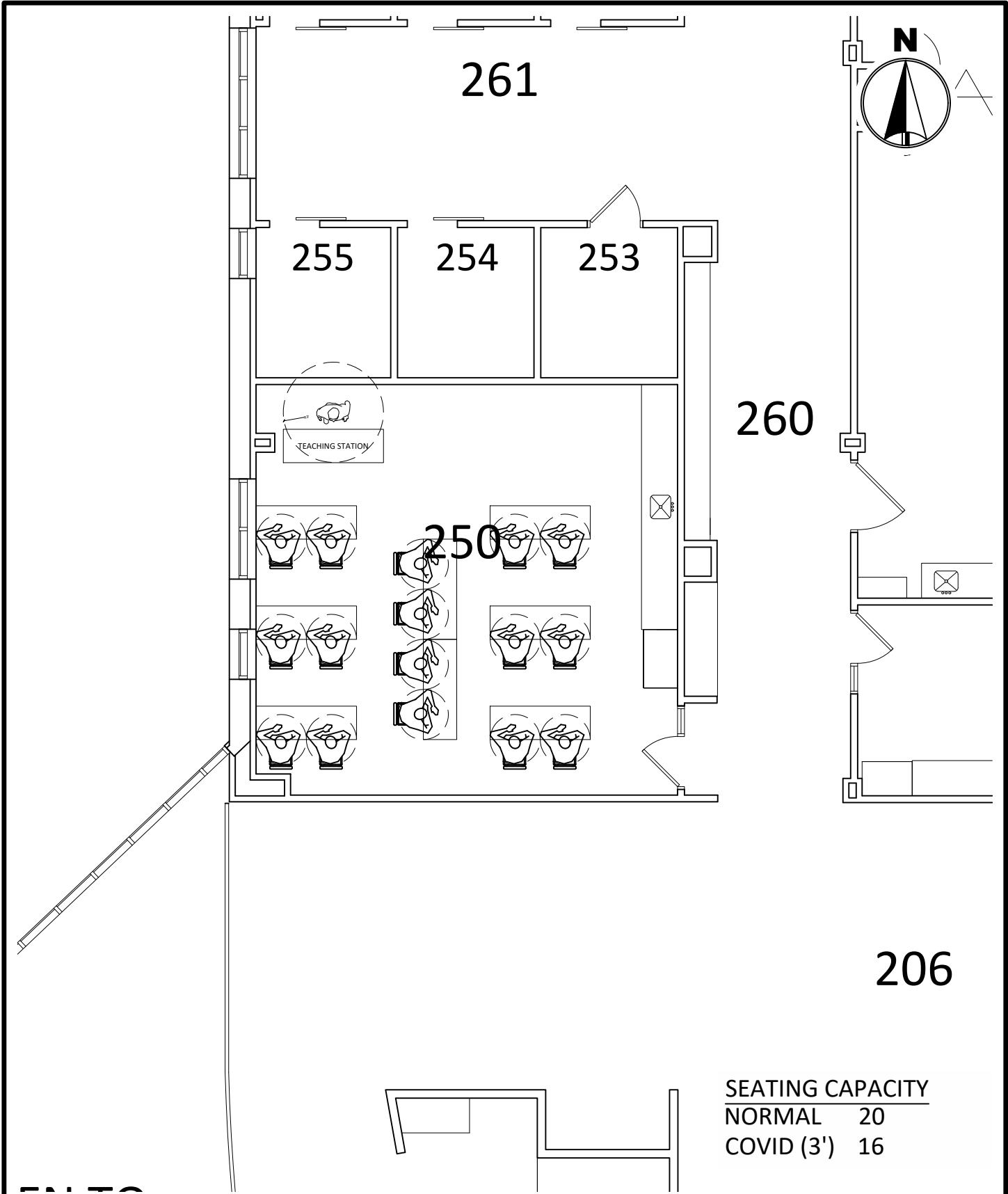

SEATING CAPACITY  
 NORMAL 20  
 COVID (3') 16



MINNESOTA STATE  
 UNIVERSITY  
 MANKATO  
 PLANNING & CONSTRUCTION

CLINICAL SCIENCES BUILDING 250  
 COVID SEATING LAYOUT  
 3' SOCIAL DISTANCE

DRAWN BY: N. HUETTL

March 2021

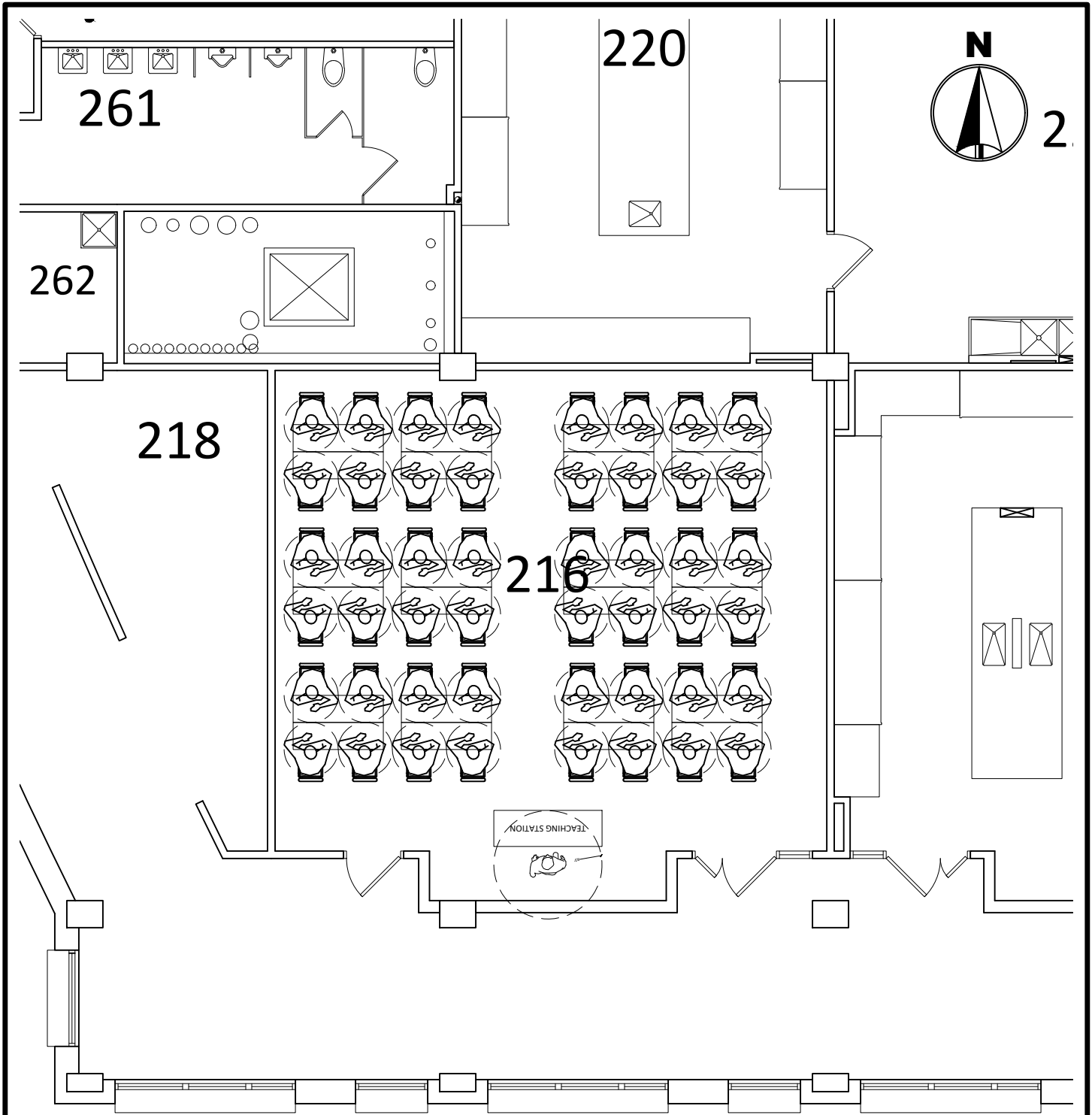

SEATING CAPACITY	
NORMAL	48
COVID	48



**MINNESOTA STATE UNIVERSITY**  
MANKATO  
PLANNING & CONSTRUCTION

**FORD HALL 216**  
COVID SEATING LAYOUT  
3' SOCIAL DISTANCE

DRAWN BY: N. HUETTL

March 2021

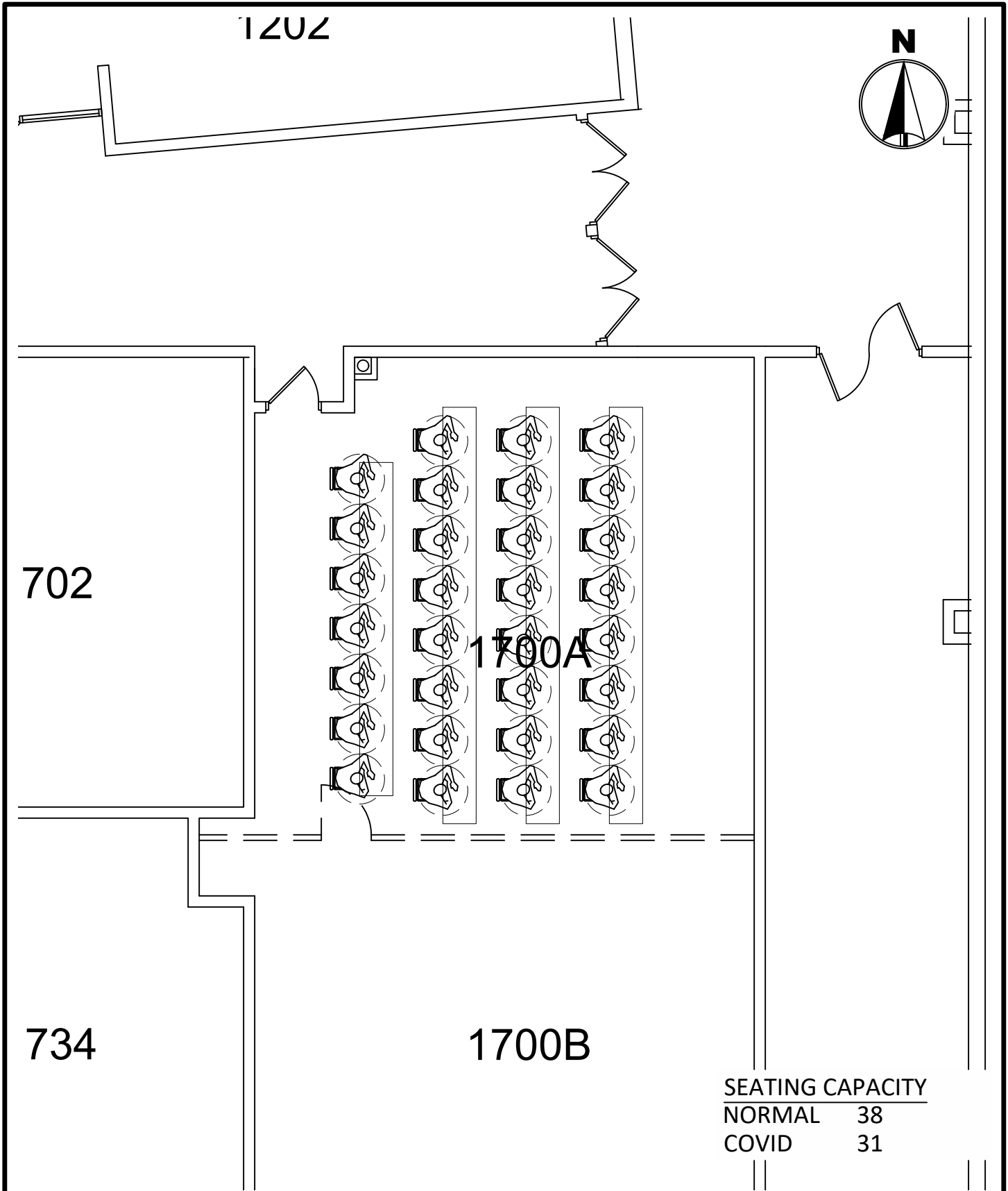

MINNESOTA STATE  
UNIVERSITY  
MANKATO  
PLANNING & CONSTRUCTION

HIGHLAND CENTER 1700A  
COVID SEATING LAYOUT  
3' SOCIAL DISTANCE

DRAWN BY: N. HUETTL

March 2021





702

1700A

734

1700B

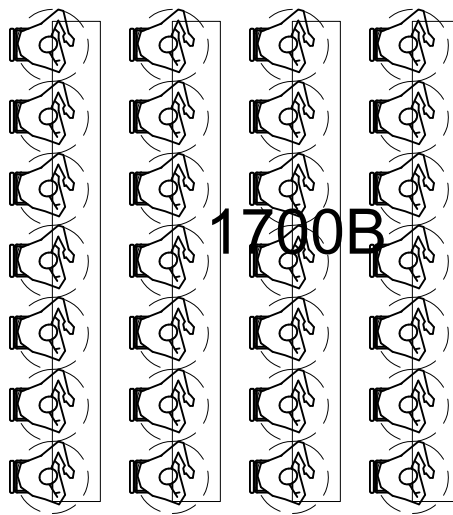

1714

plex

1720

SEATING CAPACITY	
NORMAL	32
COVID	28



MINNESOTA STATE  
UNIVERSITY  
MANKATO  
PLANNING & CONSTRUCTION

HIGHLAND CENTER 1700B  
COVID SEATING LAYOUT  
3' SOCIAL DISTANCE

DRAWN BY: N. HUETTL

March 2021

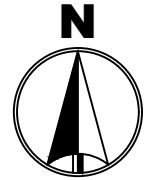

# 2004

# 2012

# 2010

<b>SEATING CAPACITY</b>	
NORMAL	36
COVID	36



**MINNESOTA STATE UNIVERSITY**  
MANKATO  
**PLANNING & CONSTRUCTION**

**HIGHLAND CENTER 2010**  
COVID SEATING LAYOUT  
3' SOCIAL DISTANCE

DRAWN BY: N. HUETTL

March 2021

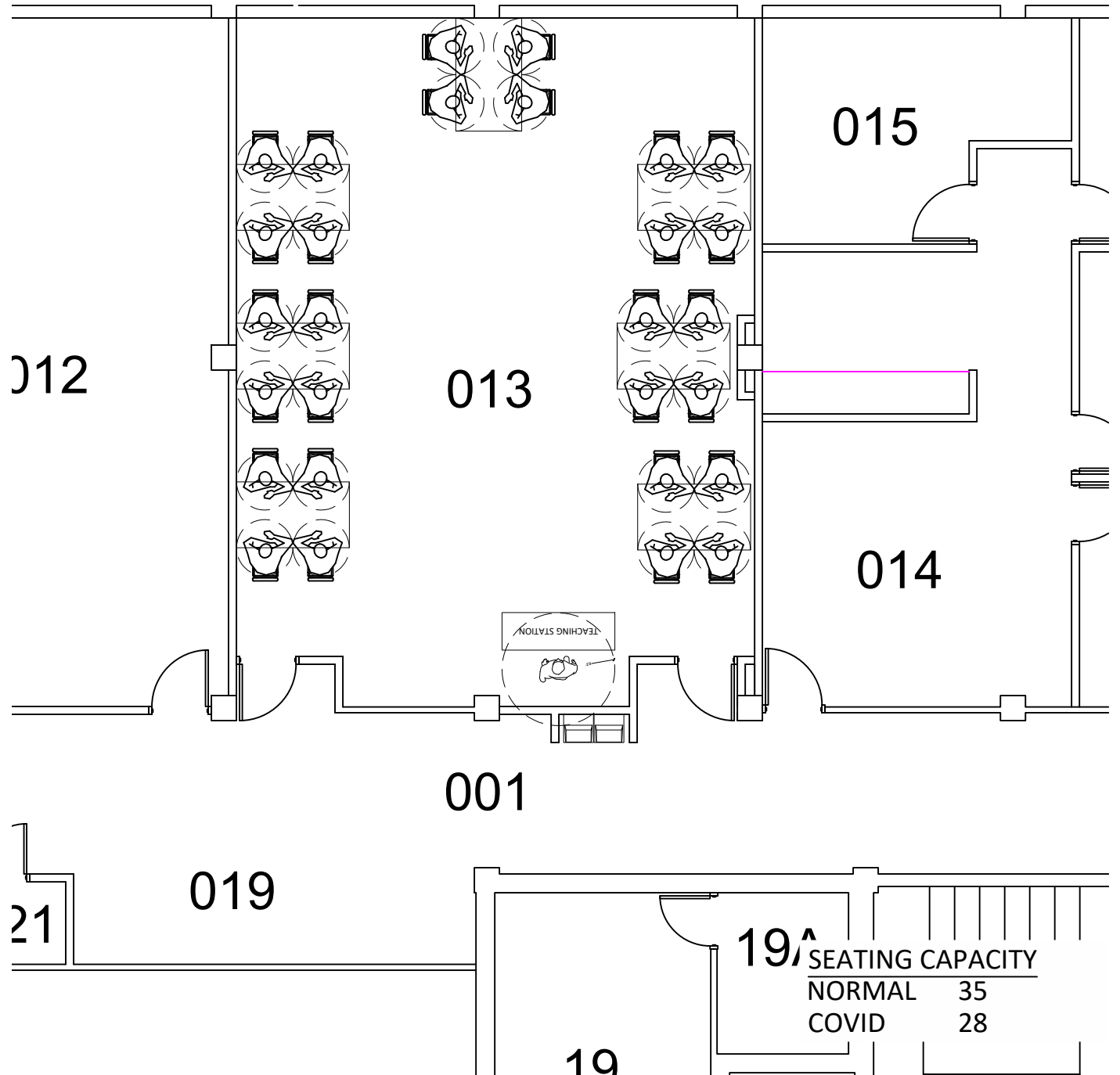
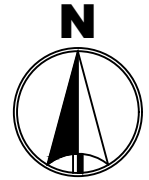

MINNESOTA STATE  
UNIVERSITY  
MANKATO  
PLANNING & CONSTRUCTION

MORRIS HALL 013  
COVID SEATING LAYOUT  
3' SOCIAL DISTANCE

DRAWN BY: N. HUETTL

March 2021

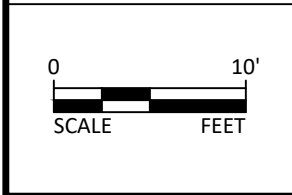
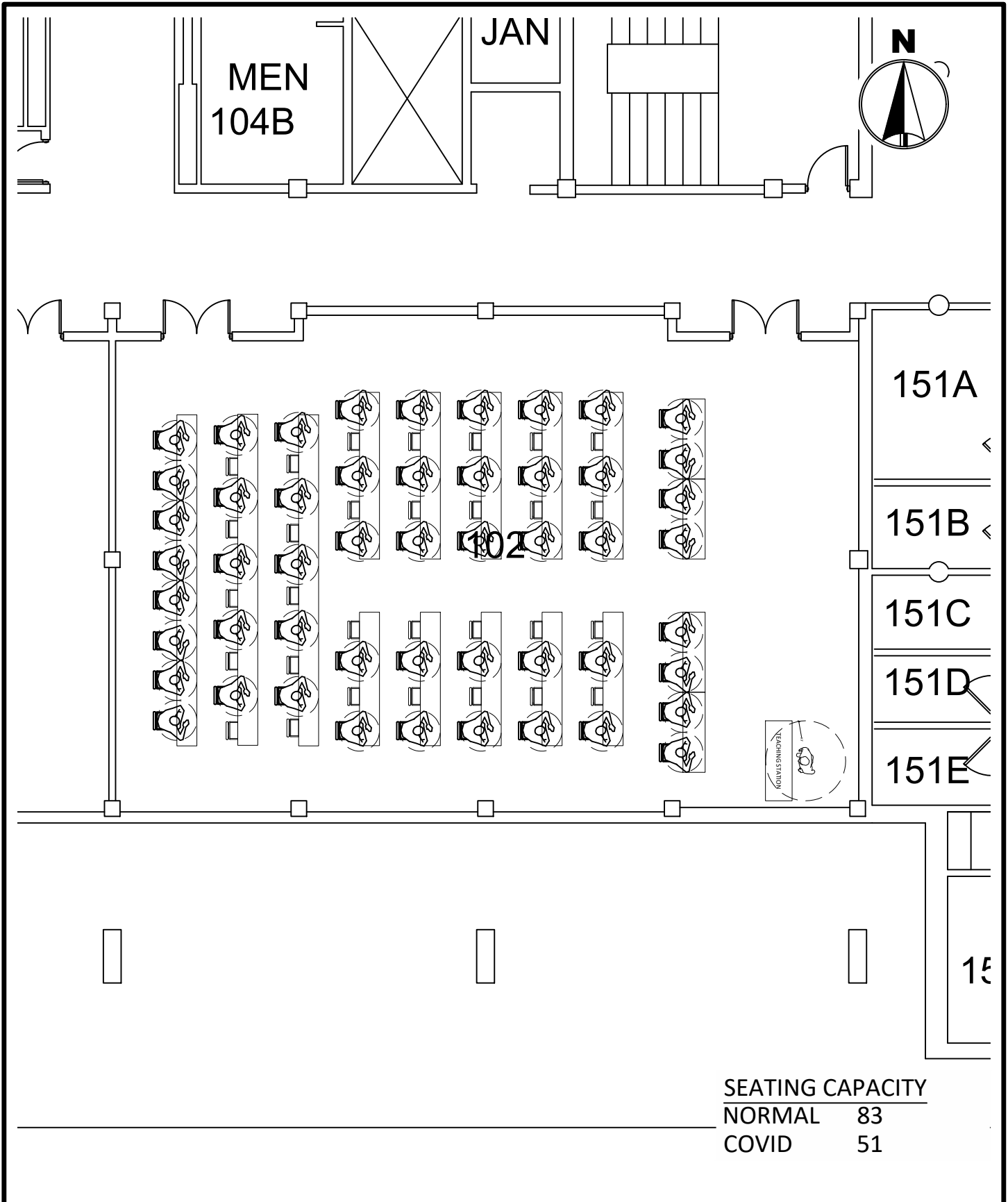

MINNESOTA STATE UNIVERSITY  
MANKATO  
PLANNING & CONSTRUCTION

MORRIS HALL 102  
COVID SEATING LAYOUT  
3' SOCIAL DISTANCE

DRAWN BY: N. HUETTL March 2021

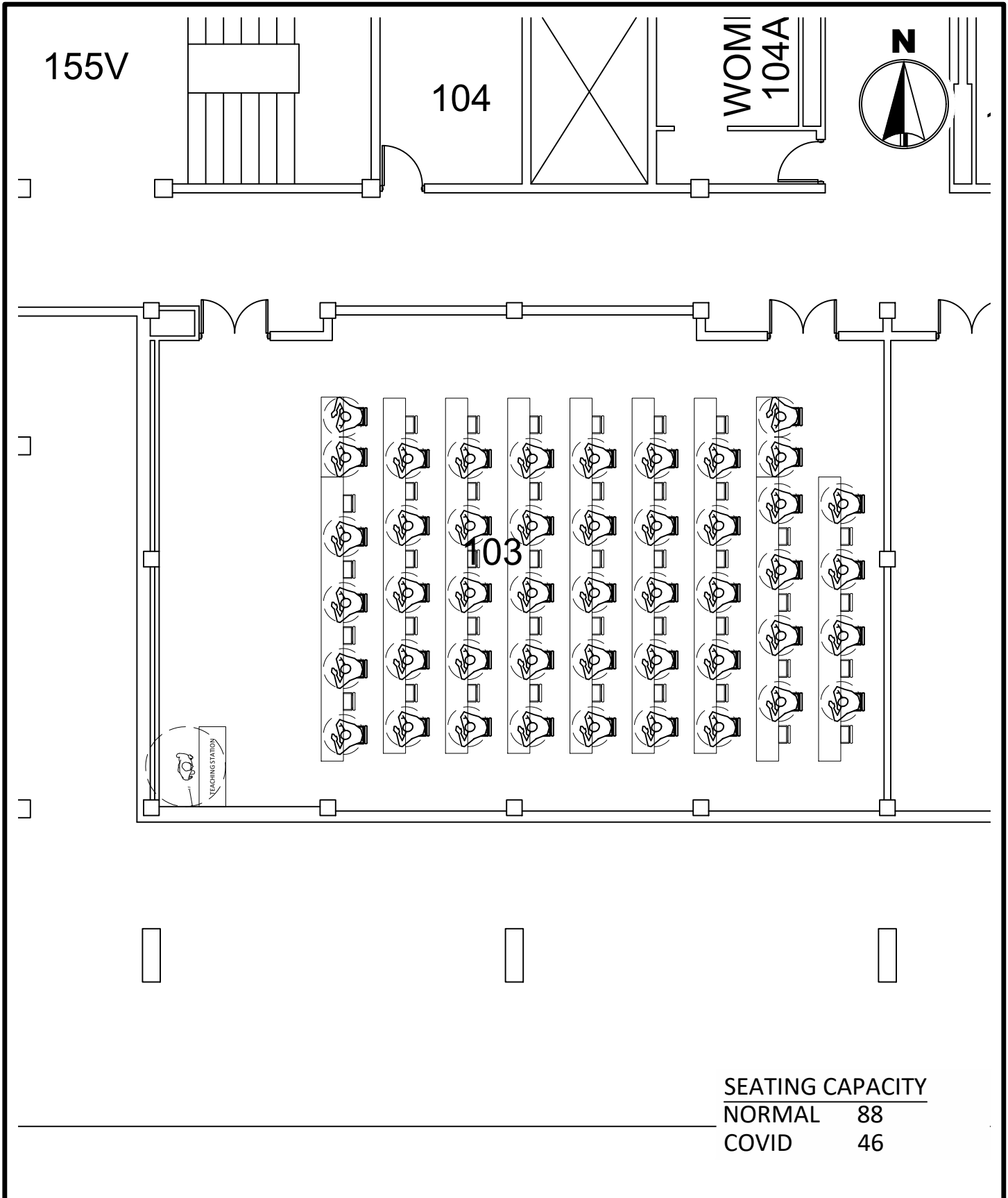

SEATING CAPACITY	
NORMAL	88
COVID	46

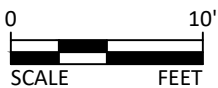

MINNESOTA STATE  
UNIVERSITY  
MANKATO  
PLANNING & CONSTRUCTION

MORRIS HALL 103  
COVID SEATING LAYOUT  
3' SOCIAL DISTANCE

DRAWN BY: N. HUETTL

March 2021

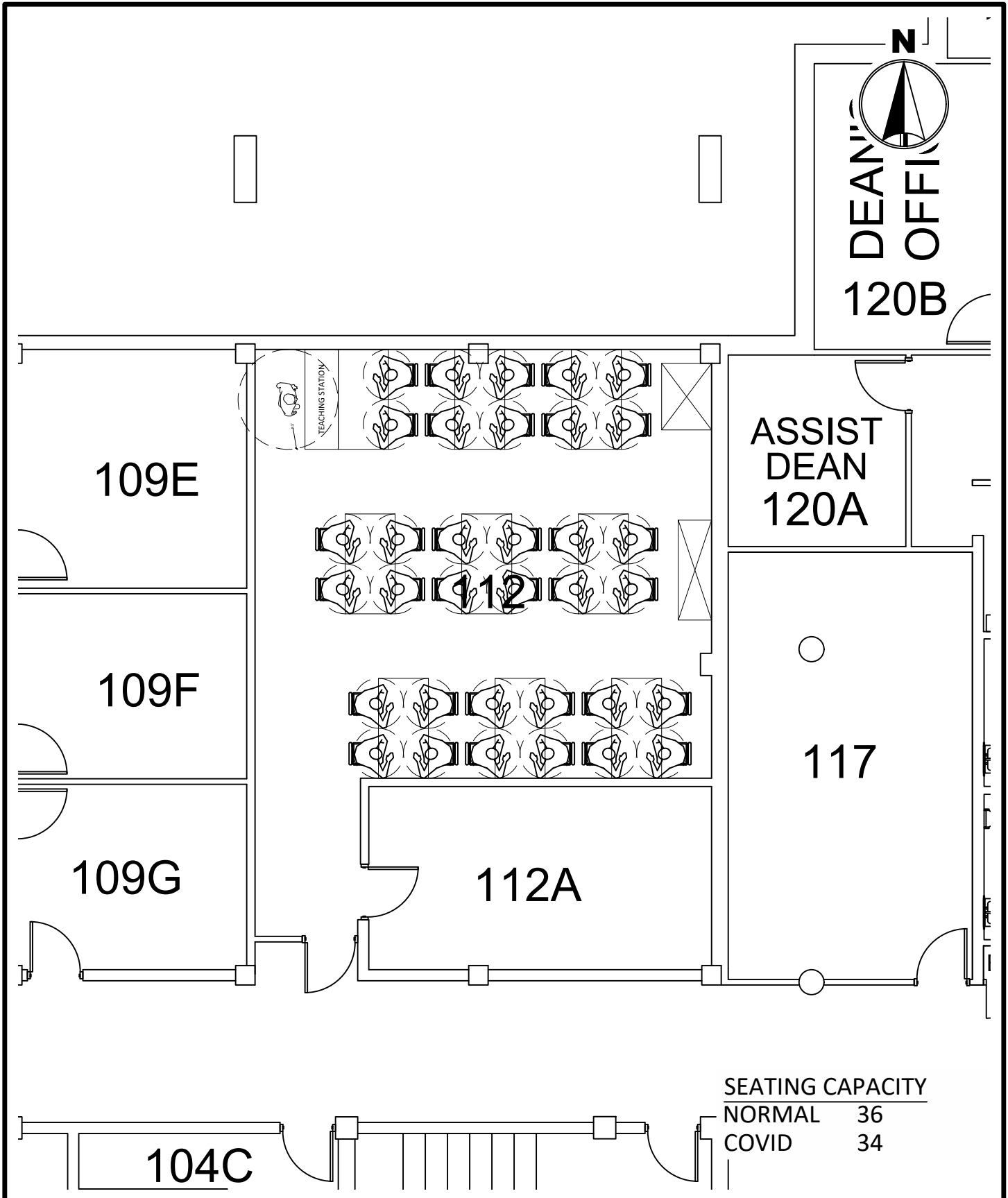

MINNESOTA STATE UNIVERSITY  
MANKATO  
PLANNING & CONSTRUCTION

MORRIS HALL 112  
COVID SEATING LAYOUT  
3' SOCIAL DISTANCE

DRAWN BY: N. HUETTL March 2021

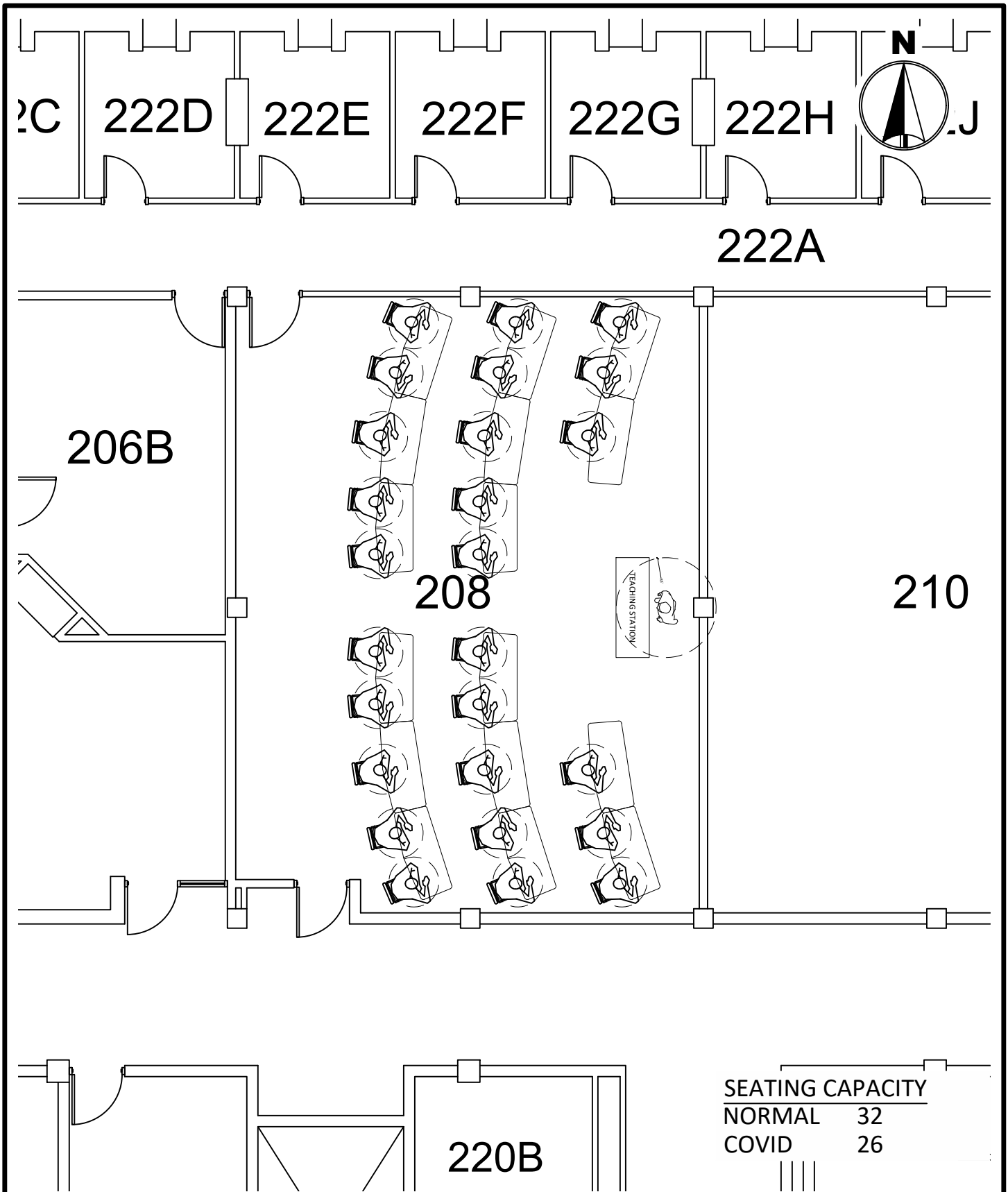

SEATING CAPACITY	
NORMAL	32
COVID	26

220B

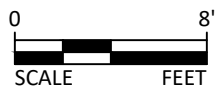

MINNESOTA STATE UNIVERSITY  
MANKATO  
PLANNING & CONSTRUCTION

MORRIS HALL 208  
COVID SEATING LAYOUT  
3' SOCIAL DISTANCE

DRAWN BY: N. HUETTL March 2021

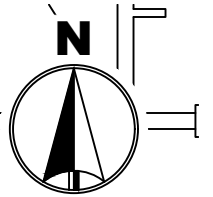

203

207A

207B

207C

209

21

TEACHING STATION

221B

221C

221D

221F

221G

SEATING CAPACITY	
NORMAL	36
COVID	36



MINNESOTA STATE UNIVERSITY  
MANKATO

PLANNING & CONSTRUCTION

MORRIS HALL 209  
COVID SEATING LAYOUT  
3' SOCIAL DISTANCE

DRAWN BY: N. HUETTL

March 2021



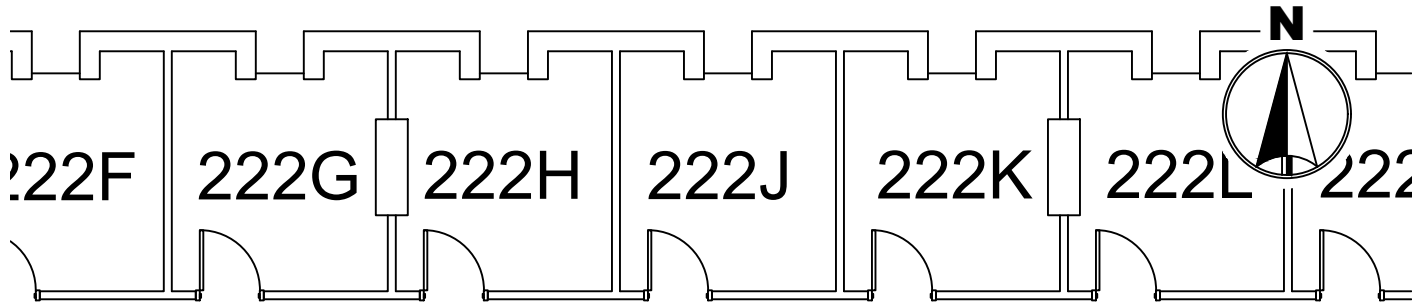

222A

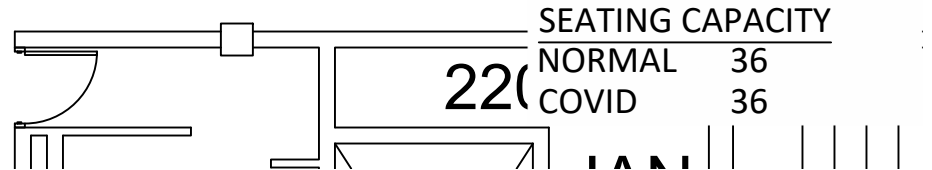
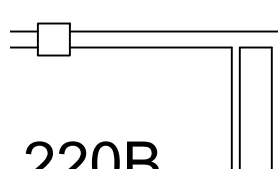
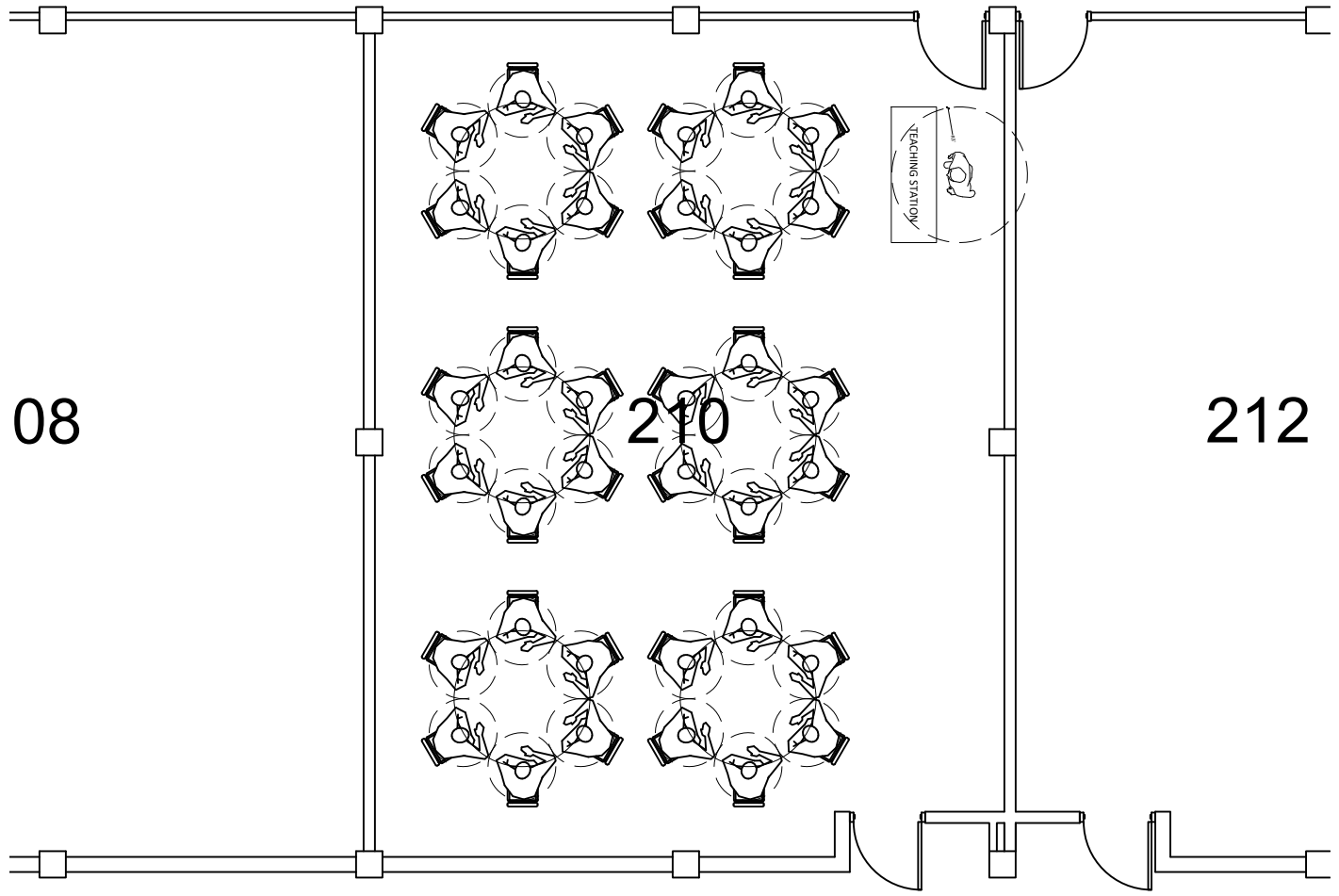

SEATING CAPACITY	
NORMAL	36
COVID	36

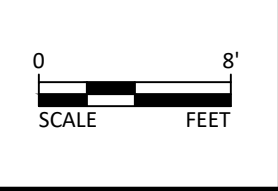

**MINNESOTA STATE UNIVERSITY**  
MANKATO  
PLANNING & CONSTRUCTION

**MORRIS HALL 210**  
COVID SEATING LAYOUT  
3' SOCIAL DISTANCE  
DRAWN BY: N. HUETTL March 2021

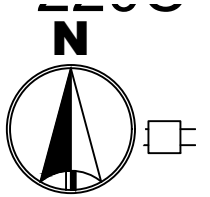
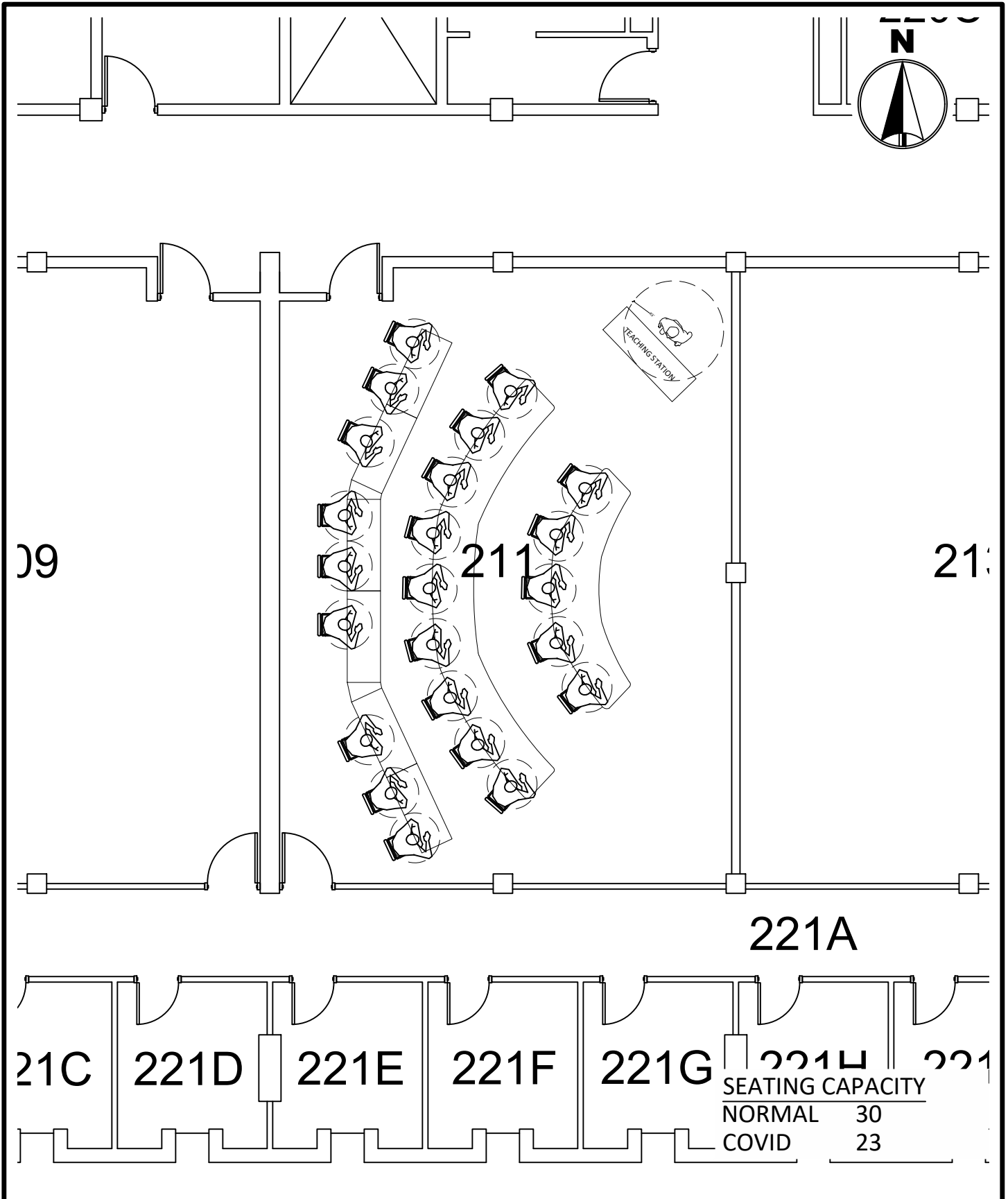

MINNESOTA STATE  
UNIVERSITY  
MANKATO  
PLANNING & CONSTRUCTION

MORRIS HALL 211  
COVID SEATING LAYOUT  
3' SOCIAL DISTANCE

DRAWN BY: N. HUETTL

March 2021

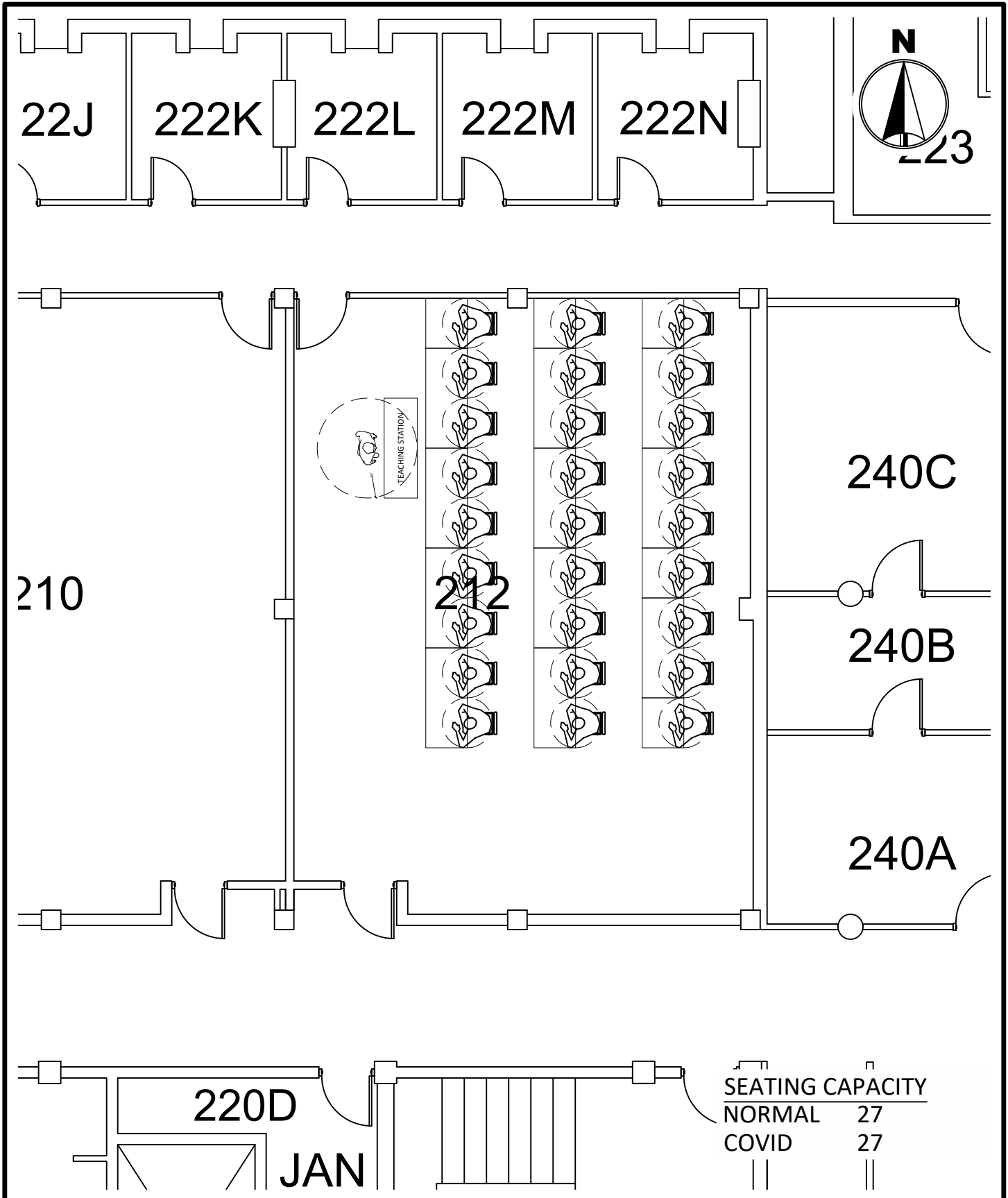

**MINNESOTA STATE UNIVERSITY**  
MANKATO  
**PLANNING & CONSTRUCTION**

**MORRIS HALL 212**  
COVID SEATING LAYOUT  
3' SOCIAL DISTANCE

DRAWN BY: N. HUETTL March 2021

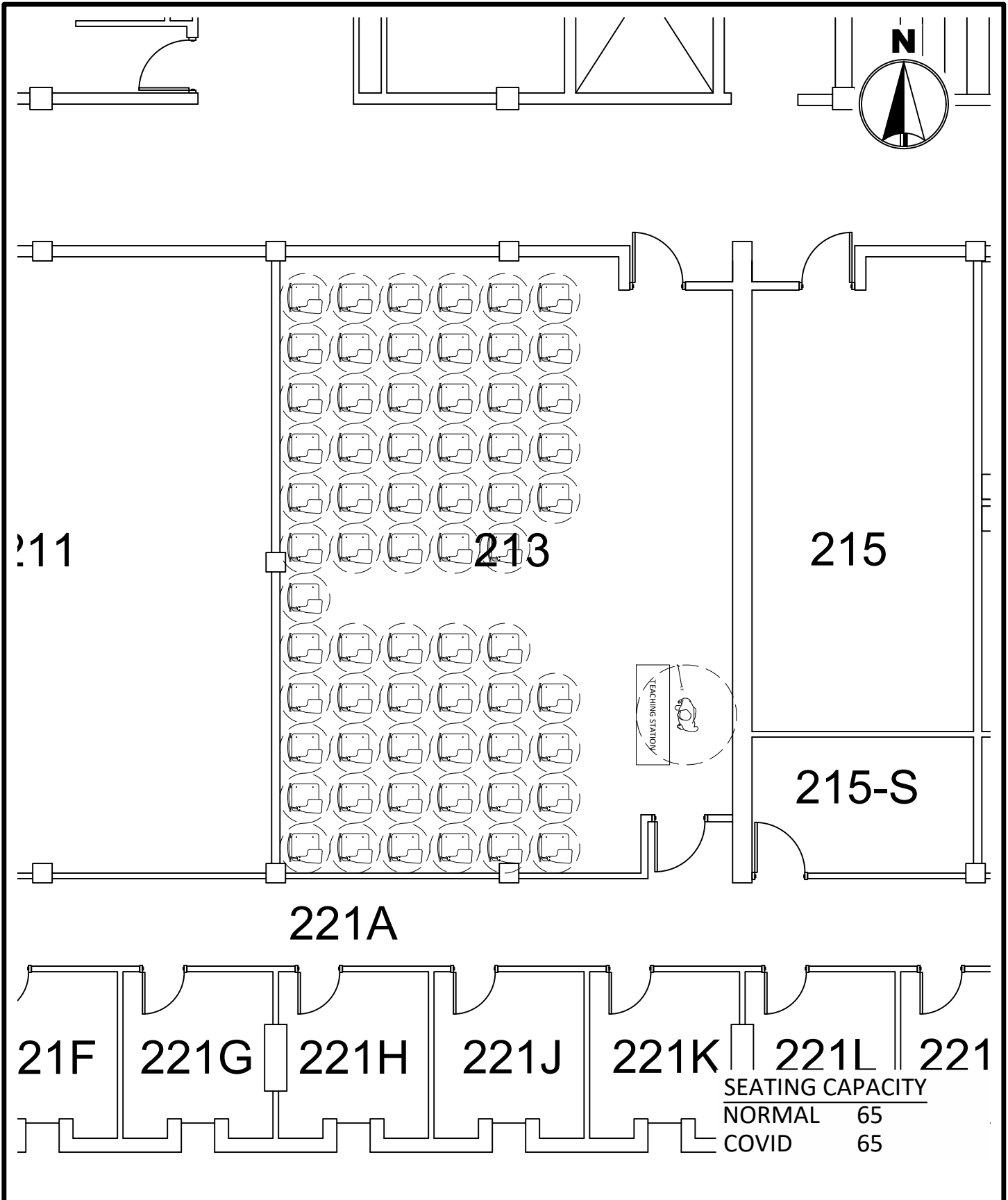

MINNESOTA STATE  
UNIVERSITY  
MANKATO  
PLANNING & CONSTRUCTION

MORRIS HALL 213  
COVID SEATING LAYOUT  
3' SOCIAL DISTANCE

DRAWN BY: N. HUETTL

March 2021

0135



0:

1C

UP

0047

TEACHING STATION

SEATING CAPACITY	
NORMAL	40
COVID	40



**MINNESOTA STATE UNIVERSITY**  
MANKATO  
**PLANNING & CONSTRUCTION**

**MEMORIAL LIBRARY 0047**  
COVID SEATING LAYOUT  
3' SOCIAL DISTANCE

DRAWN BY: N. HUETTL

March 2021

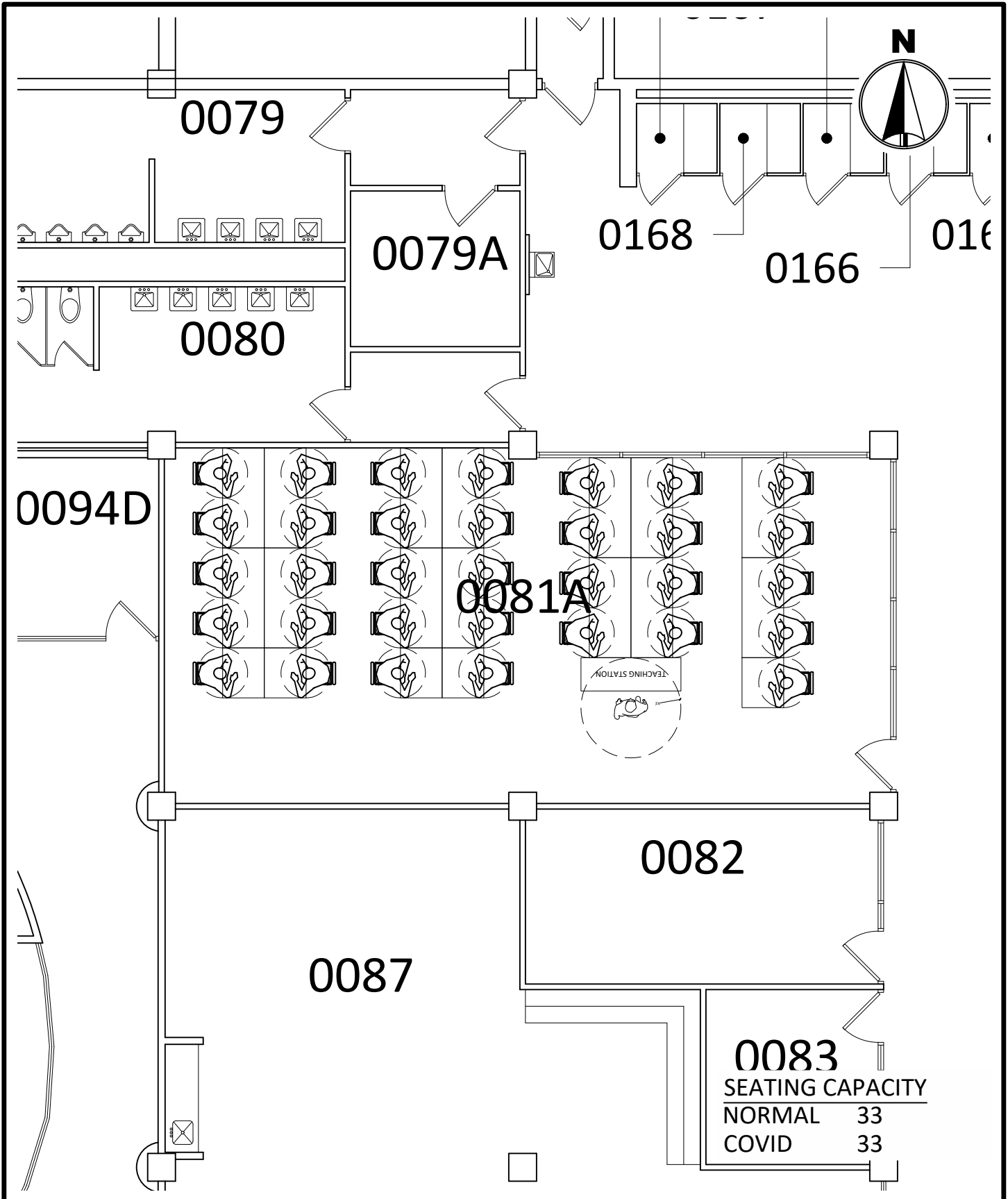

<b>0083</b>	
SEATING CAPACITY	
NORMAL	33
COVID	33



**MINNESOTA STATE UNIVERSITY**  
MANKATO  
PLANNING & CONSTRUCTION

**MEMORIAL LIBRARY 0081**  
COVID SEATING LAYOUT  
3' SOCIAL DISTANCE

DRAWN BY: N. HUETTL

March 2021

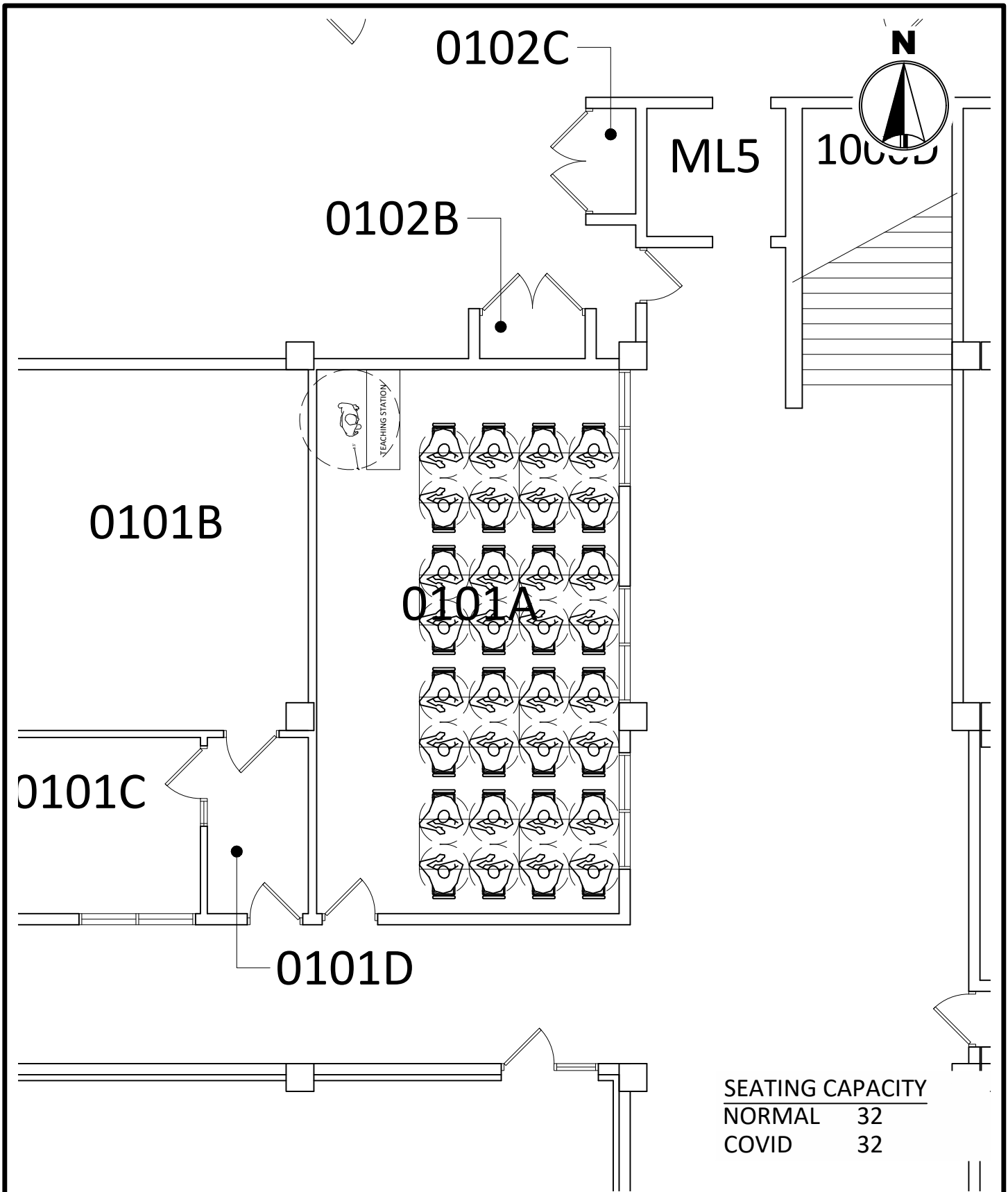

SEATING CAPACITY	
NORMAL	32
COVID	32



**MINNESOTA STATE UNIVERSITY**  
MANKATO  
**PLANNING & CONSTRUCTION**

**MEMORIAL LIBRARY 0101A**  
COVID SEATING LAYOUT  
3' SOCIAL DISTANCE

DRAWN BY: N. HUETTL

March 2021

0102

0102C N<sub>1</sub>



0102B

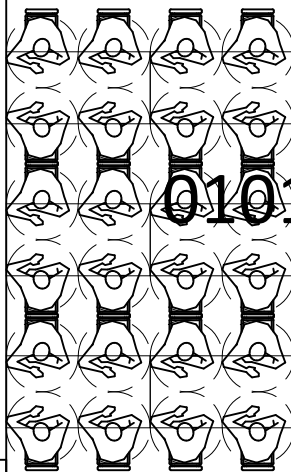

0101B

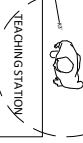

0101A

0103

0101C

0101D

0101D

0113

0113

SEATING CAPACITY	
NORMAL	24
COVID	24



MINNESOTA STATE UNIVERSITY  
MANKATO

PLANNING & CONSTRUCTION

MEMORIAL LIBRARY 0101B  
COVID SEATING LAYOUT  
3' SOCIAL DISTANCE

DRAWN BY: N. HUETTL

March 2021



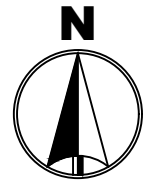

0101D

0113

01

0112C

0109

0112D

100C

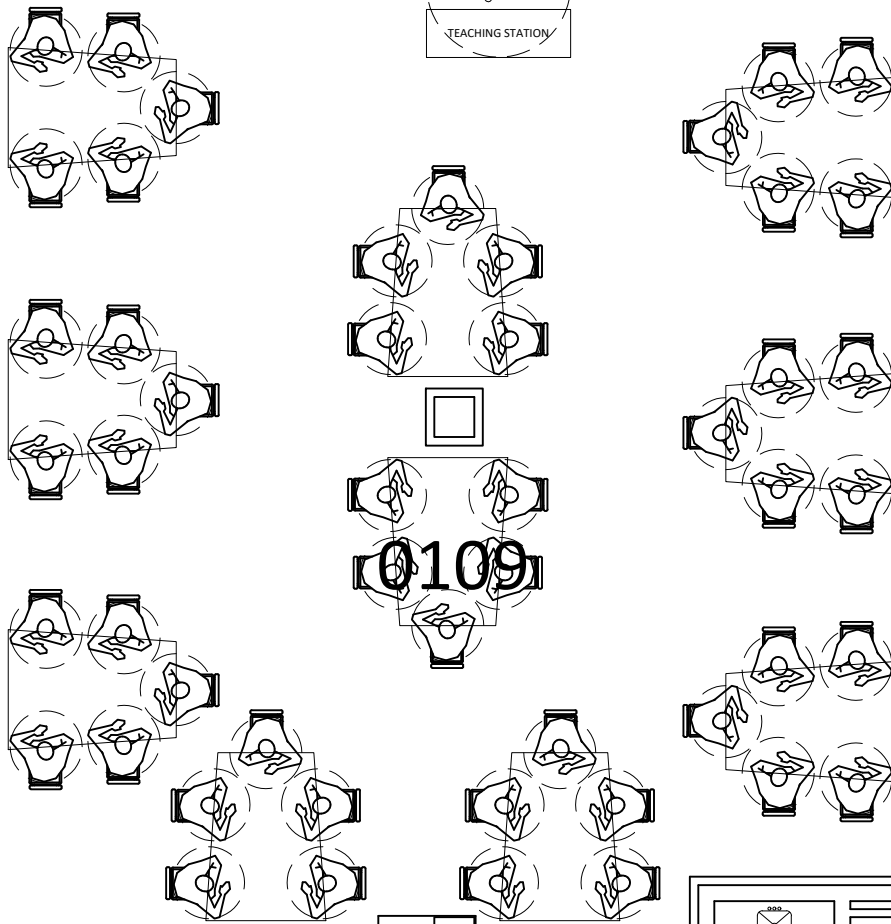
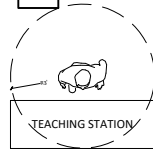

SEATING CAPACITY	
NORMAL	50
COVID	50



MINNESOTA STATE  
UNIVERSITY  
MANKATO  
PLANNING & CONSTRUCTION

MEMORIAL LIBRARY 0109  
COVID SEATING LAYOUT  
3' SOCIAL DISTANCE

DRAWN BY: N. HUETTL

March 2021

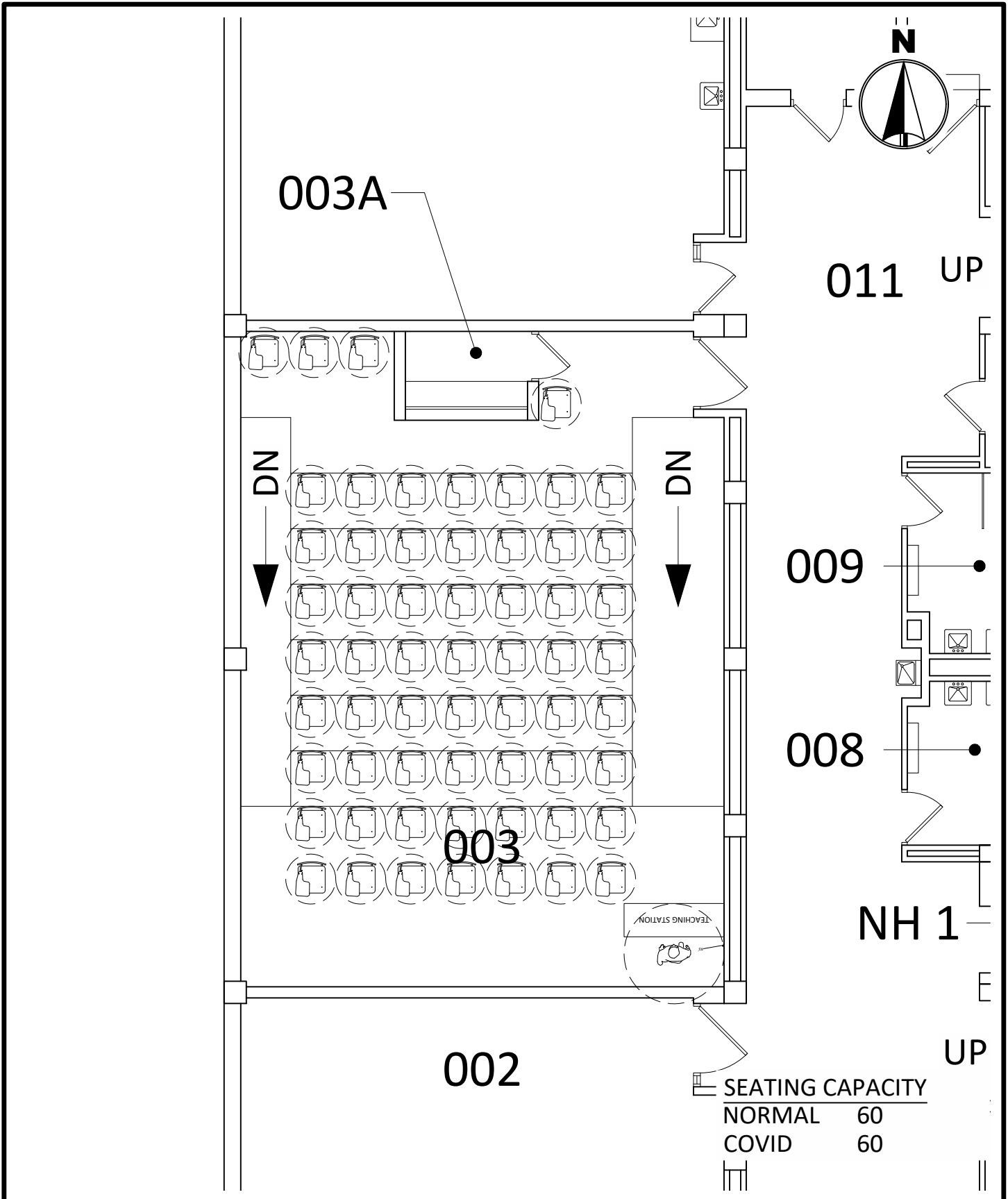

SEATING CAPACITY	
NORMAL	60
COVID	60



**MINNESOTA STATE UNIVERSITY**  
MANKATO  
**PLANNING & CONSTRUCTION**

**NELSON HALL 003**  
COVID SEATING LAYOUT  
3' SOCIAL DISTANCE

DRAWN BY: N. HUETTL March 2021

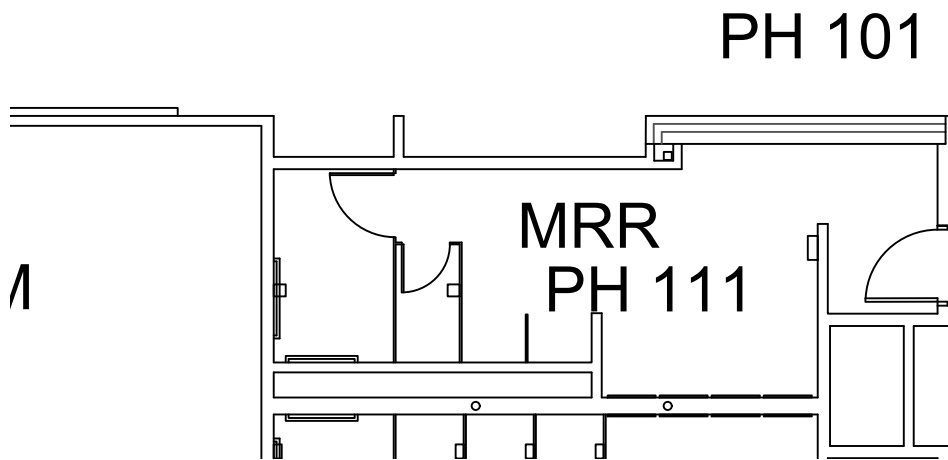
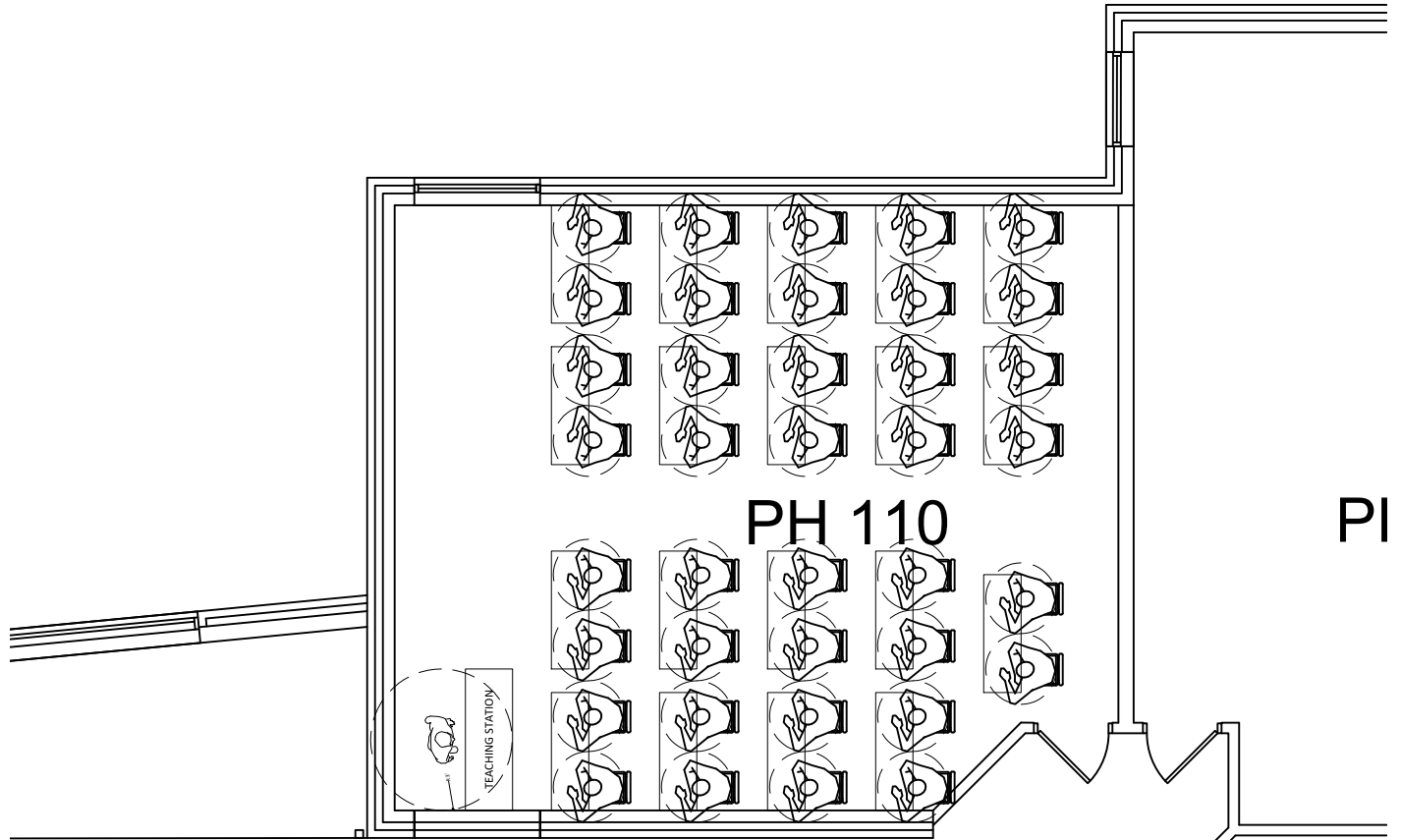
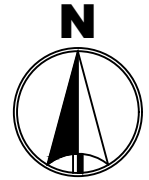

SEATING CAPACITY	
NORMAL	38
COVID	38



**MINNESOTA STATE UNIVERSITY**  
MANKATO  
**PLANNING & CONSTRUCTION**

**PENNINGTON HALL 110**  
COVID SEATING LAYOUT  
3' SOCIAL DISTANCE

DRAWN BY: N. HUETTL

March 2021

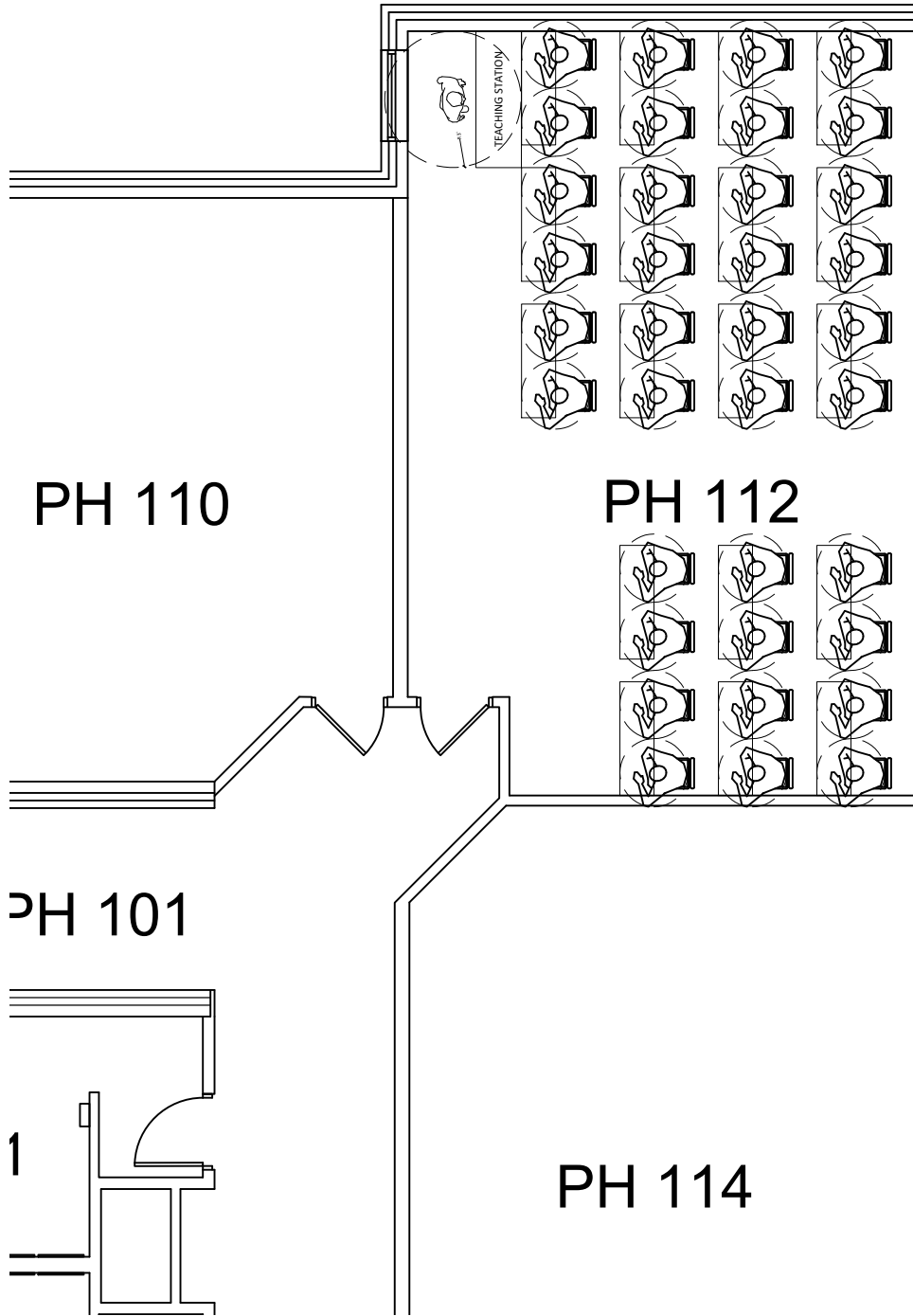

Observation  
PH 118

SEATING CAPACITY	
NORMAL	36
COVID	36



MINNESOTA STATE  
UNIVERSITY  
MANKATO  
PLANNING & CONSTRUCTION

PENNINGTON HALL 112  
COVID SEATING LAYOUT  
3' SOCIAL DISTANCE

DRAWN BY: N. HUETTL

March 2021

Observation  
 P  3

PH 110

PH 112

PH 101

1

R  
113

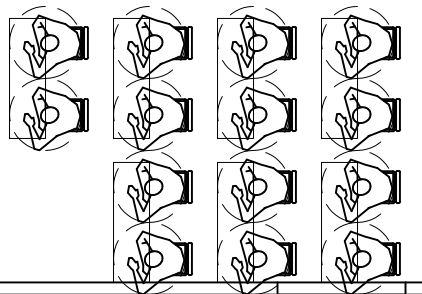
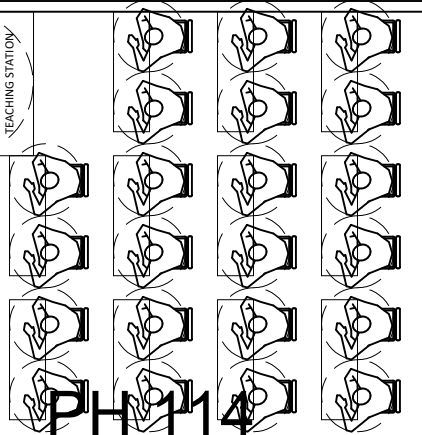

PH 101

116

SEATING CAPACITY	
NORMAL	36
COVID	36



MINNESOTA STATE  
 UNIVERSITY  
 MANKATO

PLANNING & CONSTRUCTION

PENNINGTON HALL 114  
 COVID SEATING LAYOUT  
 3' SOCIAL DISTANCE

DRAWN BY: N. HUETTL

March 2021

WIN  
COM

MRR  
PH 111

WRR  
PH 113

Mechanical  
PH 108

PH 116

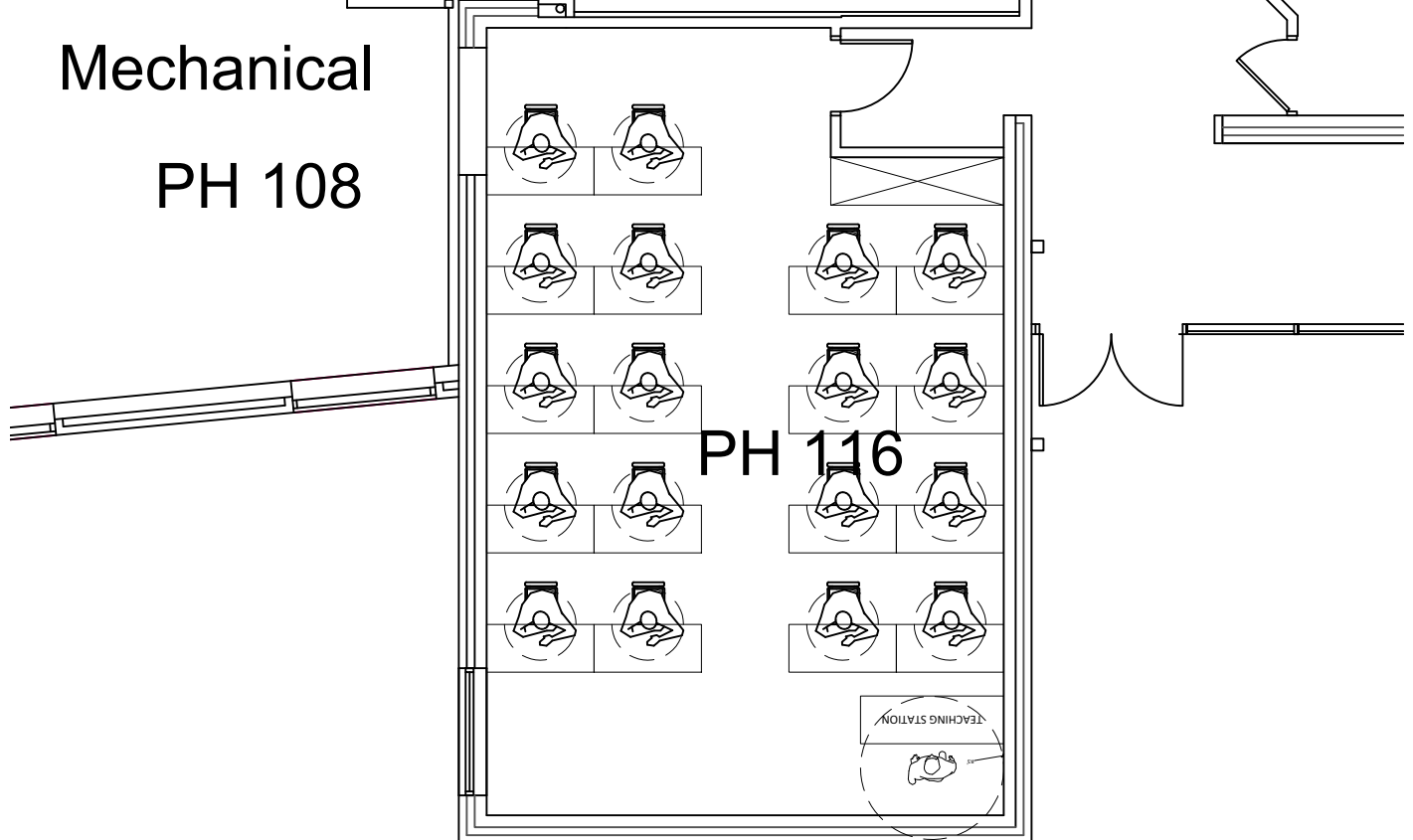

SEATING CAPACITY	
NORMAL	38
COVID	18



MINNESOTA STATE  
UNIVERSITY  
MANKATO  
PLANNING & CONSTRUCTION

PENNINGTON HALL 116  
COVID SEATING LAYOUT  
3' SOCIAL DISTANCE

DRAWN BY: N. HUETTL

March 2021

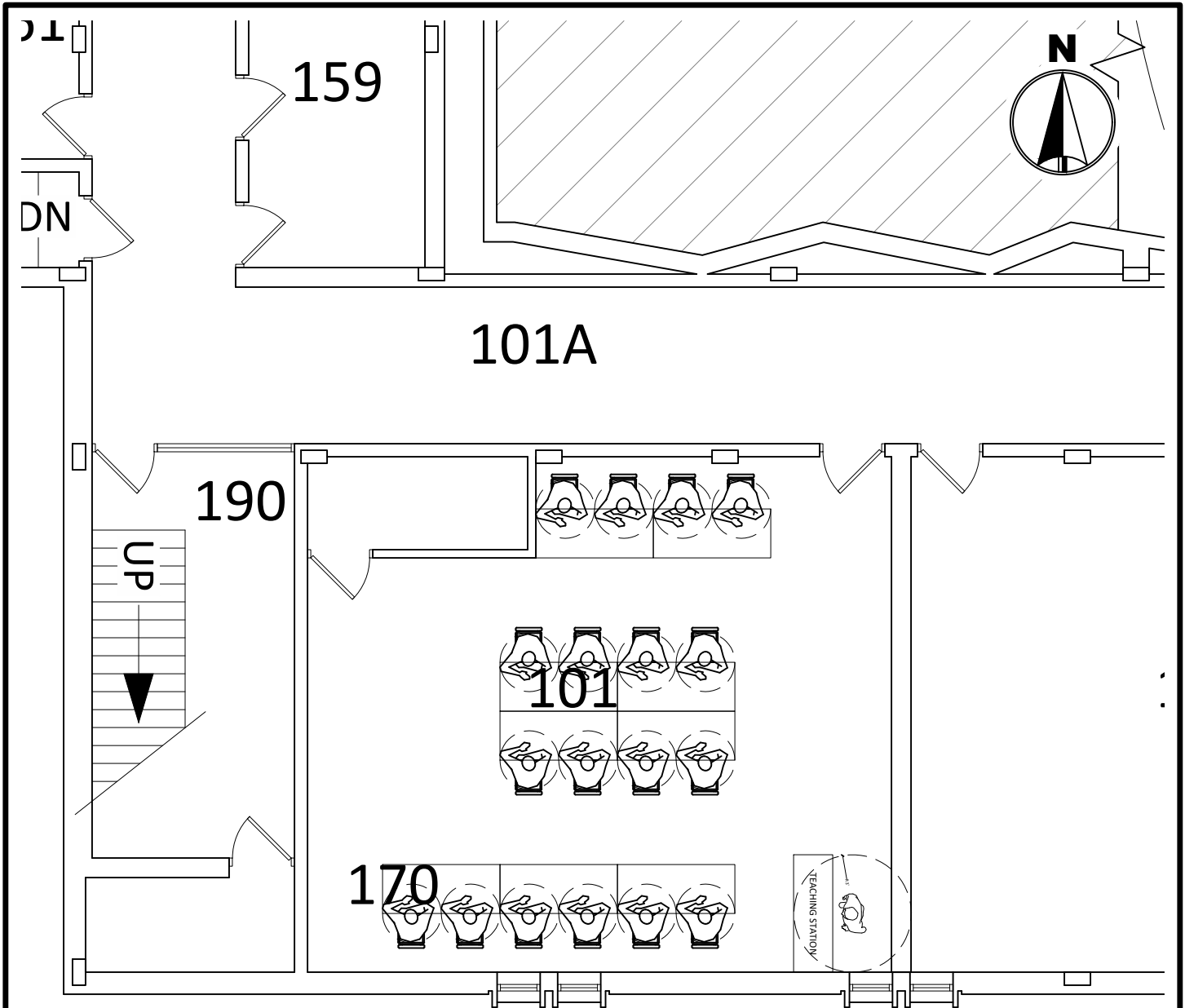

SEATING CAPACITY	
NORMAL	32
COVID	18



**MINNESOTA STATE UNIVERSITY**  
MANKATO  
PLANNING & CONSTRUCTION

**PERFORMING ARTS 101**  
COVID SEATING LAYOUT  
3' SOCIAL DISTANCE

DRAWN BY: N. HUETTL

March 2021

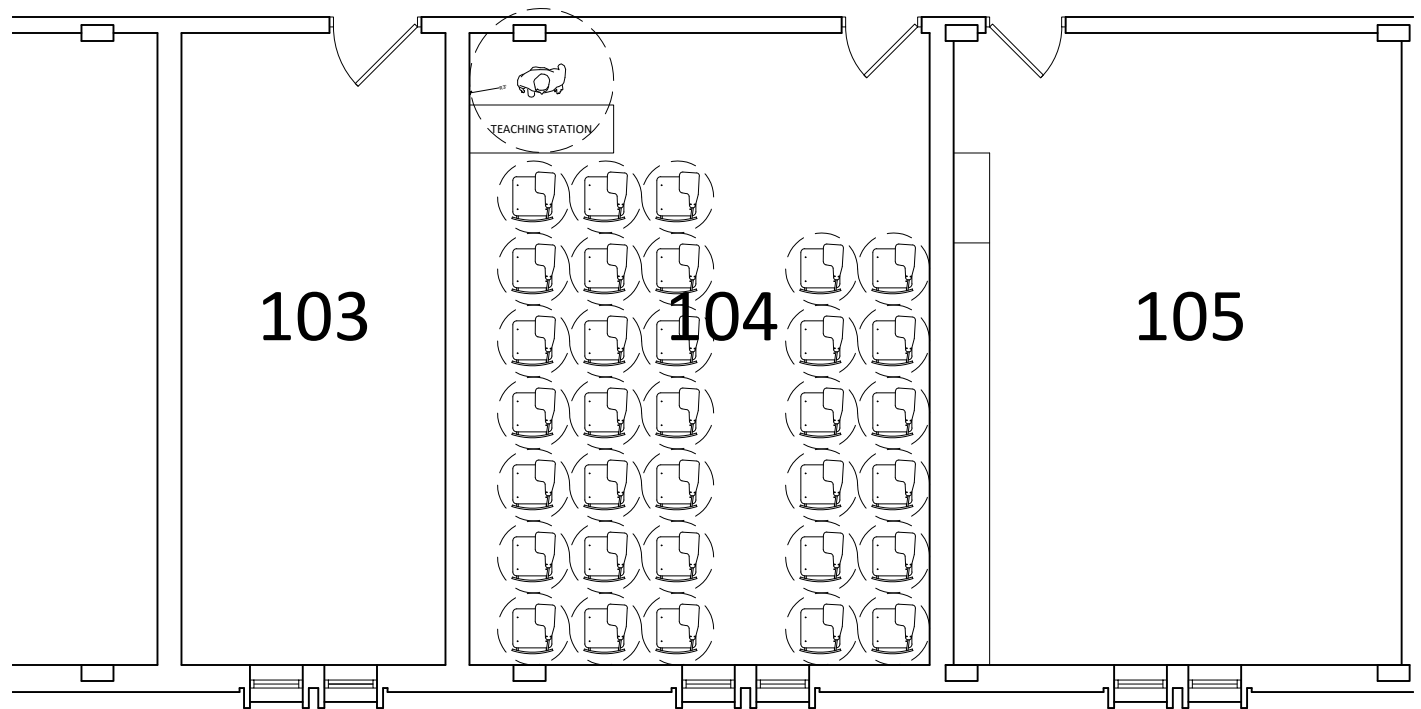
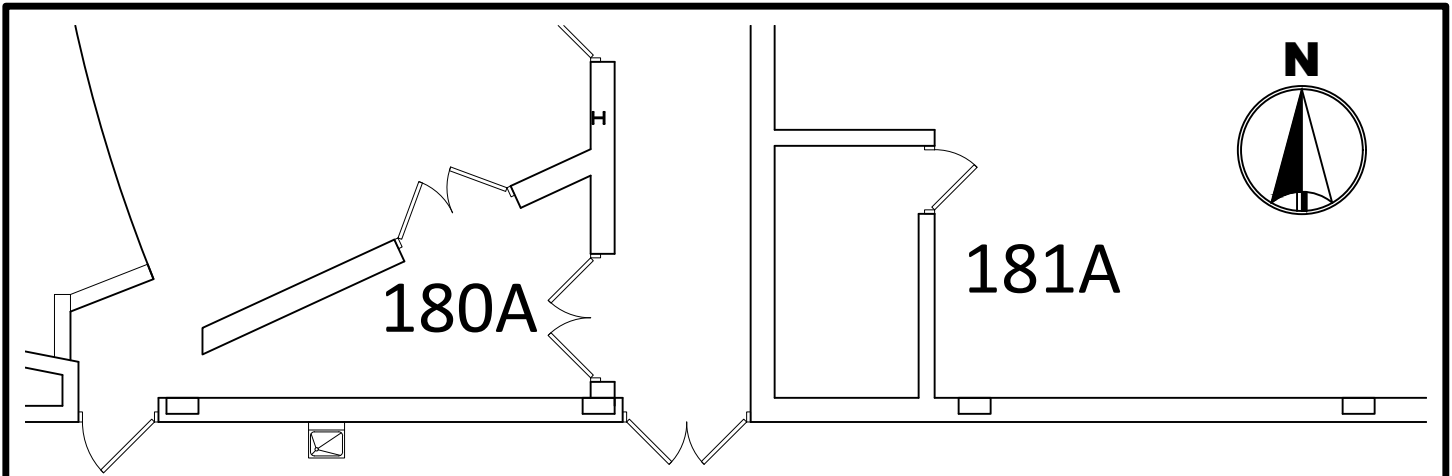

SEATING CAPACITY	
NORMAL	33
COVID	33



**MINNESOTA STATE UNIVERSITY**  
MANKATO  
**PLANNING & CONSTRUCTION**

**PERFORMING ARTS 104**  
COVID SEATING LAYOUT  
3' SOCIAL DISTANCE

DRAWN BY: N. HUETTL

March 2021



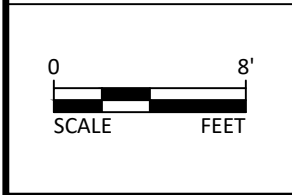
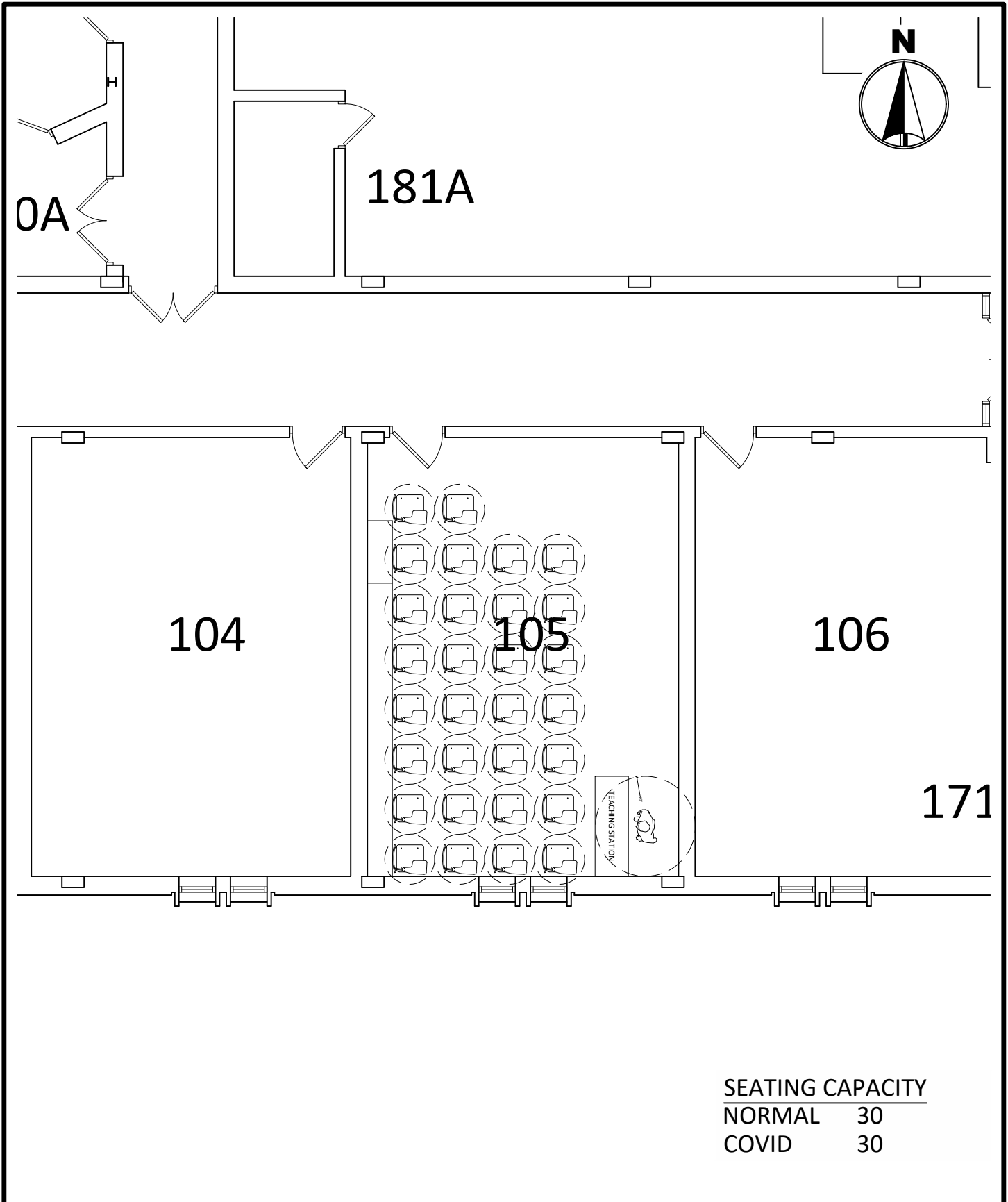

**MINNESOTA STATE UNIVERSITY**  
MANKATO  
**PLANNING & CONSTRUCTION**

**PERFORMING ARTS 105**  
COVID SEATING LAYOUT  
3' SOCIAL DISTANCE

DRAWN BY: N. HUETTL      March 2021

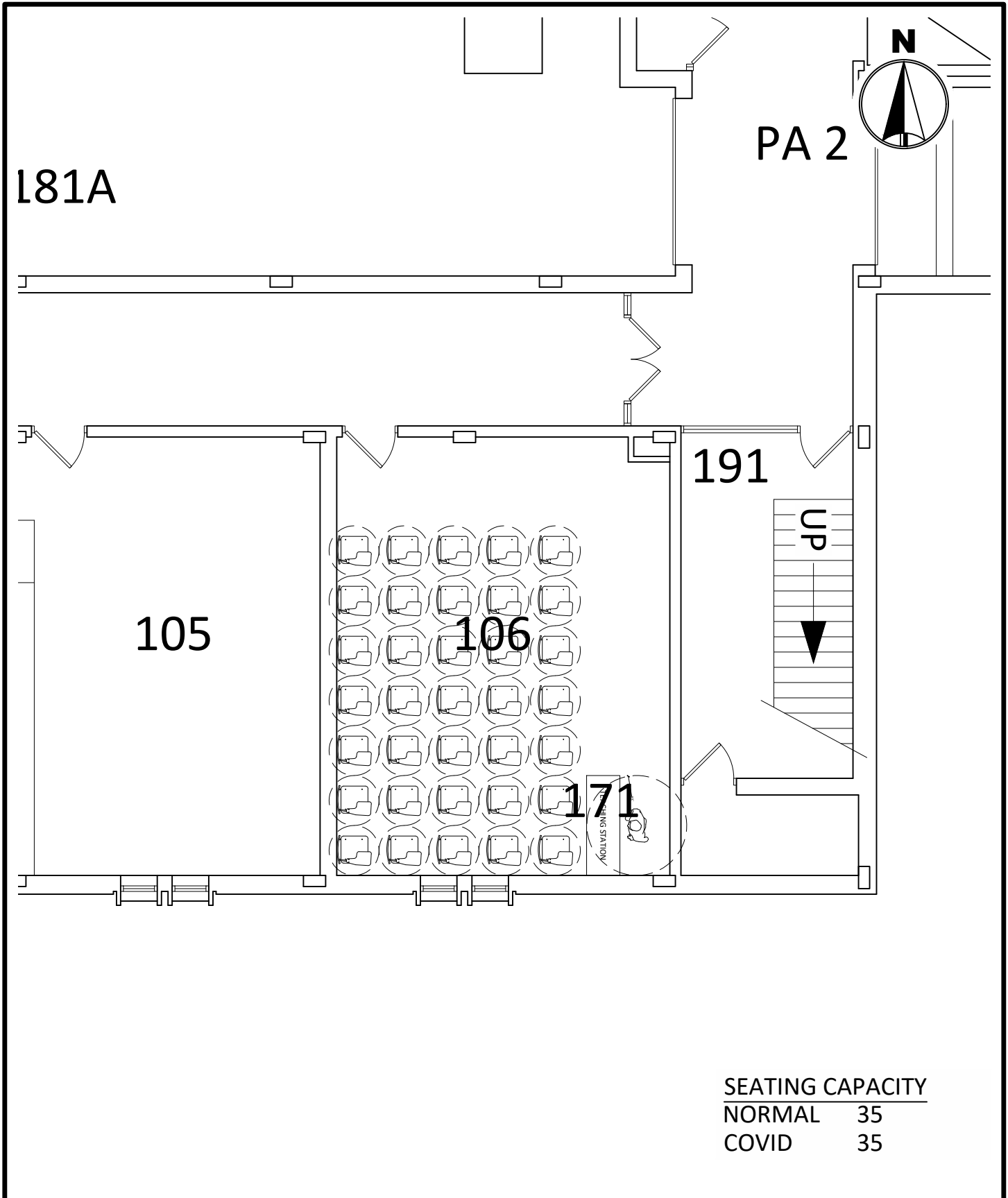

SEATING CAPACITY	
NORMAL	35
COVID	35



MINNESOTA STATE  
UNIVERSITY  
MANKATO  
PLANNING & CONSTRUCTION

PERFORMING ARTS 106  
COVID SEATING LAYOUT  
3' SOCIAL DISTANCE

DRAWN BY: N. HUETTL

March 2021

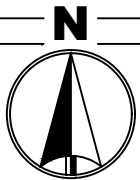

241

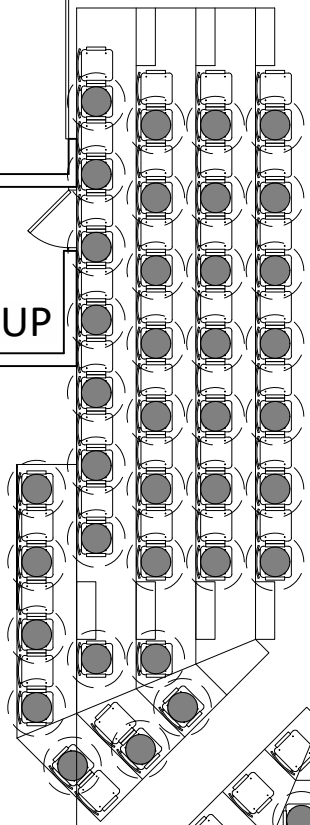
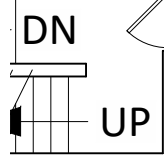

242

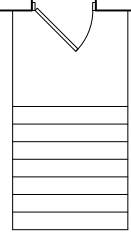
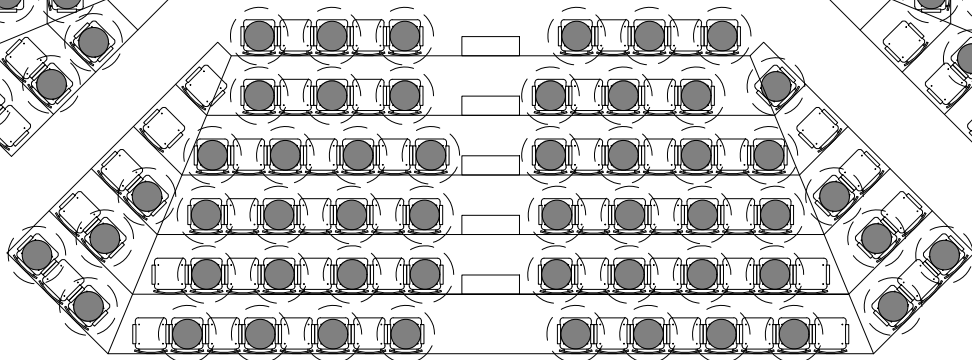
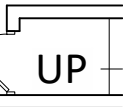
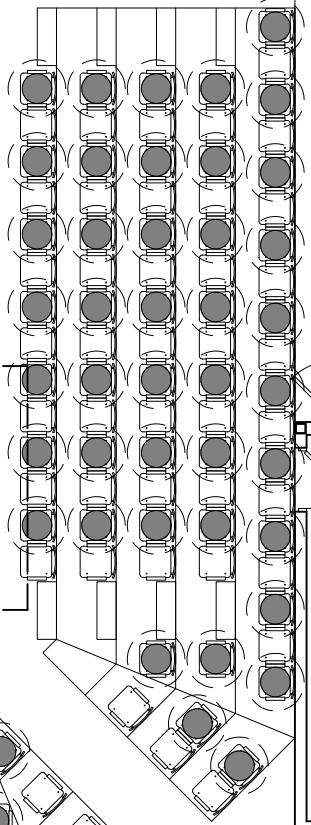

SEATING CAPACITY	
NORMAL	250
COVID	132



**MINNESOTA STATE UNIVERSITY**  
MANKATO  
**PLANNING & CONSTRUCTION**

**PERFORMING ARTS 242**  
COVID SEATING LAYOUT  
3' SOCIAL DISTANCE

DRAWN BY: N. HUETTL March 2021

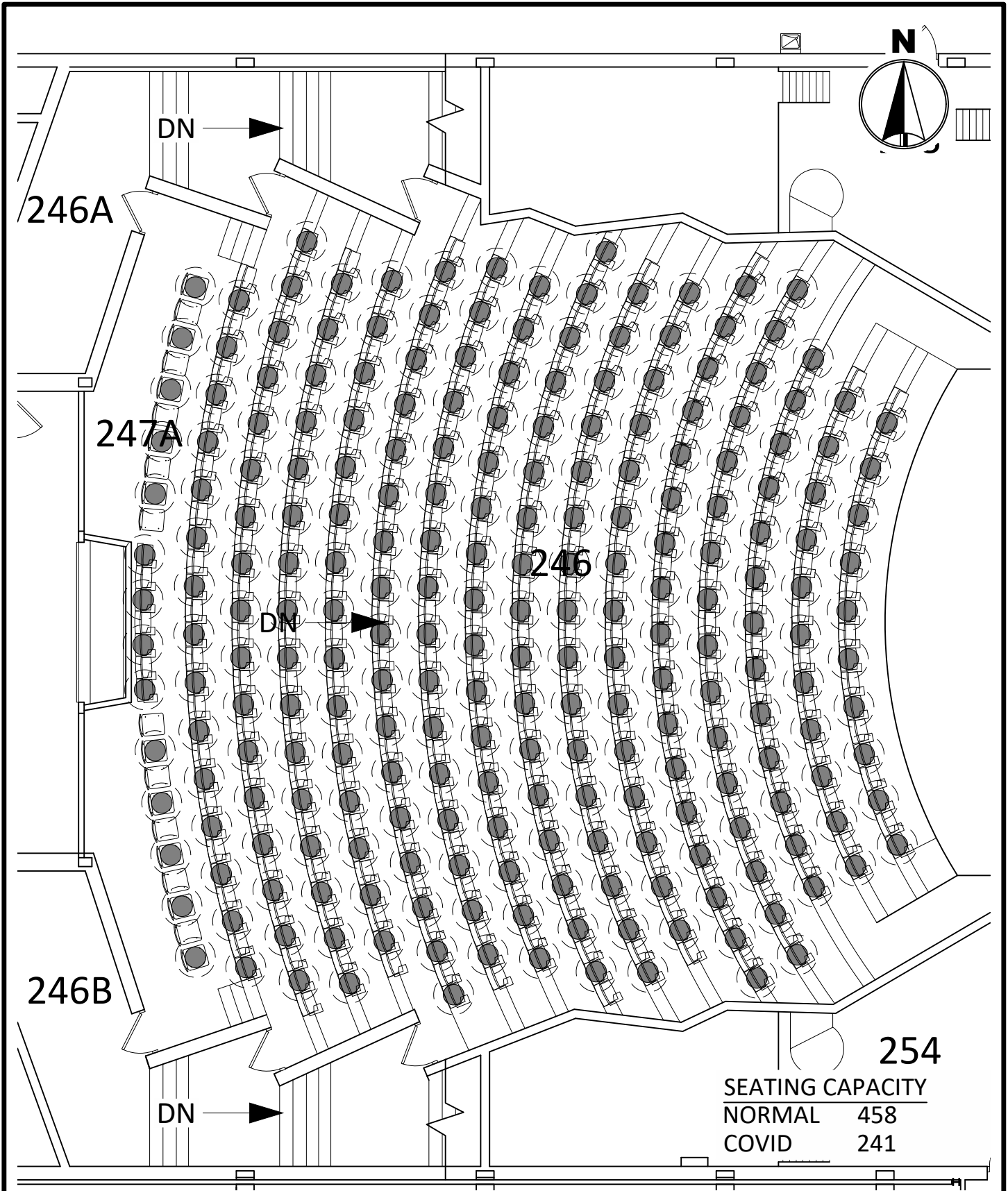

<b>254</b>	
<b>SEATING CAPACITY</b>	
<b>NORMAL</b>	<b>458</b>
<b>COVID</b>	<b>241</b>



**MINNESOTA STATE UNIVERSITY**  
MANKATO  
**PLANNING & CONSTRUCTION**

**PERFORMING ARTS 246**  
**COVID SEATING LAYOUT**  
**3' SOCIAL DISTANCE**

**DRAWN BY: N. HUETTL** **March 2021**

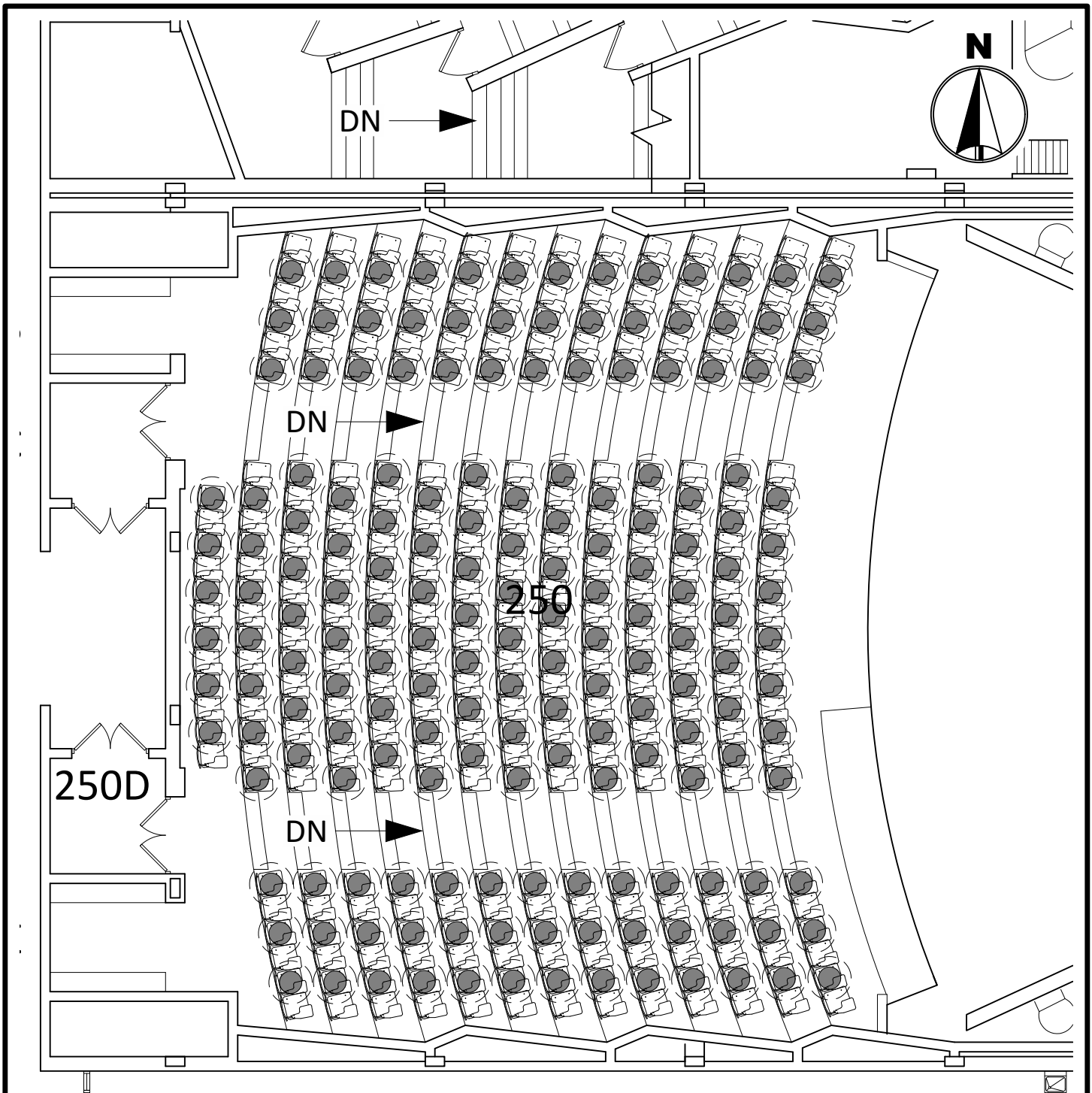

250D

DN

DN

250

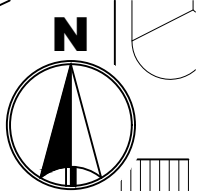

SEATING CAPACITY	
NORMAL	350
COVID	175

201B

202B



MINNESOTA STATE UNIVERSITY  
MANKATO  
PLANNING & CONSTRUCTION

PERFORMING ARTS 250  
COVID SEATING LAYOUT  
3' SOCIAL DISTANCE

DRAWN BY: N. HUETTL

March 2021

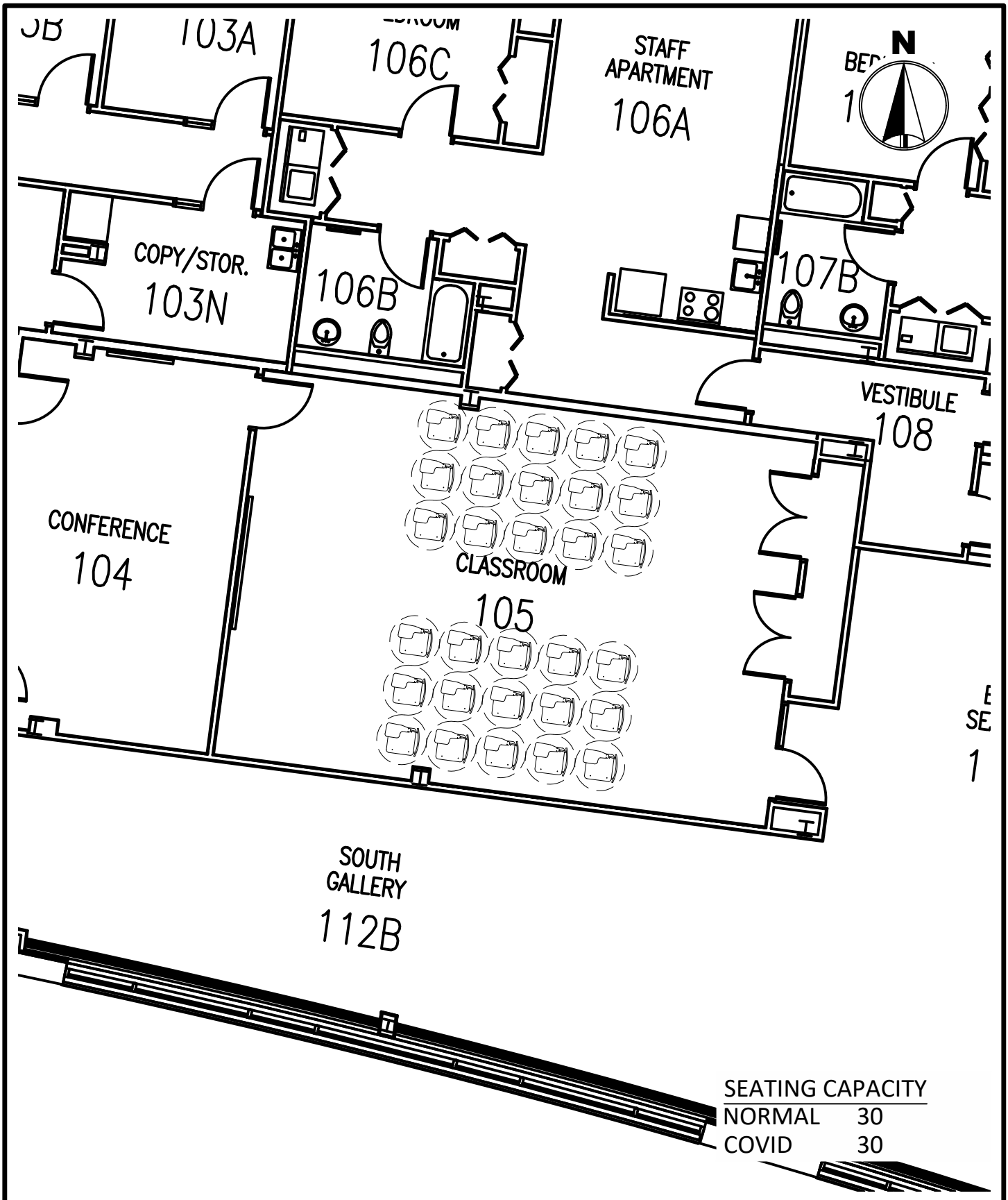

SEATING CAPACITY	
NORMAL	30
COVID	30



MINNESOTA STATE  
UNIVERSITY  
MANKATO  
PLANNING & CONSTRUCTION

PRESKA 105  
COVID SEATING LAYOUT  
6' SOCIAL DISTANCE

DRAWN BY: N. HUETTL

March 2021

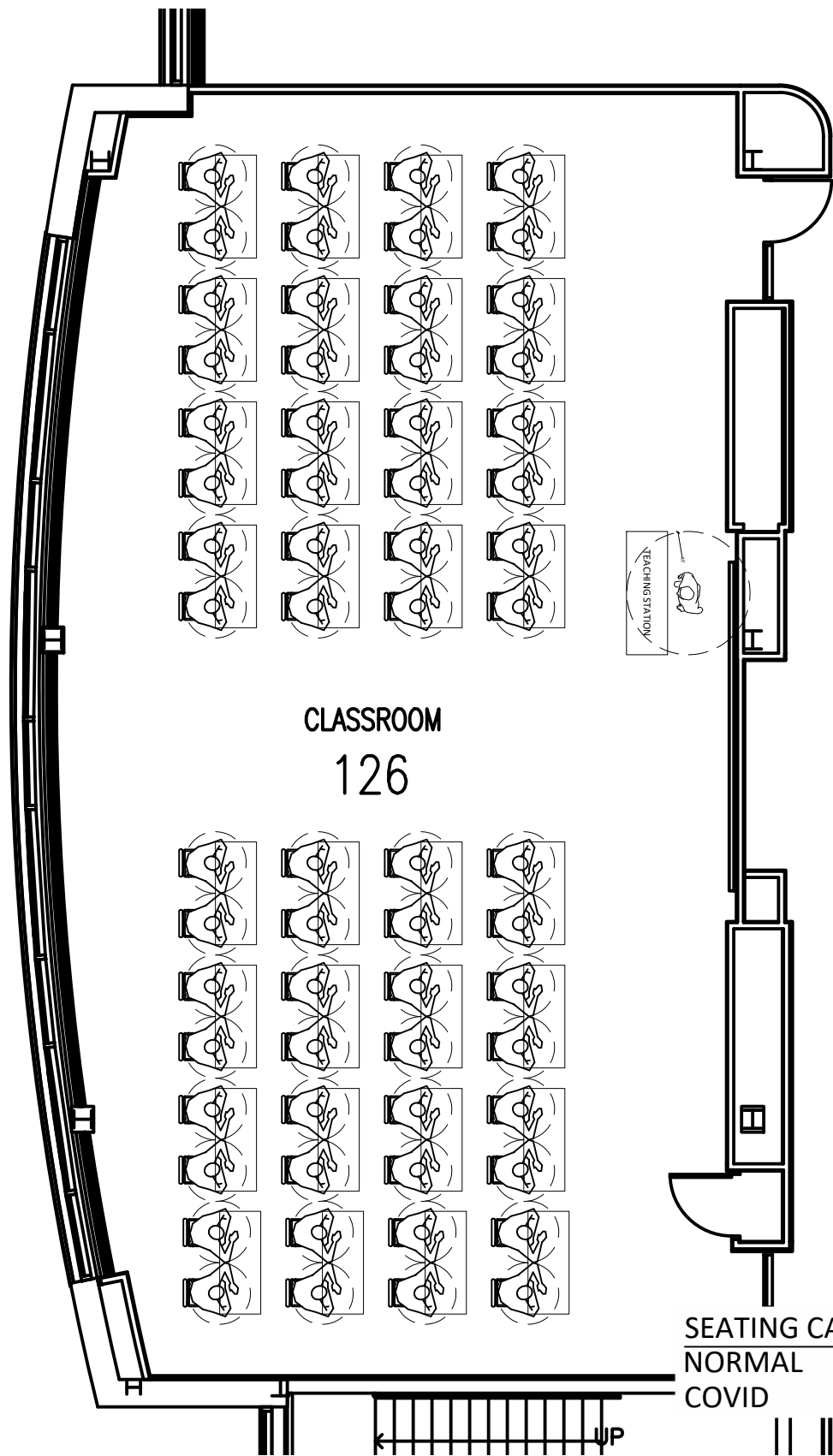
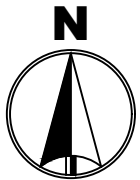

CLASSROOM  
126



SEATING CAPACITY	
NORMAL	80
COVID	66



MINNESOTA STATE  
UNIVERSITY  
MANKATO  
PLANNING & CONSTRUCTION

PRESKA 126  
COVID SEATING LAYOUT  
3' SOCIAL DISTANCE

DRAWN BY: N. HUETTL

March 2021

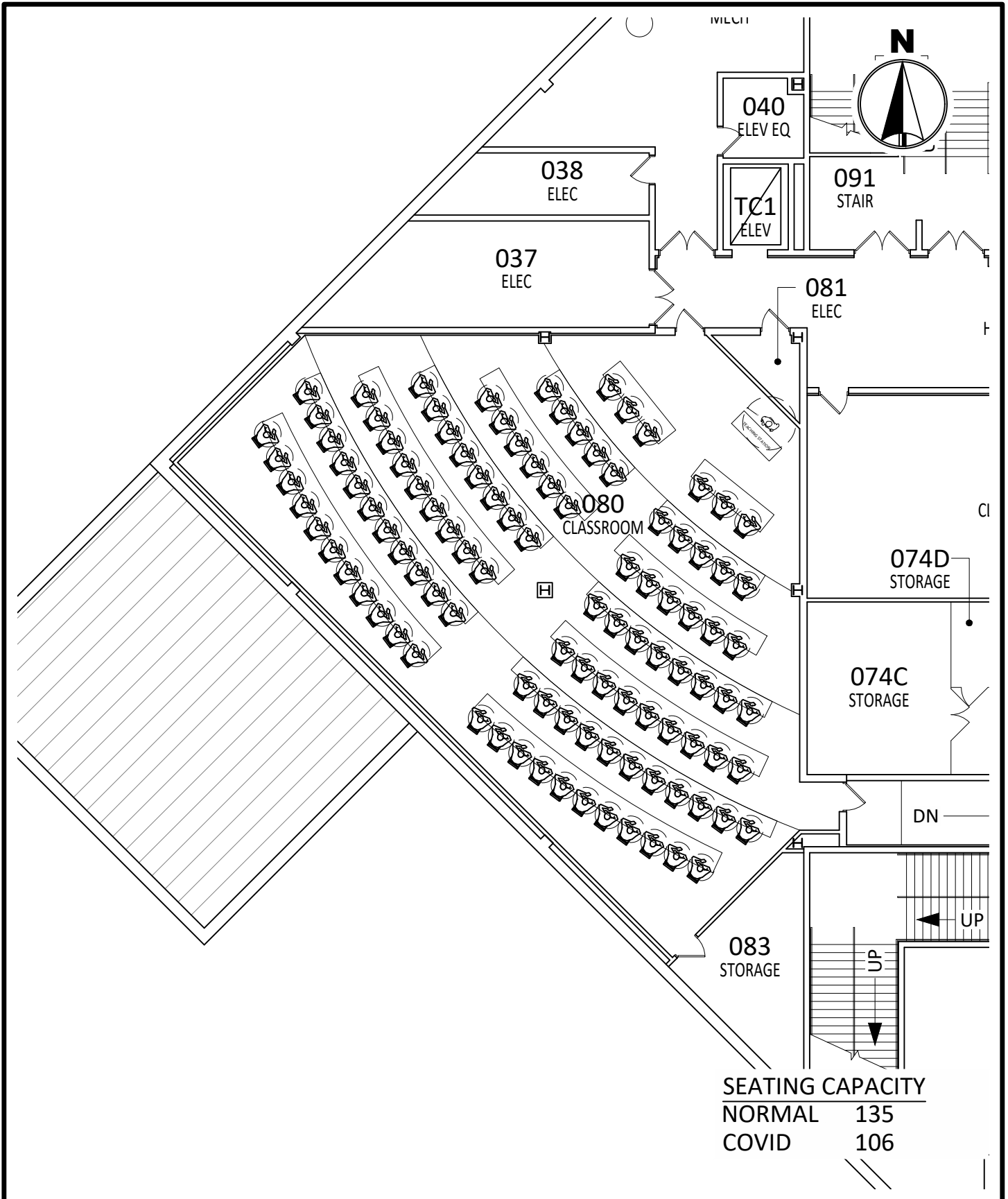

MINNESOTA STATE  
UNIVERSITY  
MANKATO  
PLANNING & CONSTRUCTION

TAYLOR CENTER 080  
COVID SEATING LAYOUT  
3' SOCIAL DISTANCE

DRAWN BY: N. HUETTL

March 2021



081  
ELEC

036  
HALLWAY

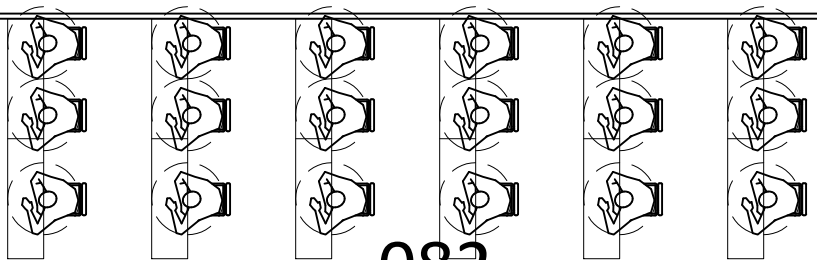

082  
CLASSROOM

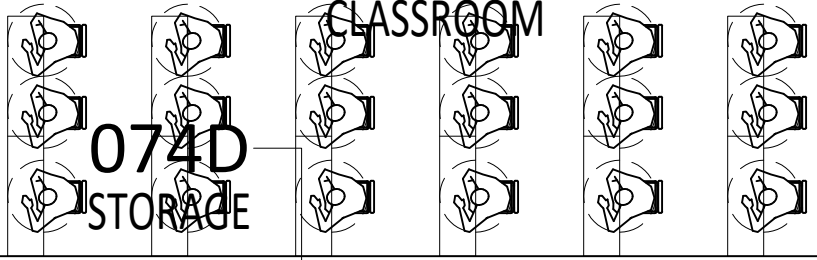

074D  
STORAGE

074A  
STORAGE

074C  
STORAGE

074B  
STORAGE

DN →

070A  
HALWAY

SEATING CAPACITY	
NORMAL	48
COVID	36

093



MINNESOTA STATE  
UNIVERSITY  
MANKATO

PLANNING & CONSTRUCTION

TAYLOR CENTER 082  
COVID SEATING LAYOUT  
3' SOCIAL DISTANCE

DRAWN BY: N. HUETTL

March 2021

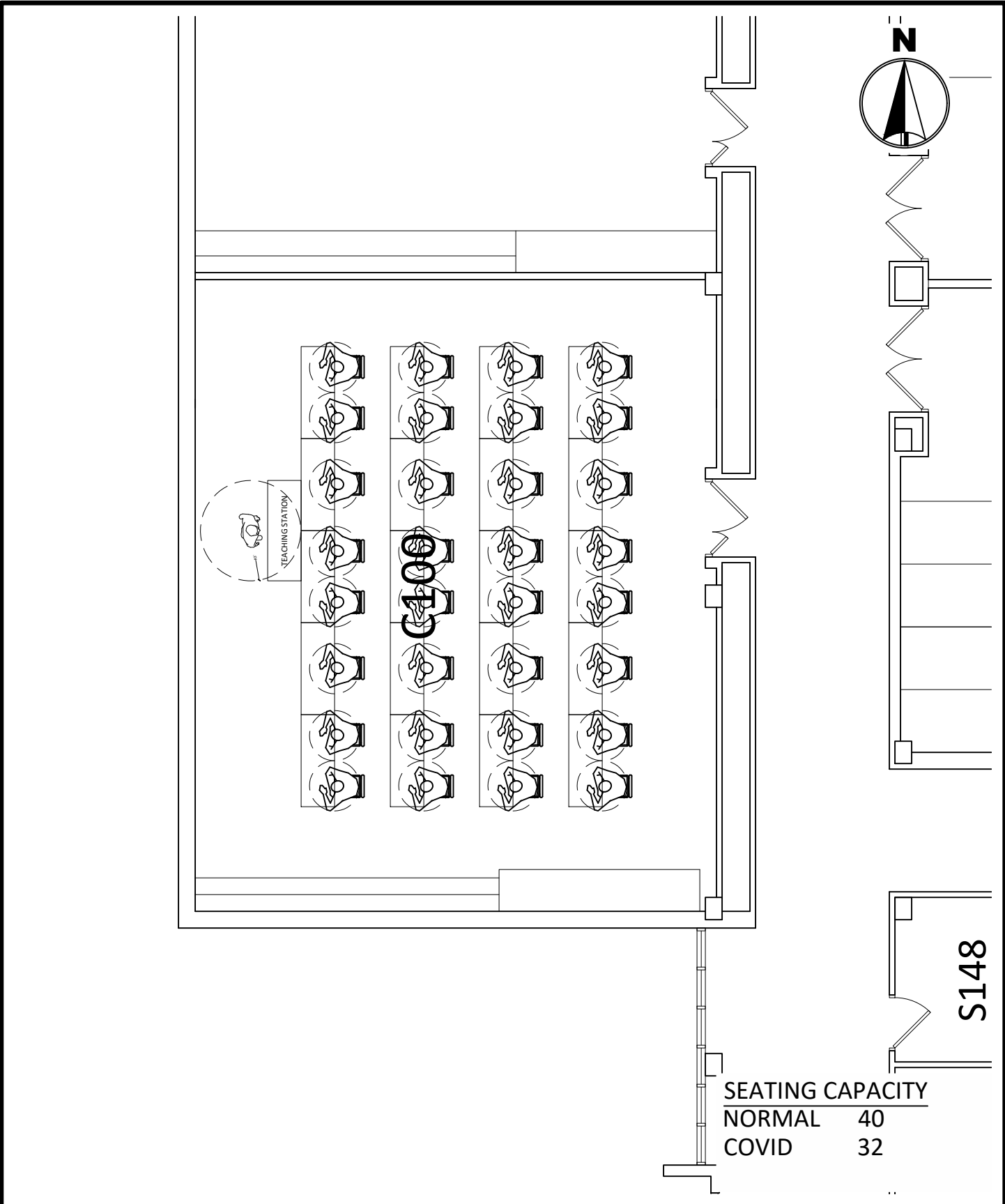

MINNESOTA STATE  
UNIVERSITY  
MANKATO  
PLANNING & CONSTRUCTION

TRAFTON CENTER C100  
COVID SEATING LAYOUT  
3' SOCIAL DISTANCE

DRAWN BY: N. HUETTL

March 2021

C1C C1C C1C C1C

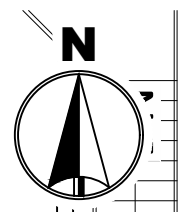
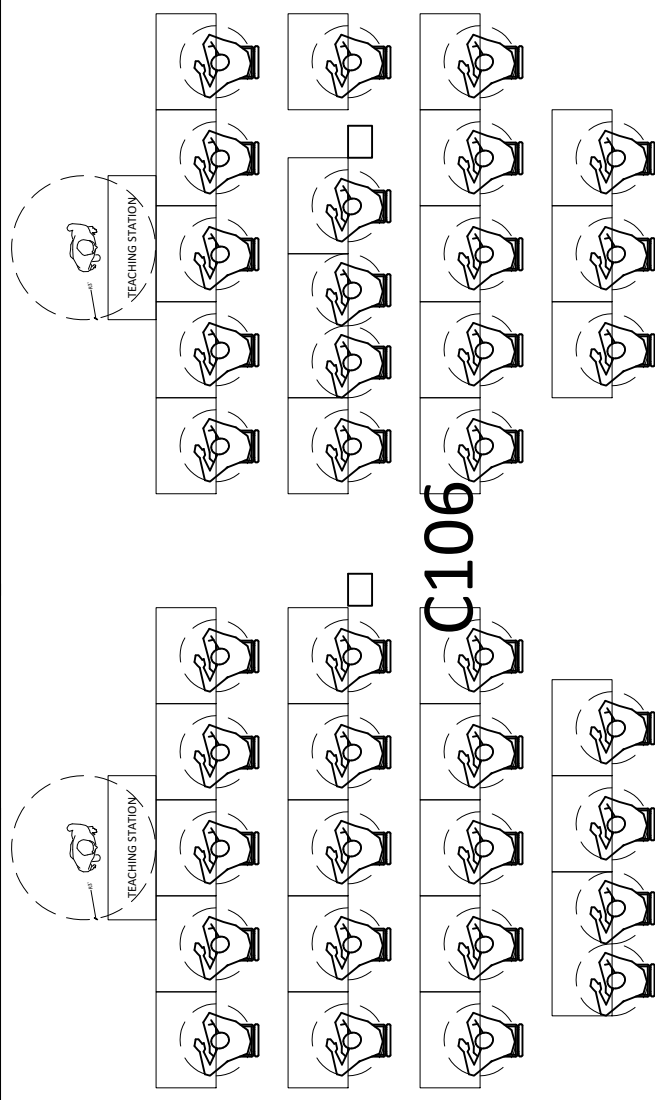

C1W

SEATING CAPACITY	
NORMAL	37
COVID	37



MINNESOTA STATE UNIVERSITY  
MANKATO  
PLANNING & CONSTRUCTION

TRAFTON CENTER C106  
COVID SEATING LAYOUT  
3' SOCIAL DISTANCE

DRAWN BY: N. HUETTL

March 2021

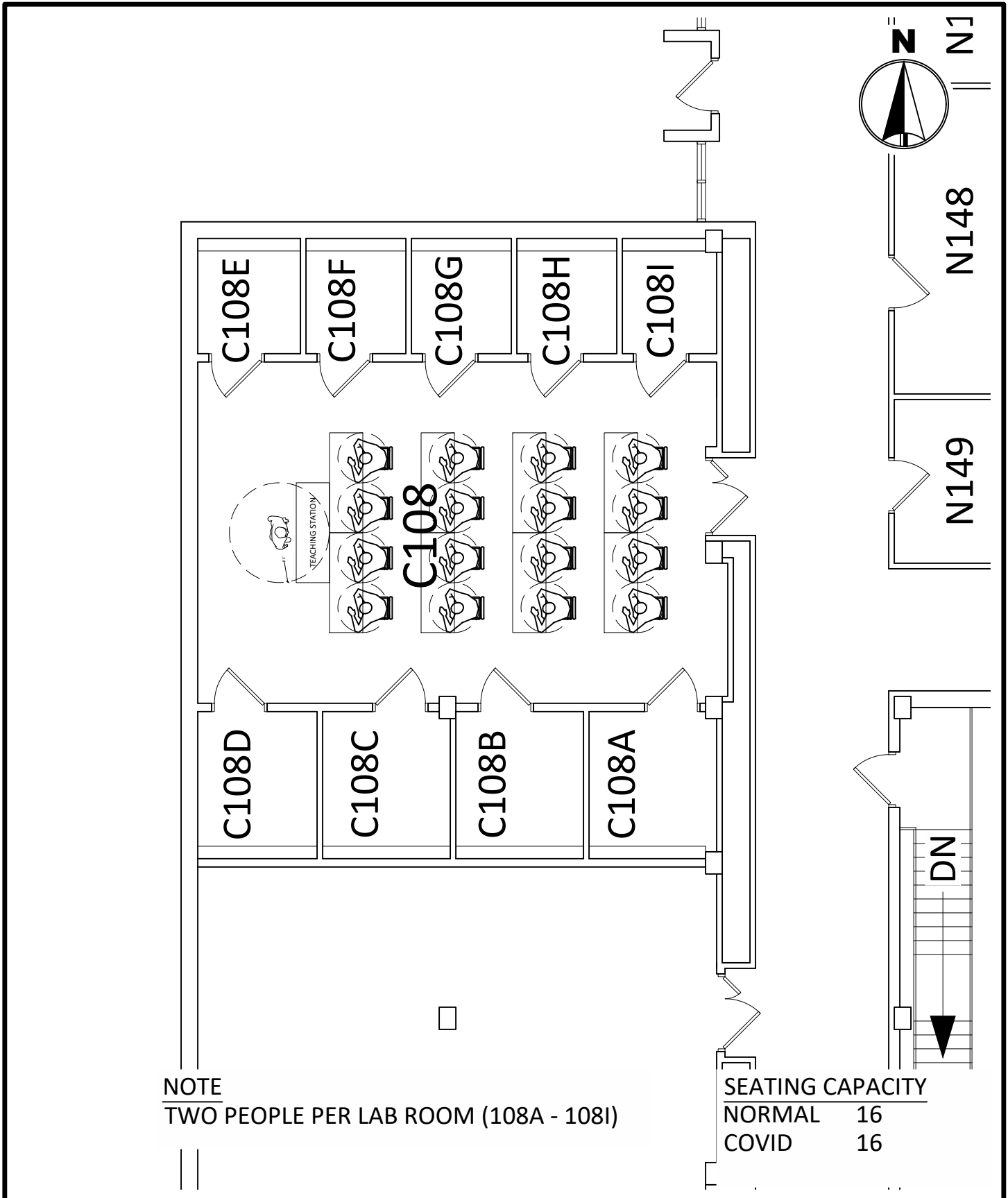

**NOTE**  
TWO PEOPLE PER LAB ROOM (108A - 108I)

SEATING CAPACITY	
NORMAL	16
COVID	16



**MINNESOTA STATE UNIVERSITY**  
MANKATO  
**PLANNING & CONSTRUCTION**

**TRAFTON CENTER C108**  
COVID SEATING LAYOUT  
3' SOCIAL DISTANCE

DRAWN BY: N. HUETTL March 2021

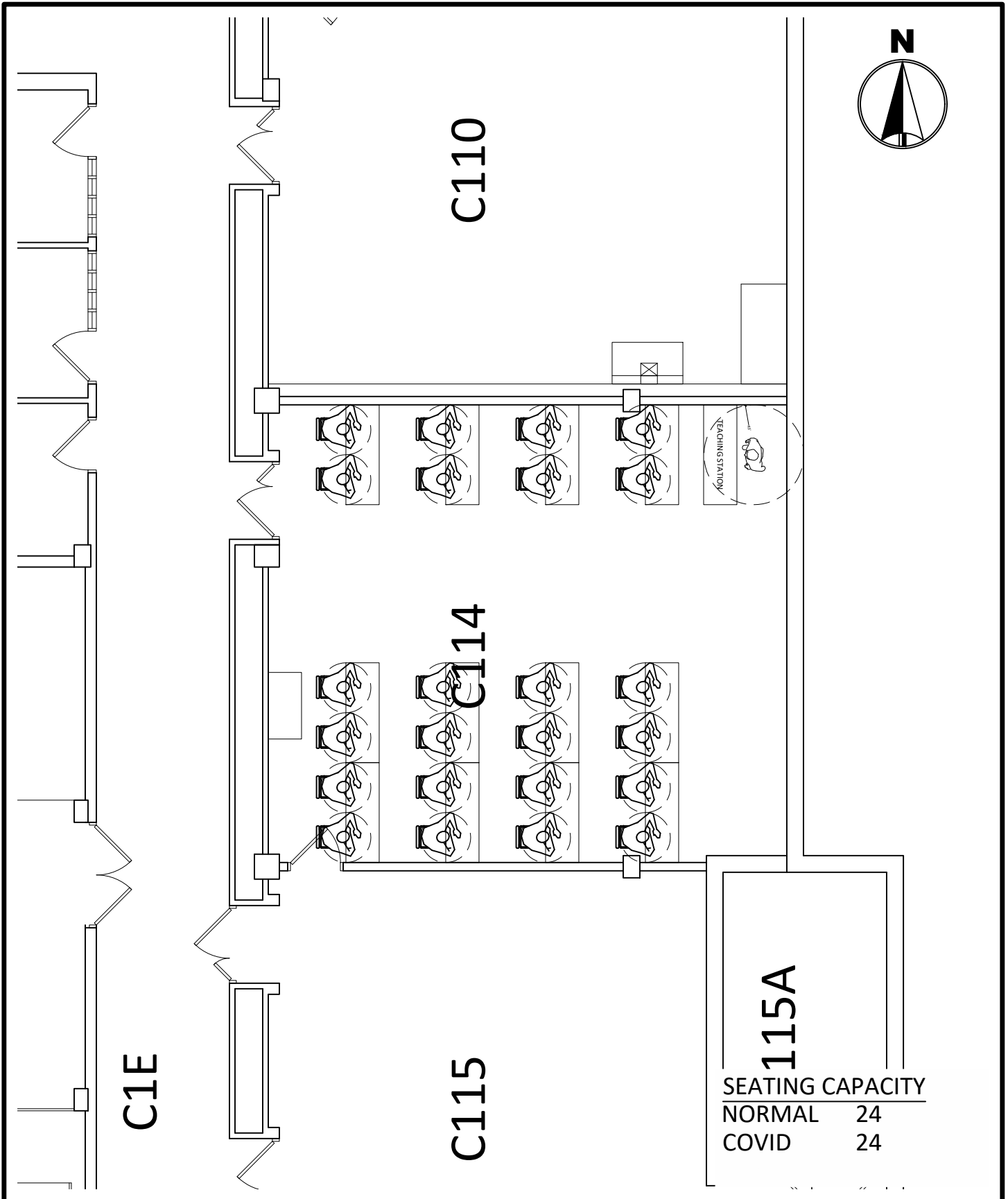

<b>115A</b>	
SEATING CAPACITY	
NORMAL	24
COVID	24



**MINNESOTA STATE UNIVERSITY**  
MANKATO  
PLANNING & CONSTRUCTION

**TRAFTON CENTER C114**  
COVID SEATING LAYOUT  
3' SOCIAL DISTANCE

DRAWN BY: N. HUETTL

March 2021

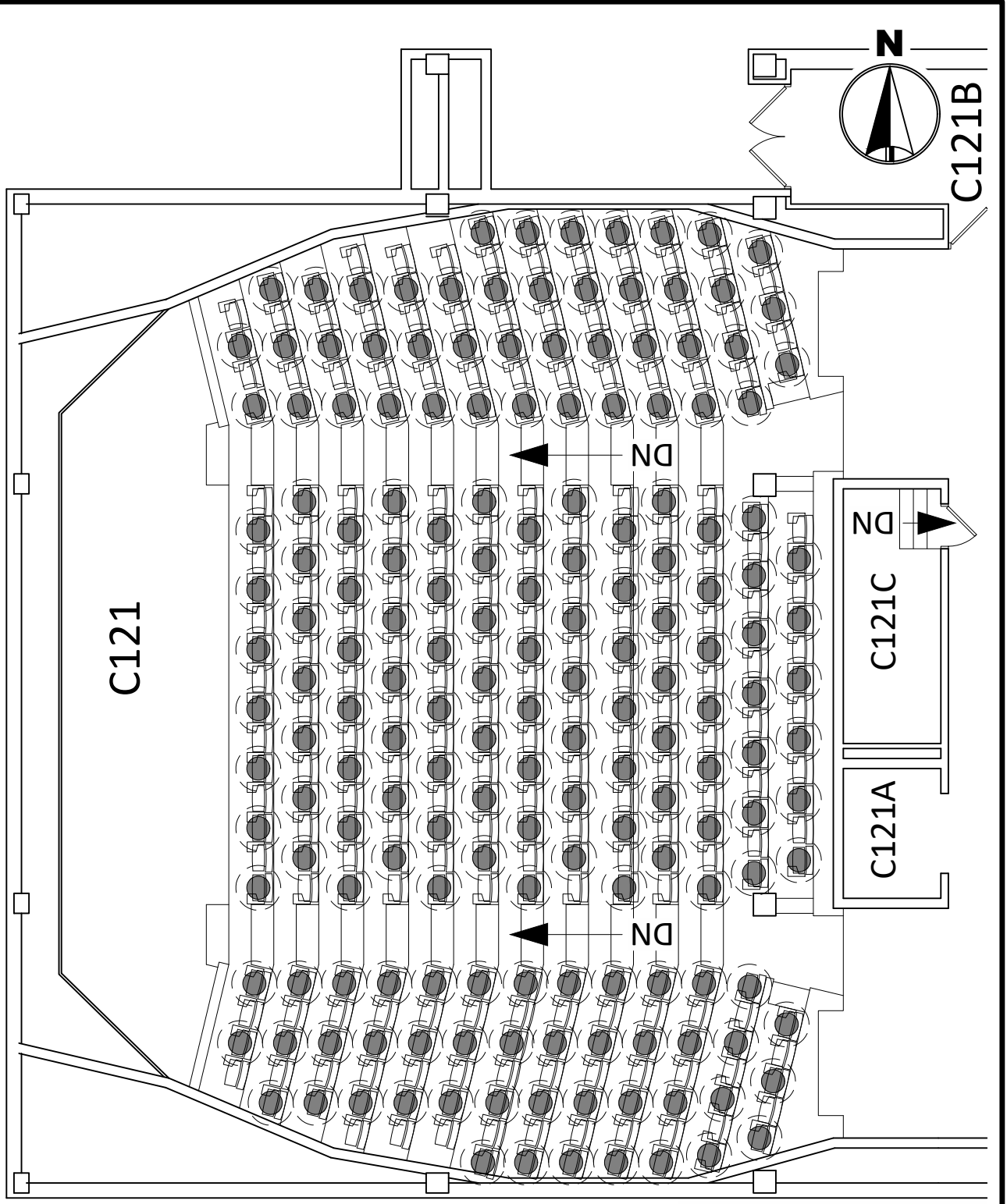

SEATING CAPACITY	
NORMAL	339
COVID	178



MINNESOTA STATE  
UNIVERSITY  
MANKATO  
PLANNING & CONSTRUCTION

TRAFTON CENTER C121  
COVID SEATING LAYOUT  
3' SOCIAL DISTANCE

DRAWN BY: N. HUETTL

March 2021

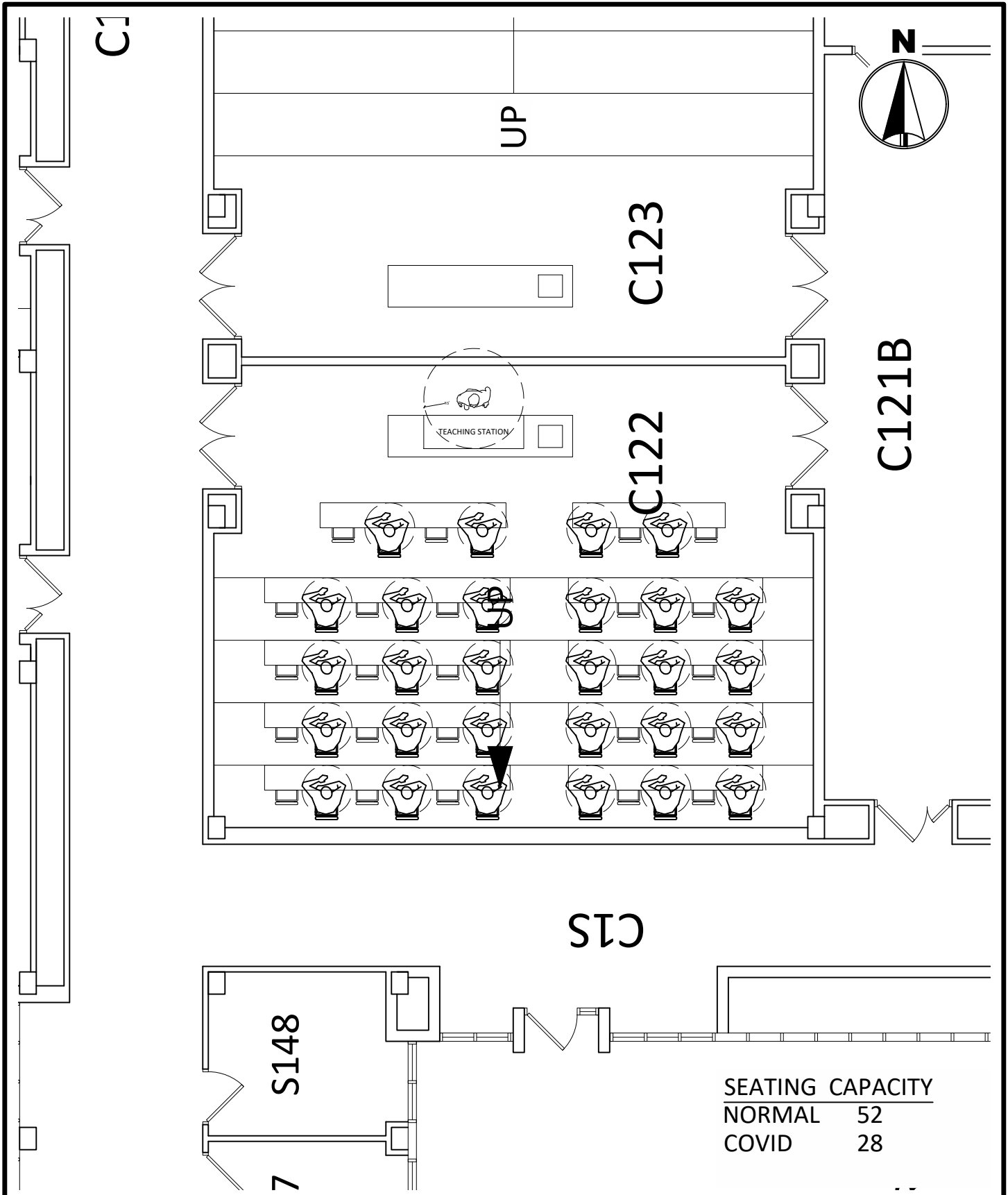

MINNESOTA STATE  
UNIVERSITY  
MANKATO  
PLANNING & CONSTRUCTION

TRAFTON CENTER C122  
COVID SEATING LAYOUT  
3' SOCIAL DISTANCE

DRAWN BY: N. HUETTL

March 2021

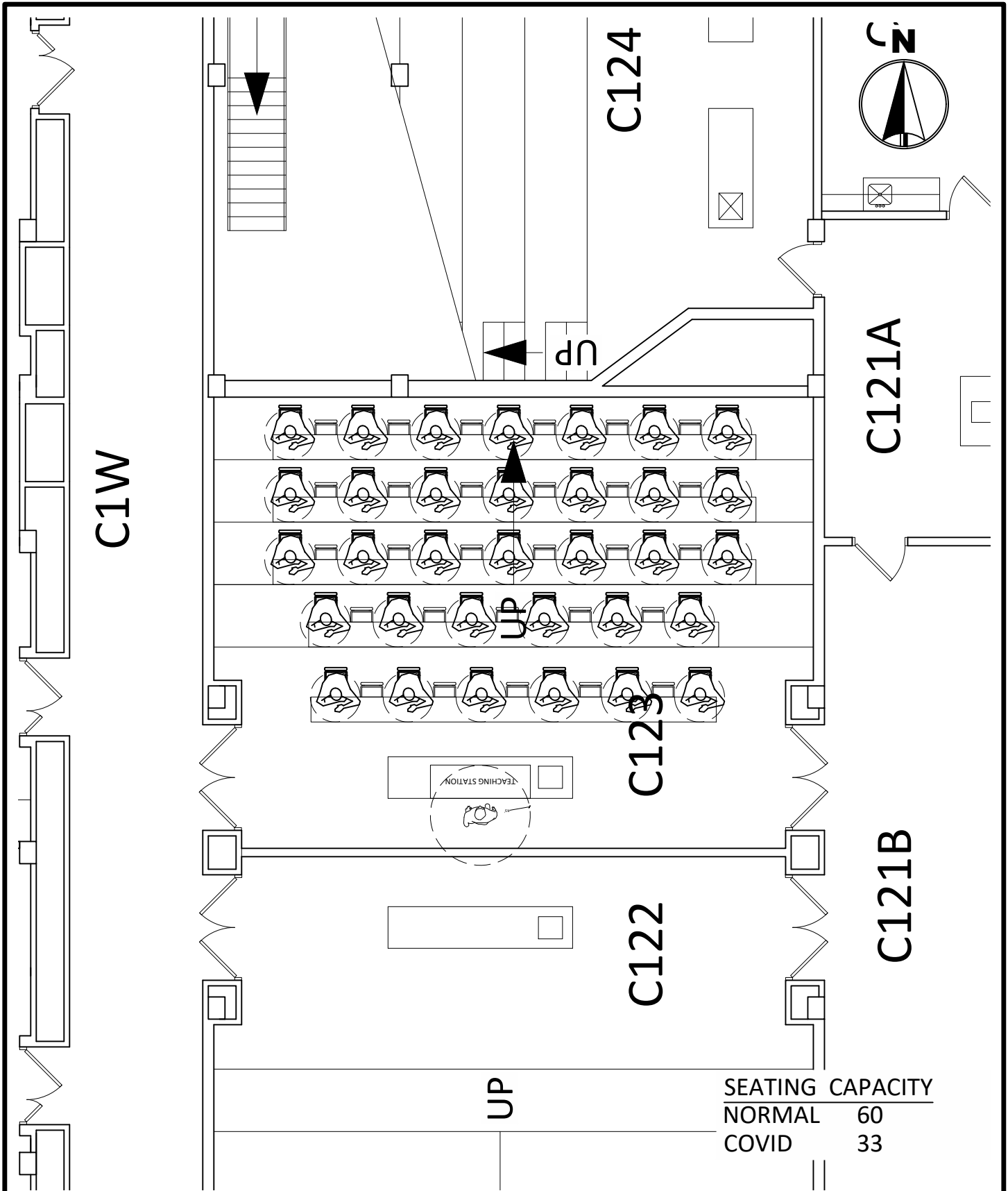

C1W

C124



C121A

UP

UP

C123

TEACHING STATION

C121B

C122

UP

SEATING CAPACITY	
NORMAL	60
COVID	33



MINNESOTA STATE UNIVERSITY  
MANKATO  
PLANNING & CONSTRUCTION

TRAFTON CENTER C123  
COVID SEATING LAYOUT  
3' SOCIAL DISTANCE

DRAWN BY: N. HUETTL

March 2021



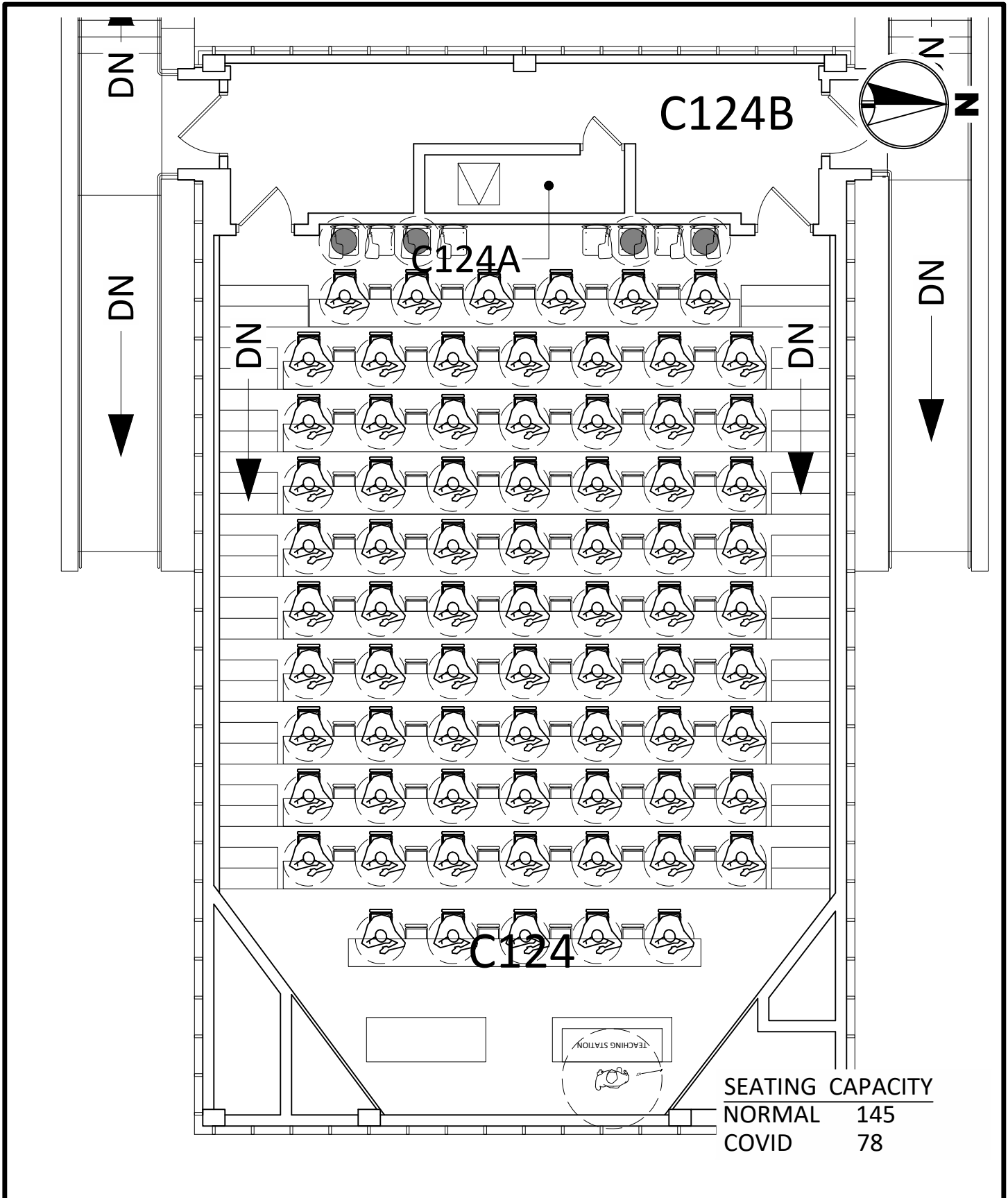

SEATING CAPACITY	
NORMAL	145
COVID	78



**MINNESOTA STATE UNIVERSITY**  
MANKATO  
**PLANNING & CONSTRUCTION**

**TRAFTON CENTER C124**  
COVID SEATING LAYOUT  
3' SOCIAL DISTANCE

DRAWN BY: N. HUETTL March 2021

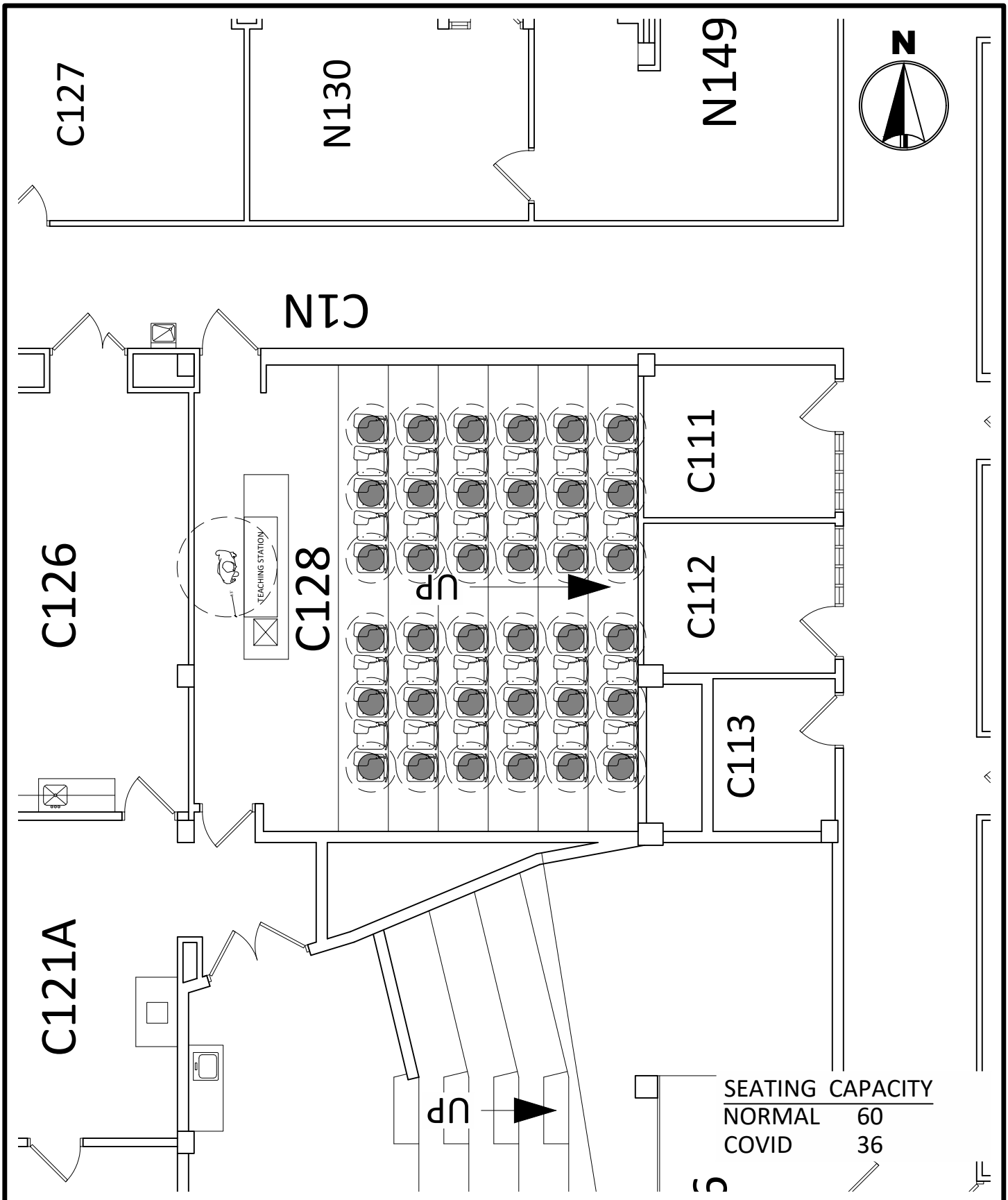

**MINNESOTA STATE UNIVERSITY**  
 MANKATO  
**PLANNING & CONSTRUCTION**

**TRAFTON CENTER C128**  
 COVID SEATING LAYOUT  
 3' SOCIAL DISTANCE

DRAWN BY: N. HUETTL  
 March 2021

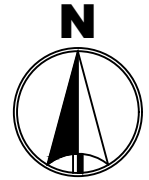

N331

N330

C309

C308

C310

C312

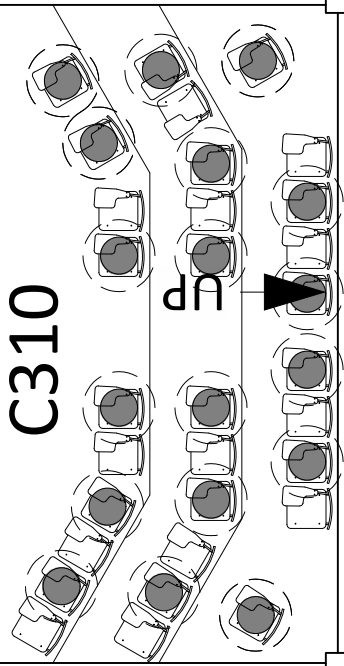
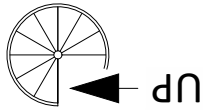
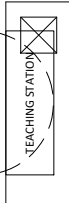

NOTE  
4 TABLET ARM CHAIRS ADDED  
TO INCREASE CAPACITY

SEATING CAPACITY	
NORMAL	34
COVID	18



MINNESOTA STATE  
UNIVERSITY  
MANKATO  
PLANNING & CONSTRUCTION

TRAFTON CENTER 310  
COVID SEATING LAYOUT  
3' SOCIAL DISTANCE

DRAWN BY: N. HUETTL

March 2021

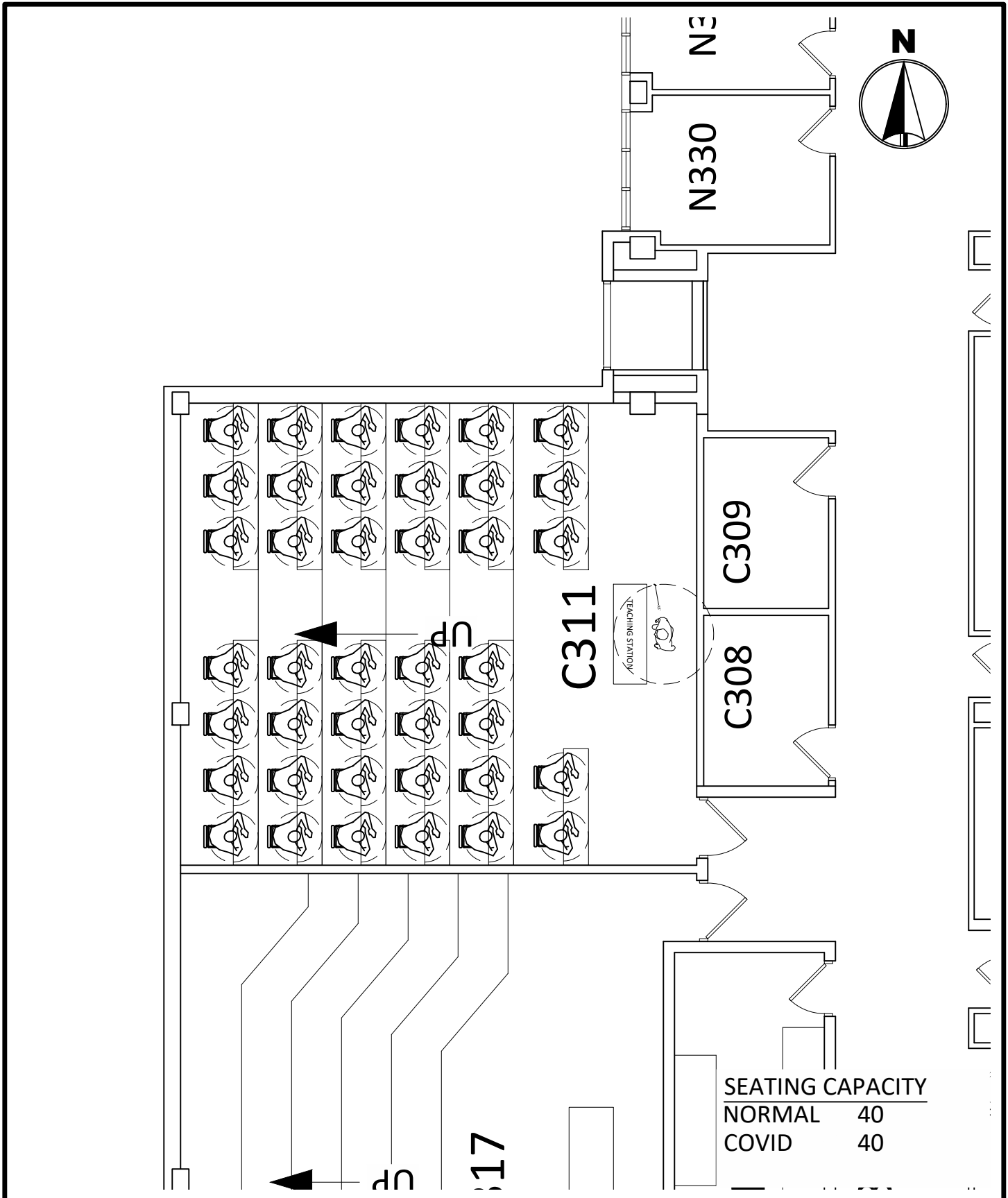

SEATING CAPACITY	
NORMAL	40
COVID	40



**MINNESOTA STATE UNIVERSITY**  
MANKATO  
PLANNING & CONSTRUCTION

**TRAFTON CENTER 311**  
COVID SEATING LAYOUT  
3' SOCIAL DISTANCE

DRAWN BY: N. HUETTL March 2021

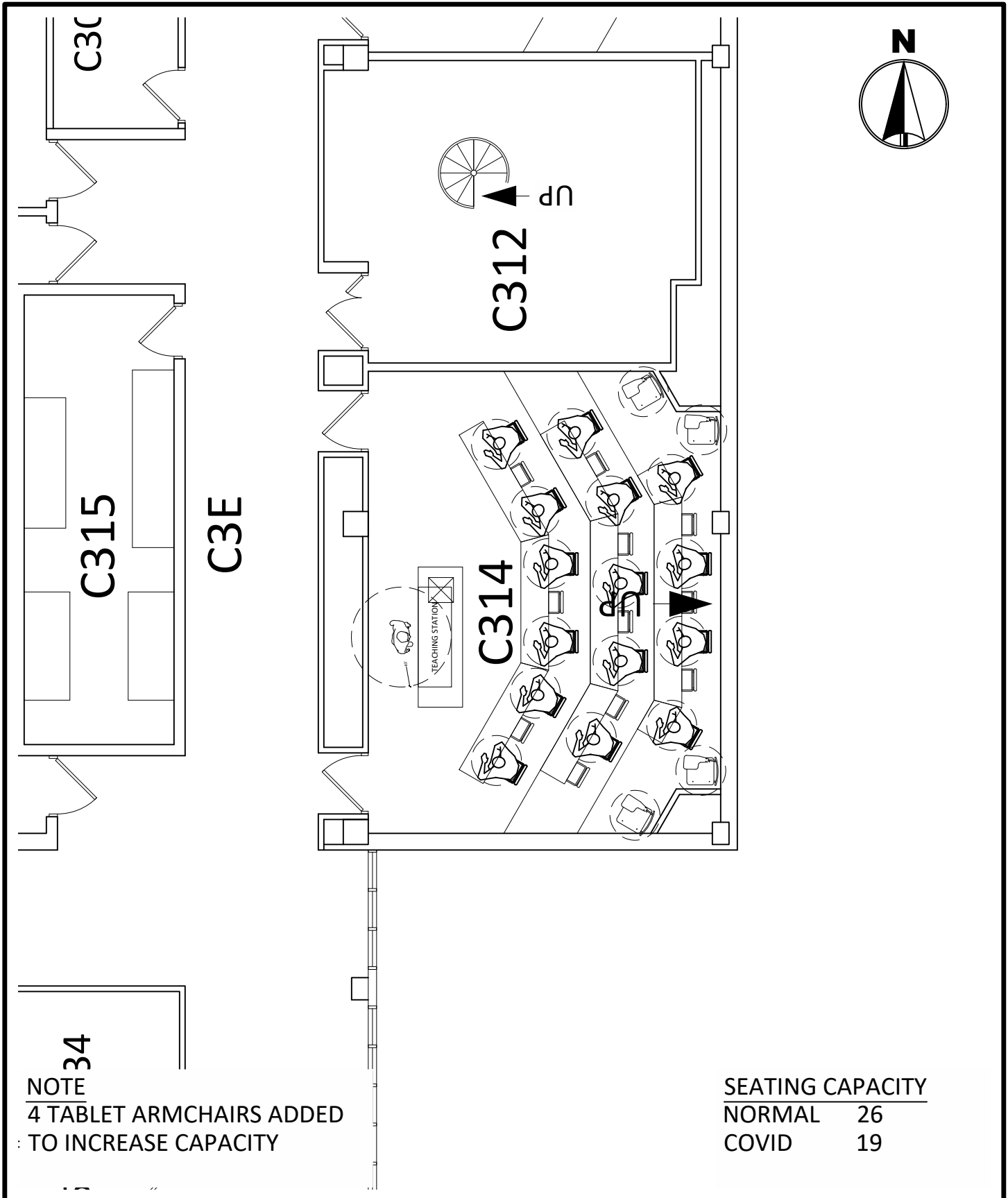

NOTE 34  
 4 TABLET ARMCHAIRS ADDED  
 TO INCREASE CAPACITY

SEATING CAPACITY	
NORMAL	26
COVID	19



MINNESOTA STATE  
 UNIVERSITY  
 MANKATO  
 PLANNING & CONSTRUCTION

TRAFTON CENTER 314  
 COVID SEATING LAYOUT  
 3' SOCIAL DISTANCE

DRAWN BY: N. HUETTL March 2021

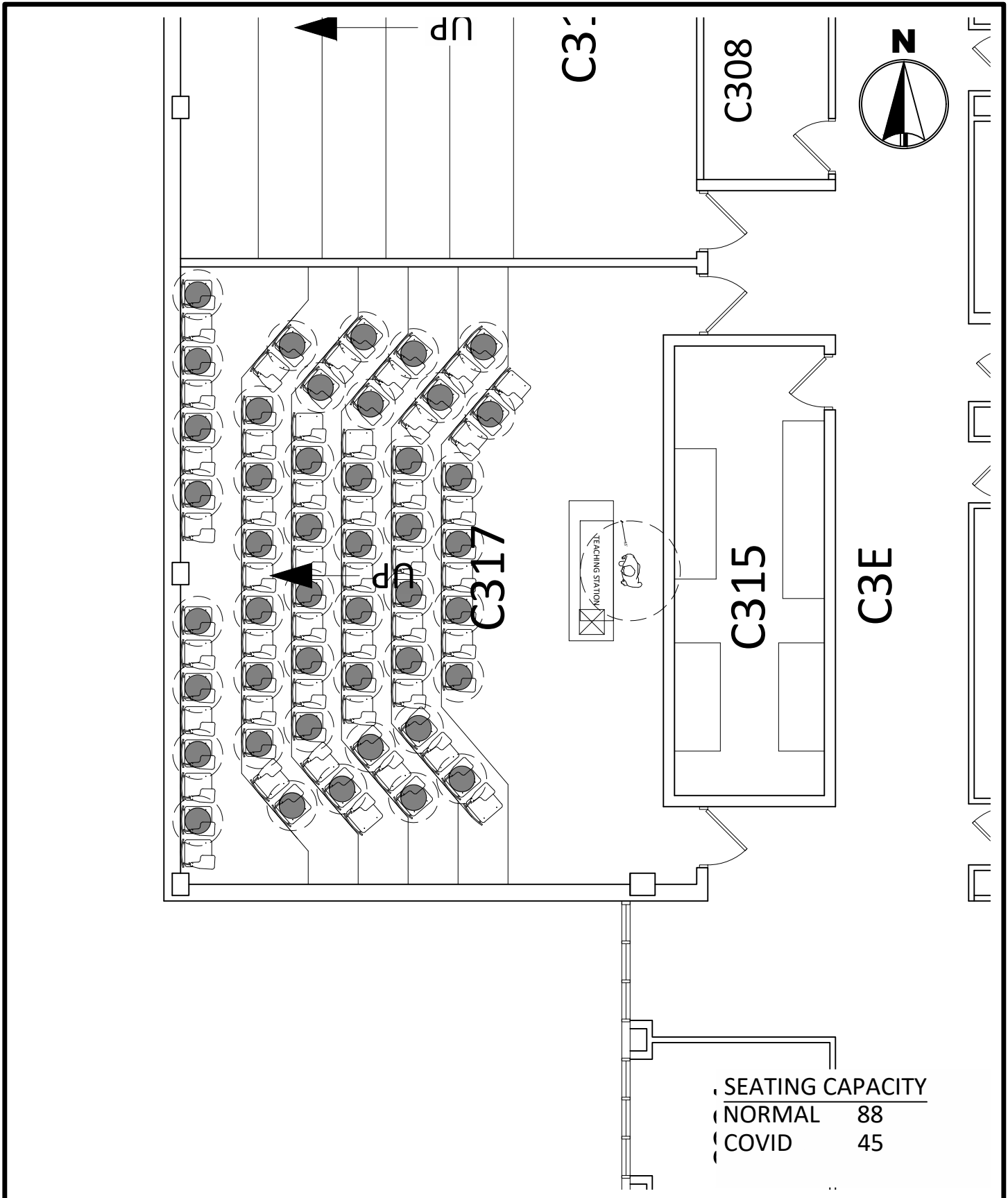

MINNESOTA STATE  
UNIVERSITY  
MANKATO  
PLANNING & CONSTRUCTION

TRAFTON CENTER 317  
COVID SEATING LAYOUT  
3' SOCIAL DISTANCE

DRAWN BY: N. HUETTL

March 2021

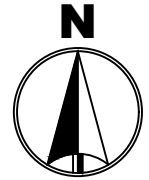

TEACHING STATION

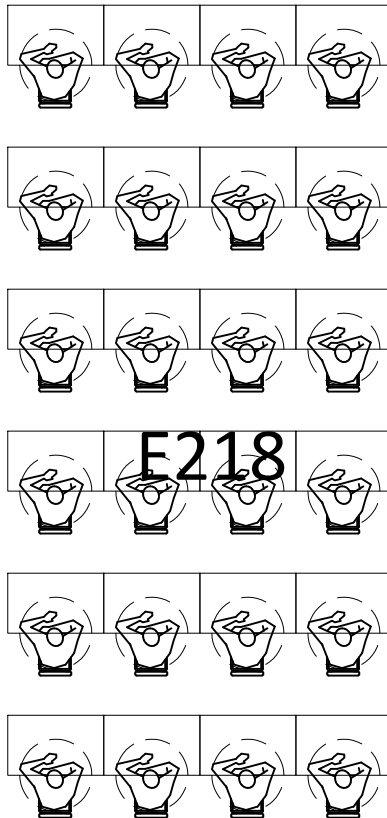

E219

E217

E233

SEATING CAPACITY	
NORMAL	24
COVID	24

E187



MINNESOTA STATE UNIVERSITY  
MANKATO  
PLANNING & CONSTRUCTION

TRAFTON EAST 218  
COVID SEATING LAYOUT  
3' SOCIAL DISTANCE

DRAWN BY: N. HUETTL

March 2021

E235



E222

TEACHING STATION

E224

E225

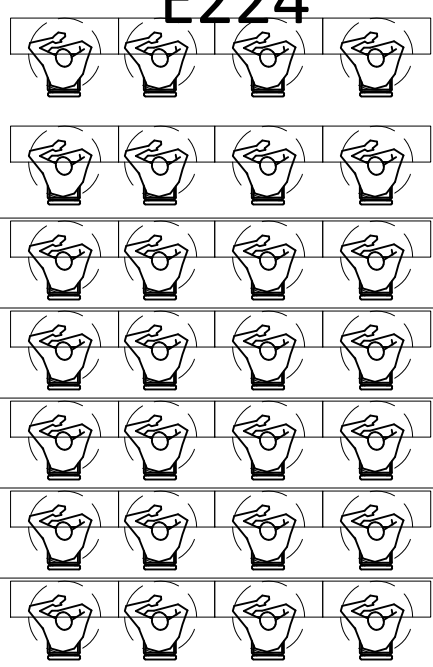

SEATING CAPACITY	
NORMAL	55
COVID	14



**MINNESOTA STATE UNIVERSITY**  
MANKATO  
PLANNING & CONSTRUCTION

**TRAFTON EAST 224**  
COVID SEATING LAYOUT  
3' SOCIAL DISTANCE

DRAWN BY: N. HUETTL

March 2021



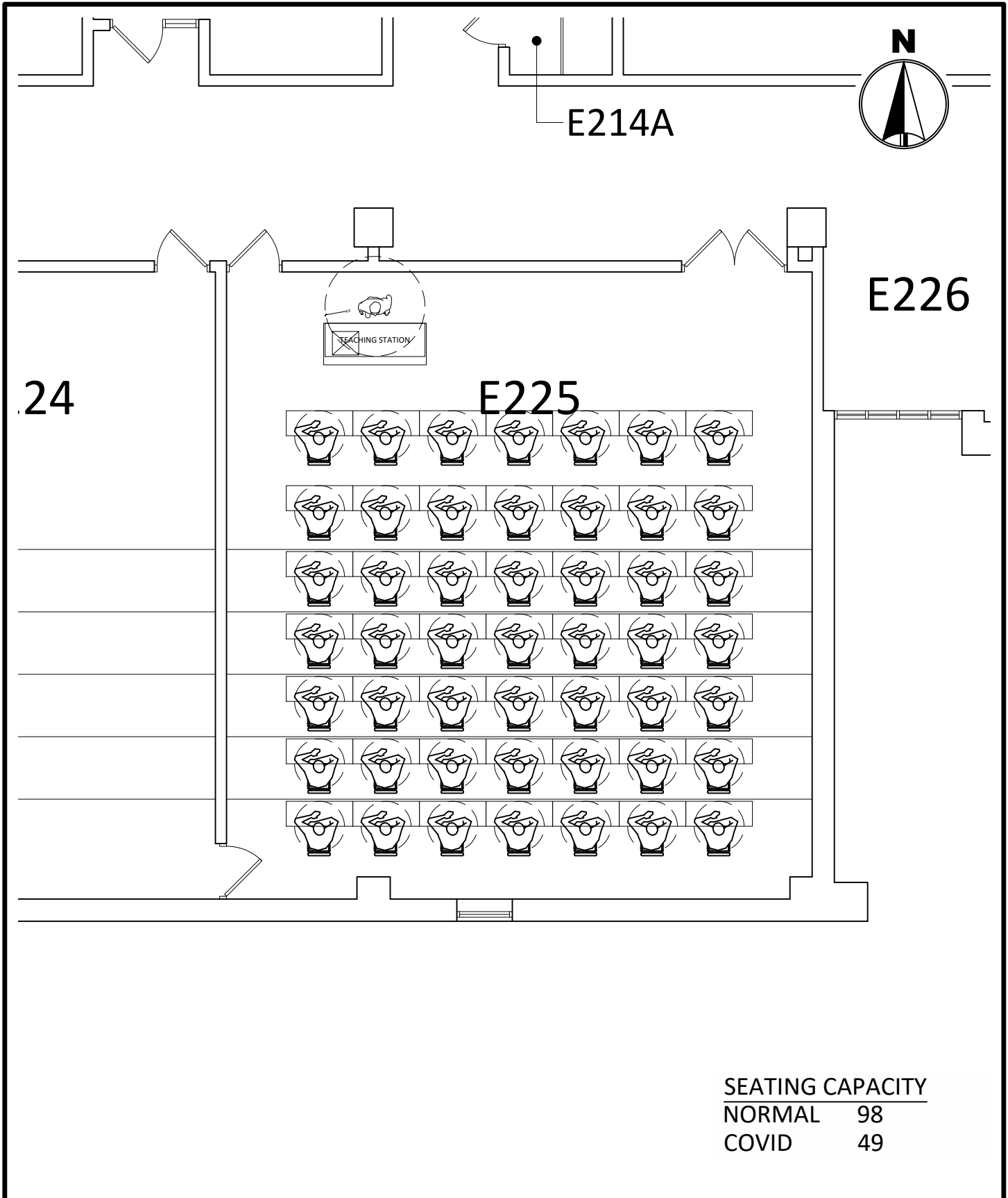

SEATING CAPACITY	
NORMAL	98
COVID	49



**MINNESOTA STATE UNIVERSITY**  
MANKATO  
**PLANNING & CONSTRUCTION**

**TRAFTON EAST 225**  
COVID SEATING LAYOUT  
3' SOCIAL DISTANCE

DRAWN BY: N. HUETTL

March 2021

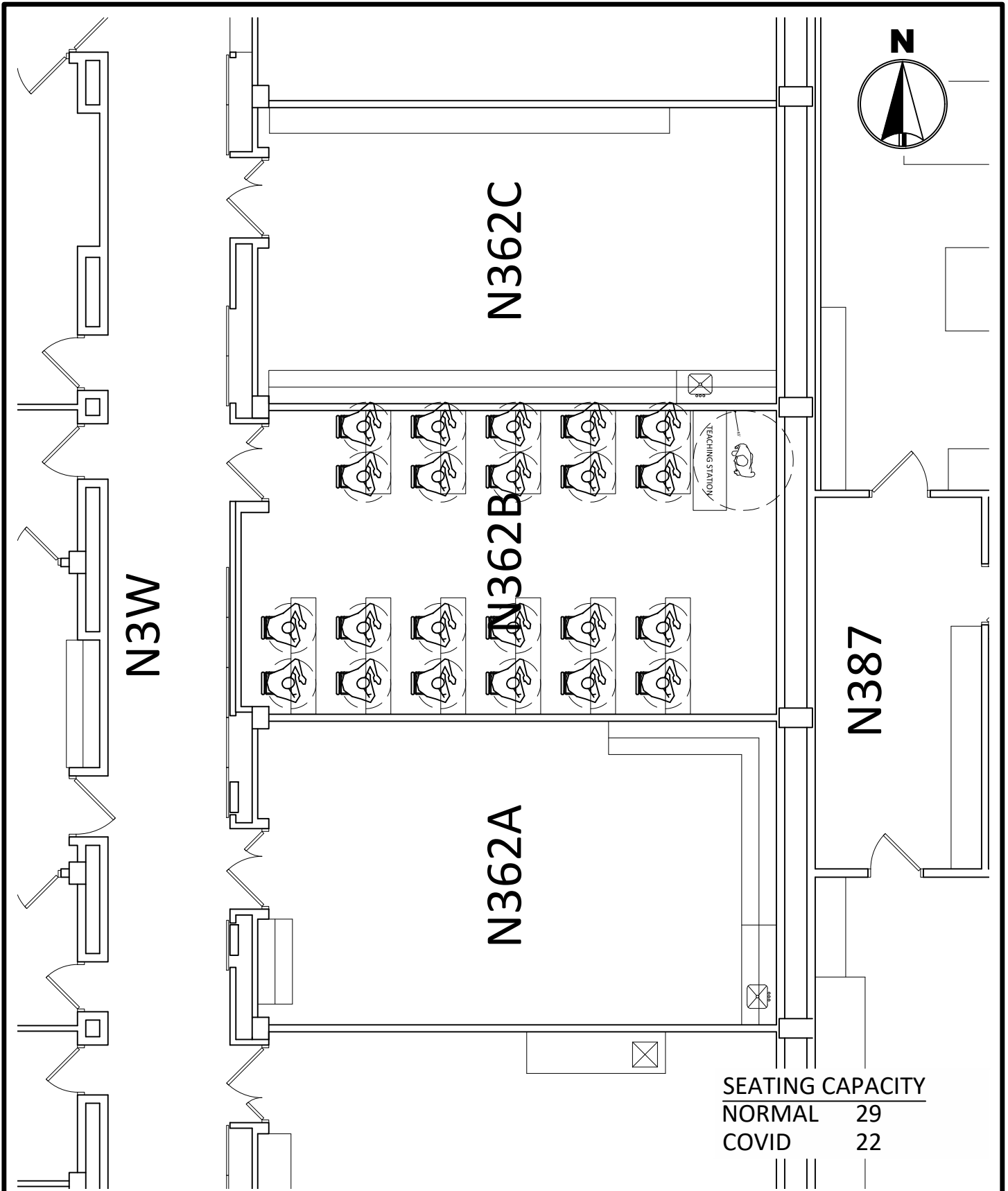

SEATING CAPACITY	
NORMAL	29
COVID	22



MINNESOTA STATE  
UNIVERSITY  
MANKATO  
PLANNING & CONSTRUCTION

TRAFTON NORTH 362B  
COVID SEATING LAYOUT  
3' SOCIAL DISTANCE

DRAWN BY: N. HUETTL

March 2021

N362C



N363

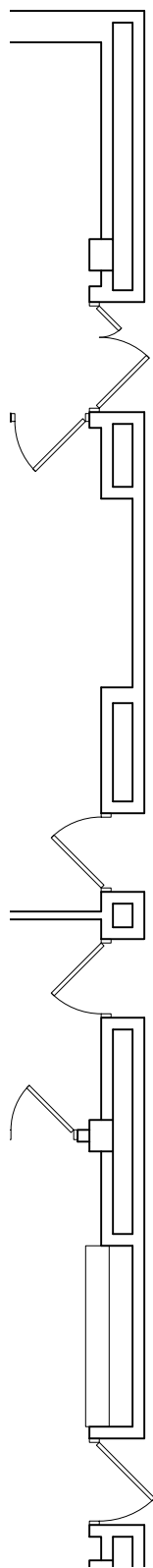

N3N

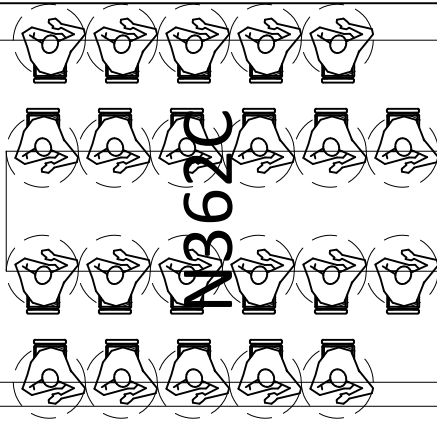

N362B

N2A

N387

SEATING CAPACITY	
NORMAL	22
COVID	22



MINNESOTA STATE UNIVERSITY  
MANKATO

PLANNING & CONSTRUCTION

TRAFTON NORTH 362C  
COVID SEATING LAYOUT  
3' SOCIAL DISTANCE

DRAWN BY: N. HUETTL

March 2021

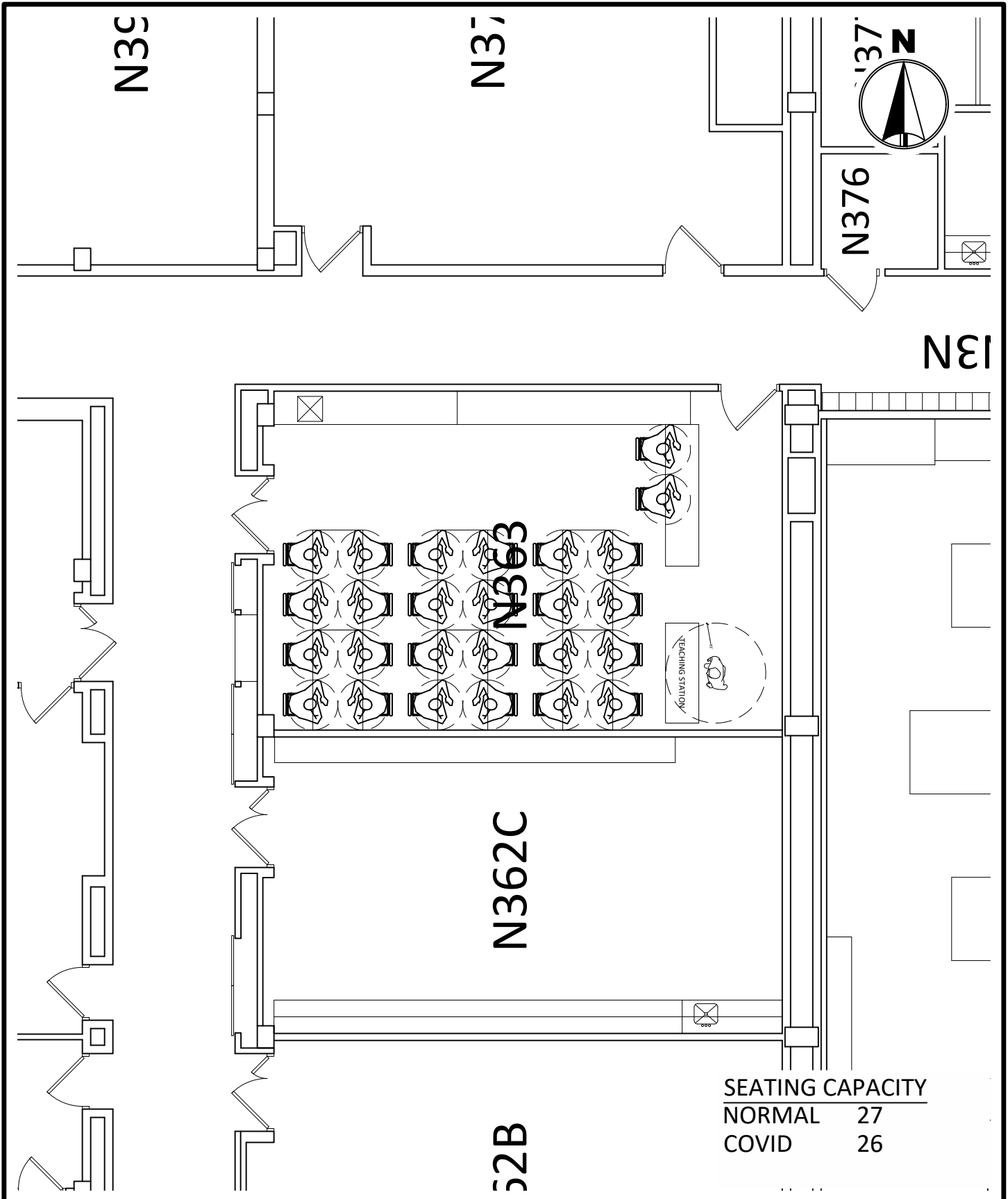

SEATING CAPACITY	
NORMAL	27
COVID	26



MINNESOTA STATE  
UNIVERSITY  
MANKATO  
PLANNING & CONSTRUCTION

TRAFTON NORTH 363  
COVID SEATING LAYOUT  
3' SOCIAL DISTANCE

DRAWN BY: N. HUETTL

March 2021

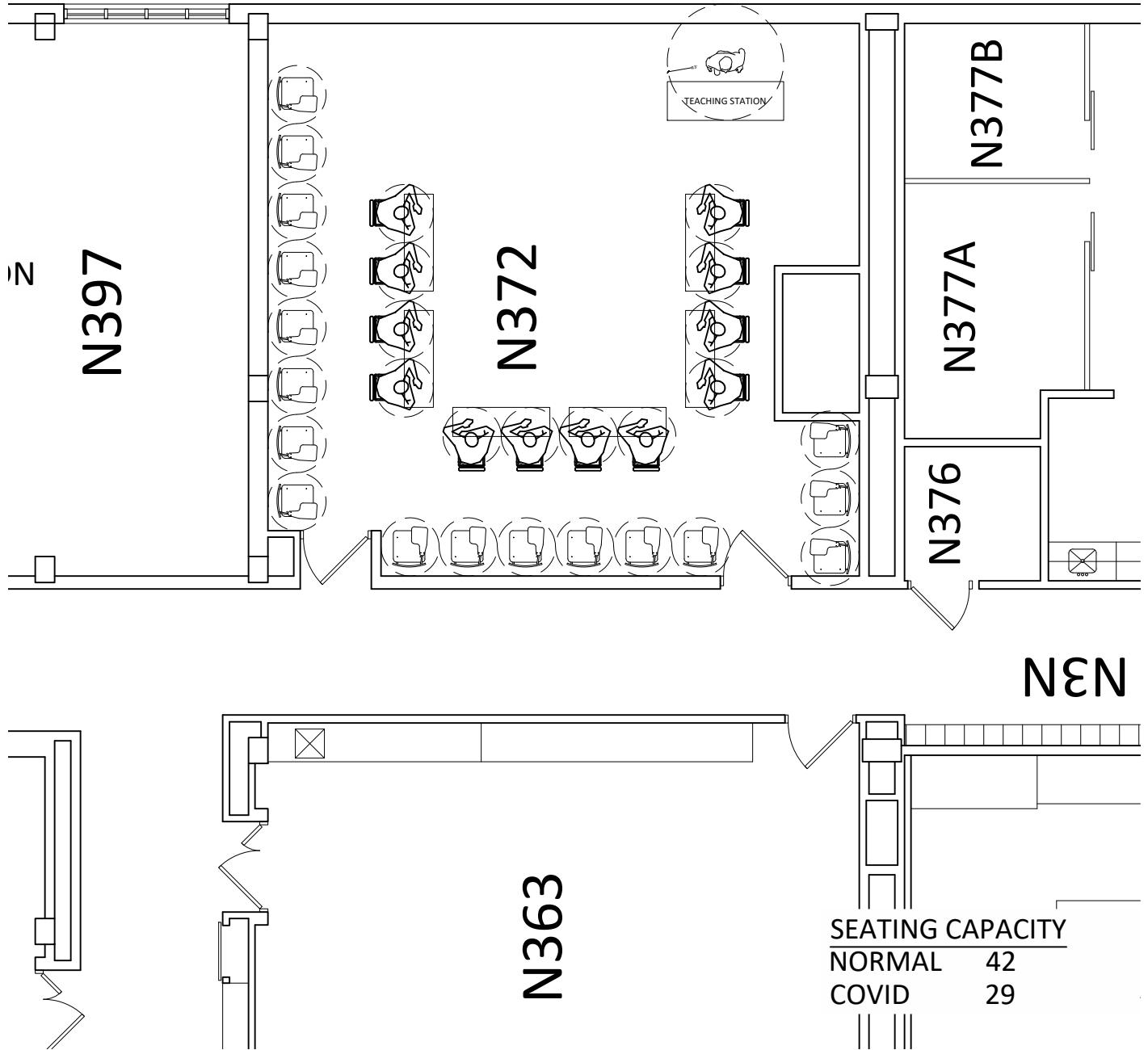
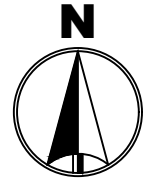

SEATING CAPACITY	
NORMAL	42
COVID	29



MINNESOTA STATE  
UNIVERSITY  
MANKATO  
PLANNING & CONSTRUCTION

TRAFTON NORTH 372  
COVID SEATING LAYOUT  
3' SOCIAL DISTANCE

DRAWN BY: N. HUETTL

March 2021

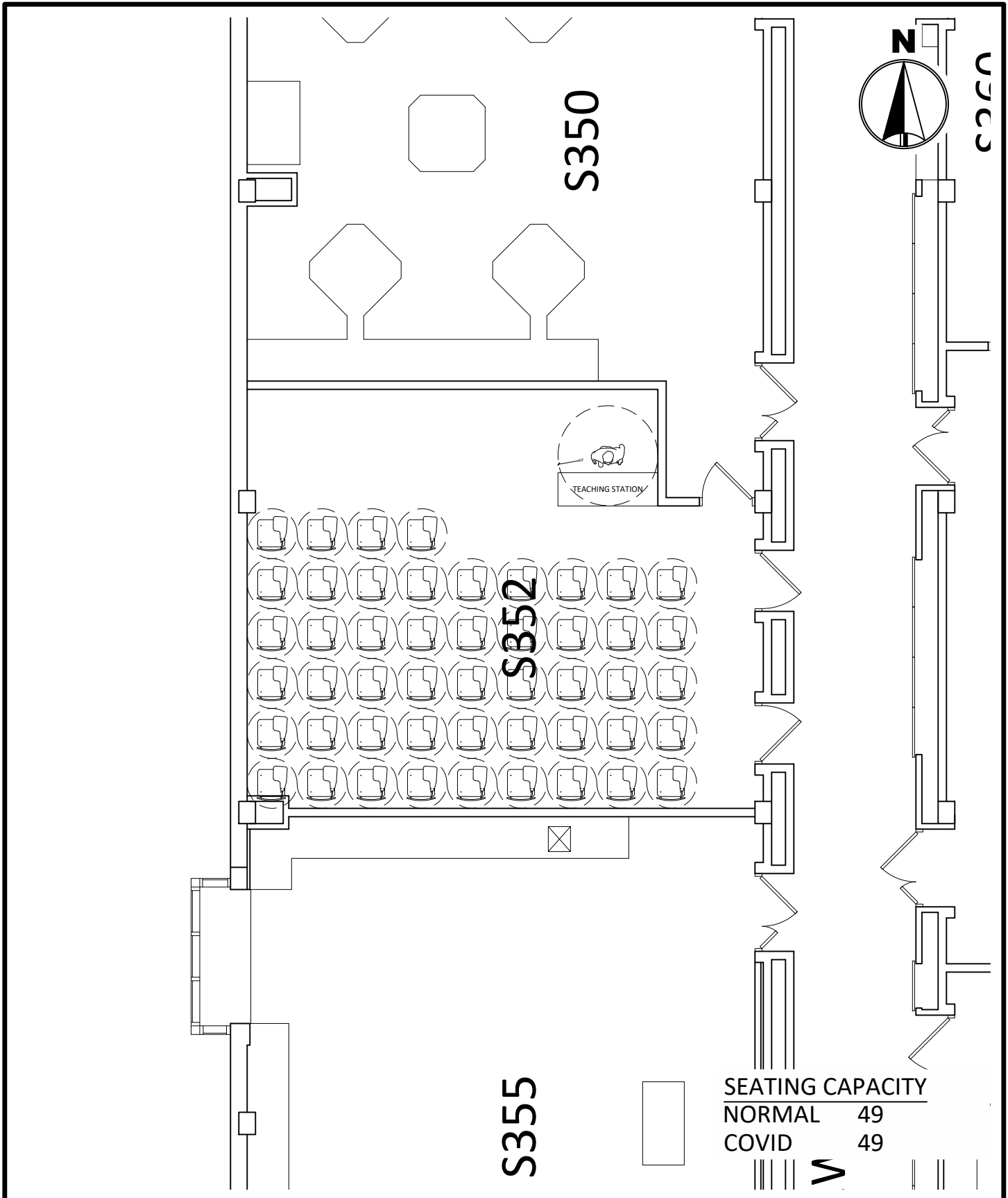

S355

S350

SB52

SEATING CAPACITY  
 NORMAL 49  
 COVID 49



MINNESOTA STATE UNIVERSITY  
 MANKATO  
 PLANNING & CONSTRUCTION

TRAFTON SOUTH 352  
 COVID SEATING LAYOUT  
 3' SOCIAL DISTANCE

DRAWN BY: N. HUETTL

March 2021

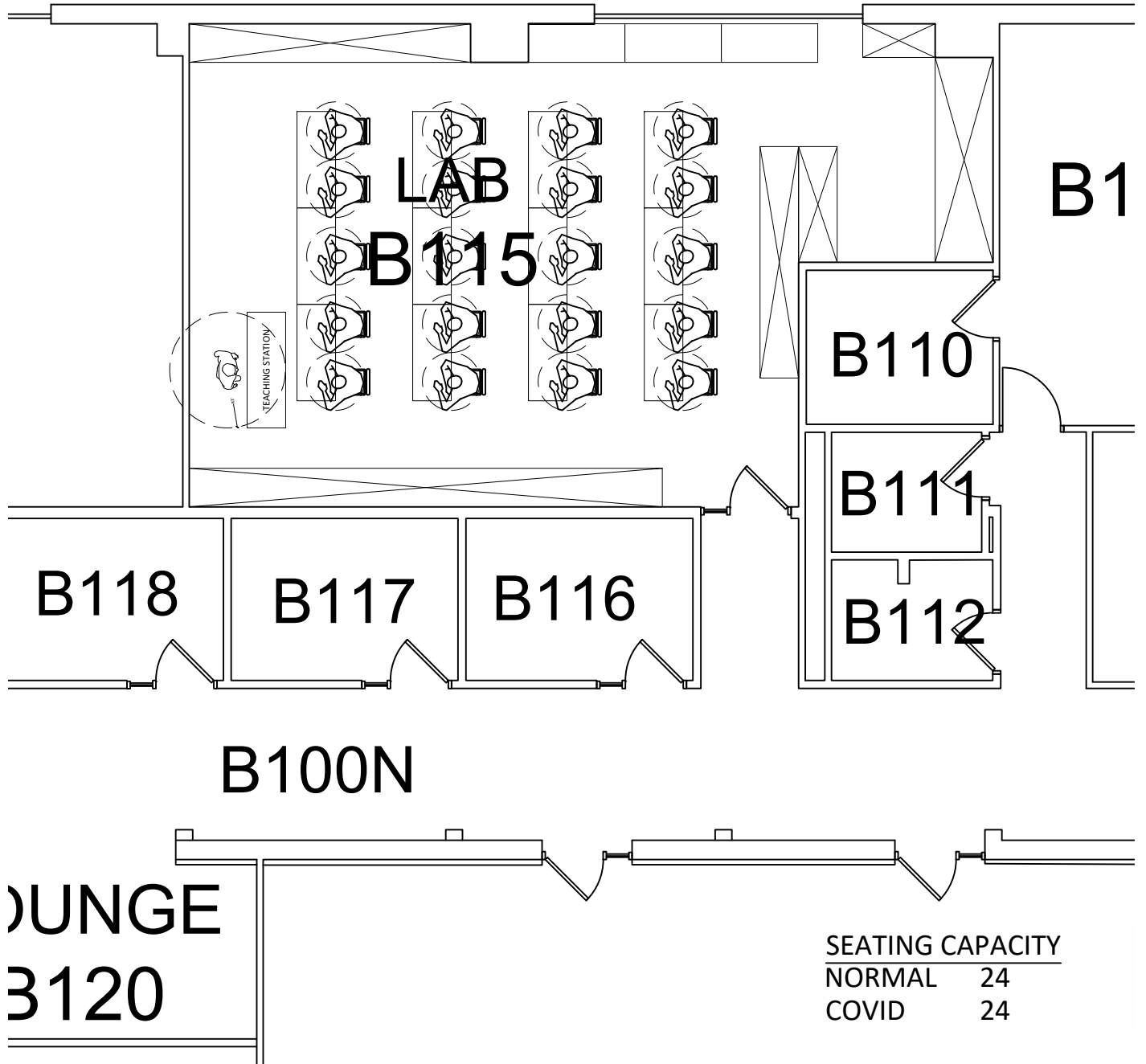
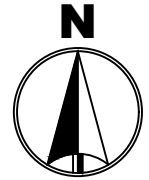

SEATING CAPACITY	
NORMAL	24
COVID	24



MINNESOTA STATE  
UNIVERSITY  
MANKATO  
PLANNING & CONSTRUCTION

WIECKING CENTER B115  
COVID SEATING LAYOUT  
3' SOCIAL DISTANCE

DRAWN BY: N. HUETTL

March 2021

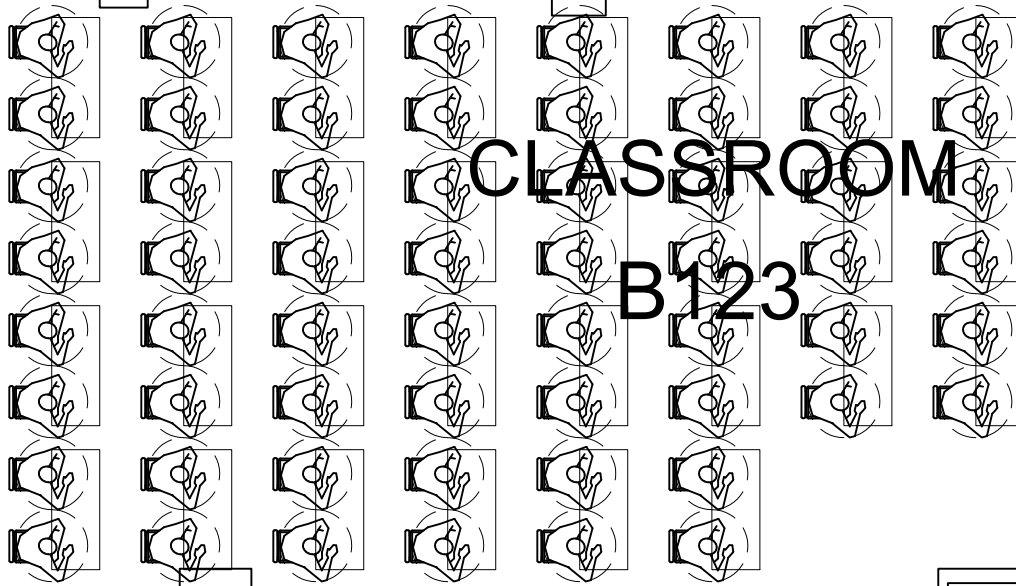

**B118**

**E**

**B134**

**LOUNGE**

SEATING CAPACITY

NORMAL 64

COVID 60

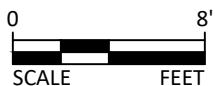

**MINNESOTA STATE UNIVERSITY**  
MANKATO

**PLANNING & CONSTRUCTION**

**WIECKING CENTER B123**

COVID SEATING LAYOUT

3' SOCIAL DISTANCE

DRAWN BY: N. HUETTL

March 2021



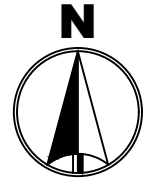

A110

DN

15A

CLASSROOM

B124

B132

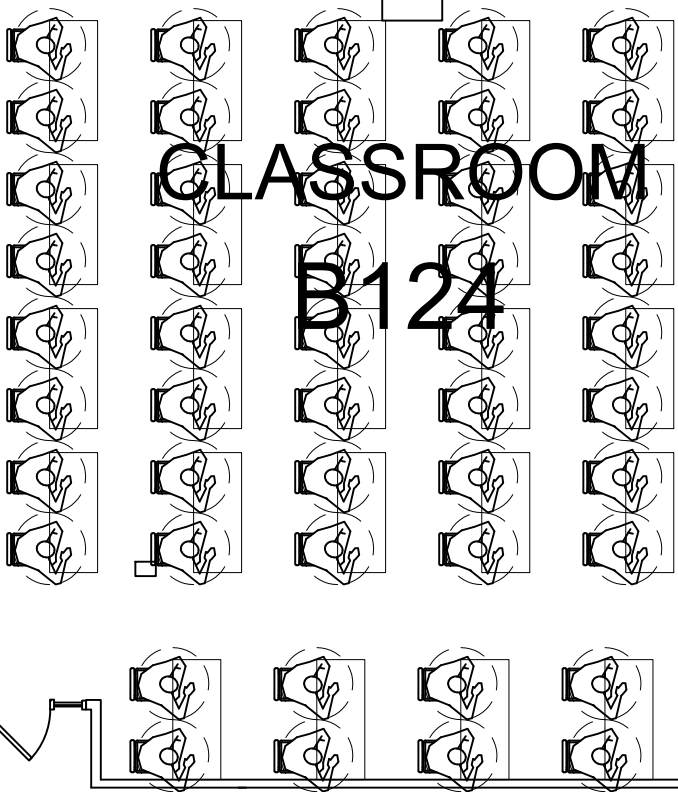

SEATING CAPACITY	
NORMAL	48
COVID	48



MINNESOTA STATE  
UNIVERSITY  
MANKATO  
PLANNING & CONSTRUCTION

WIECKING CENTER B124  
COVID SEATING LAYOUT  
3' SOCIAL DISTANCE

DRAWN BY: N. HUETTL

March 2021

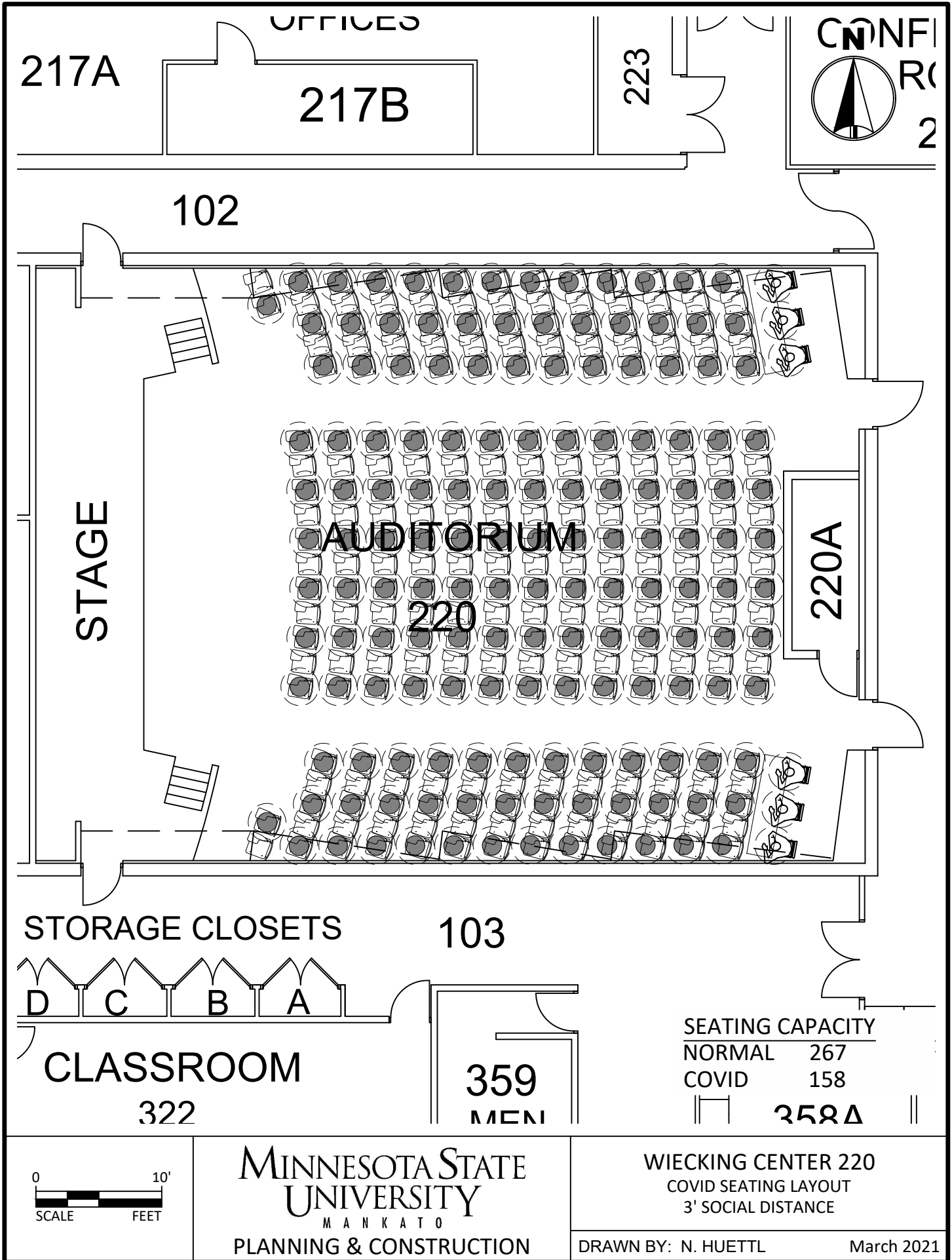

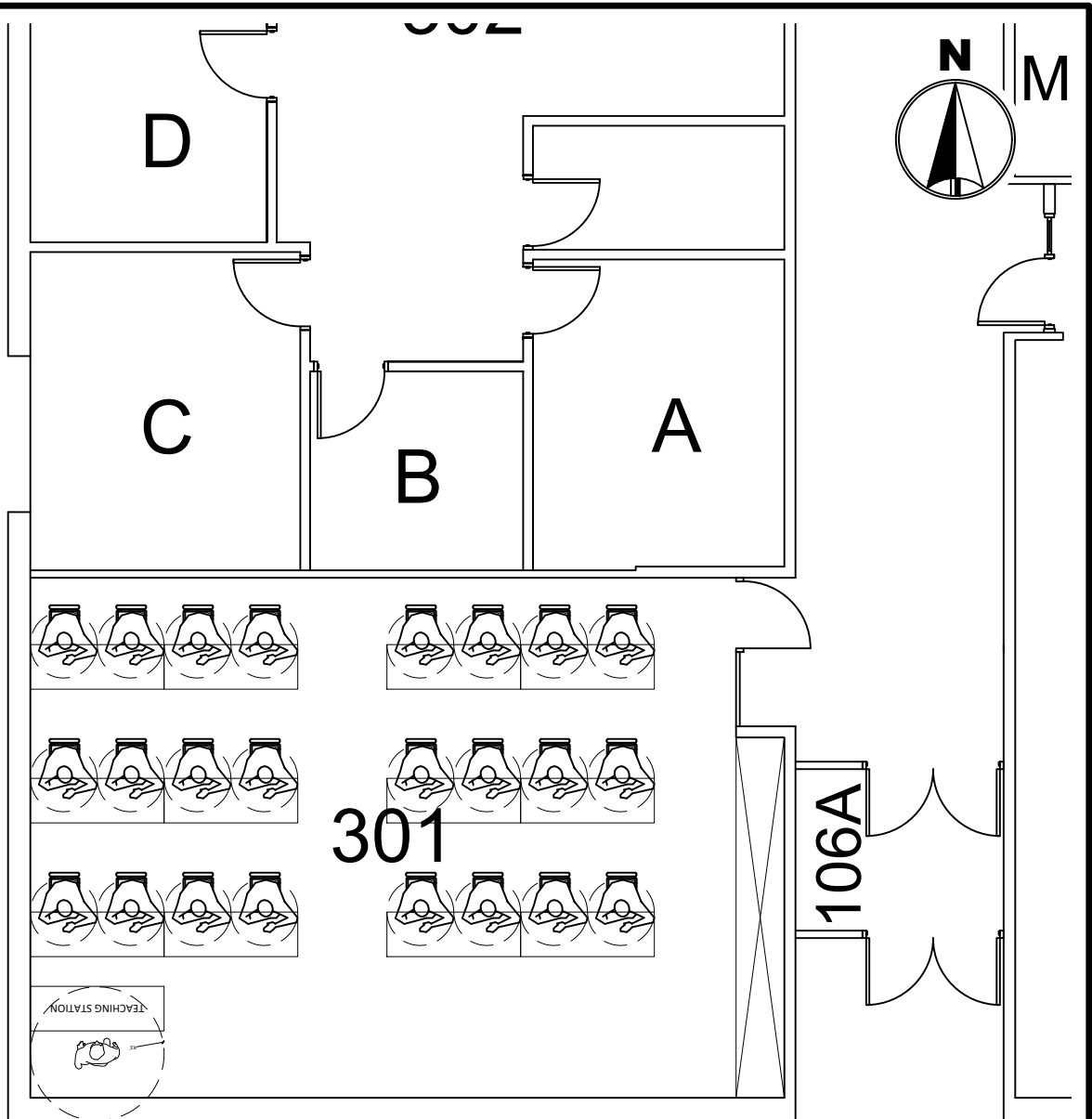

SEATING CAPACITY	
NORMAL	24
COVID	24

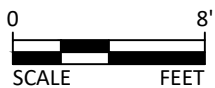

**MINNESOTA STATE UNIVERSITY**  
MANKATO  
**PLANNING & CONSTRUCTION**

**WIECKING CENTER 301**  
COVID SEATING LAYOUT  
3' SOCIAL DISTANCE

DRAWN BY: N. HUETTL

March 2021

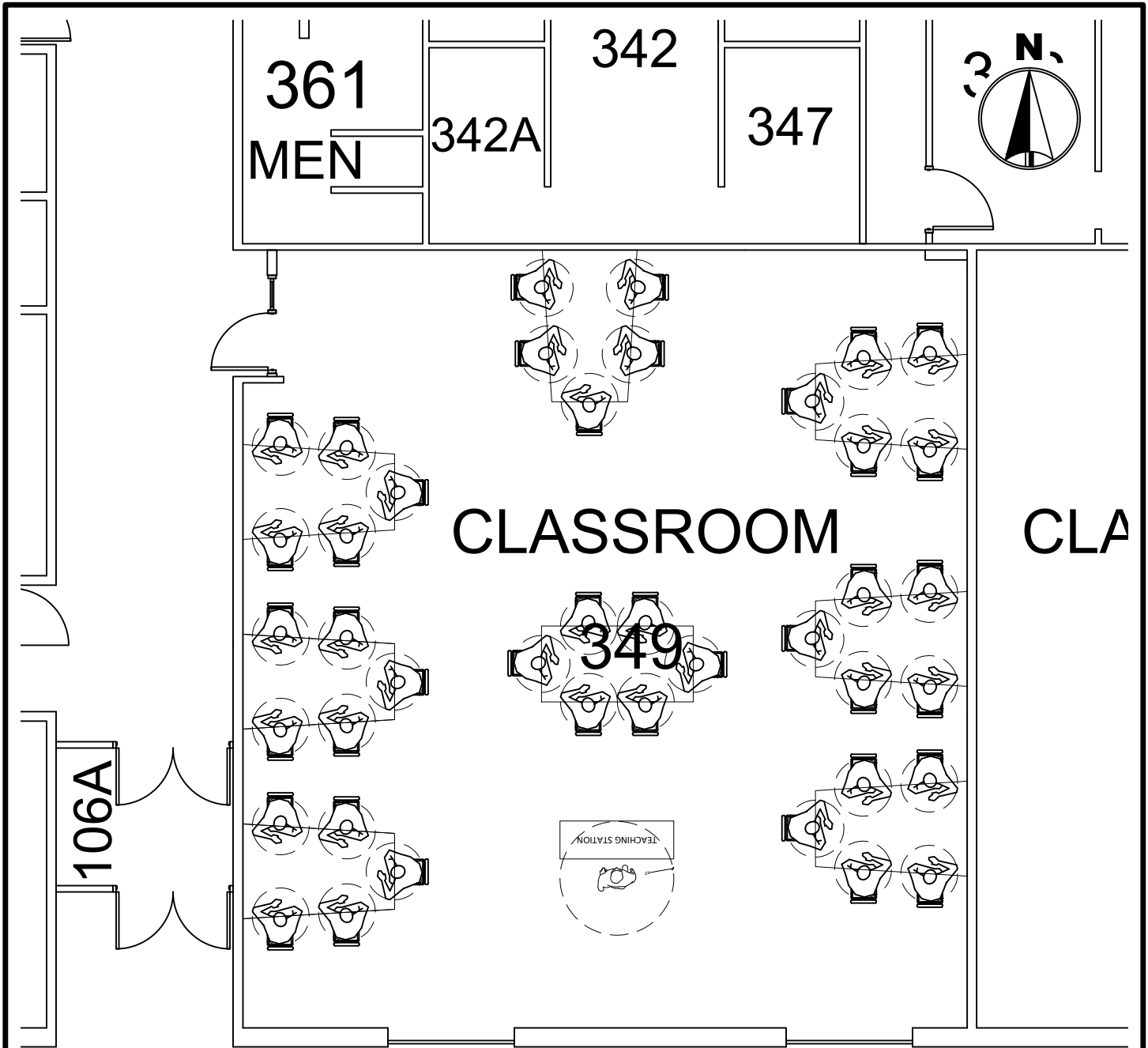

SEATING CAPACITY	
NORMAL	49
COVID	41



**MINNESOTA STATE UNIVERSITY**  
MANKATO  
PLANNING & CONSTRUCTION

**WIECKING CENTER 349**  
COVID SEATING LAYOUT  
3' SOCIAL DISTANCE

DRAWN BY: N. HUETTL

March 2021

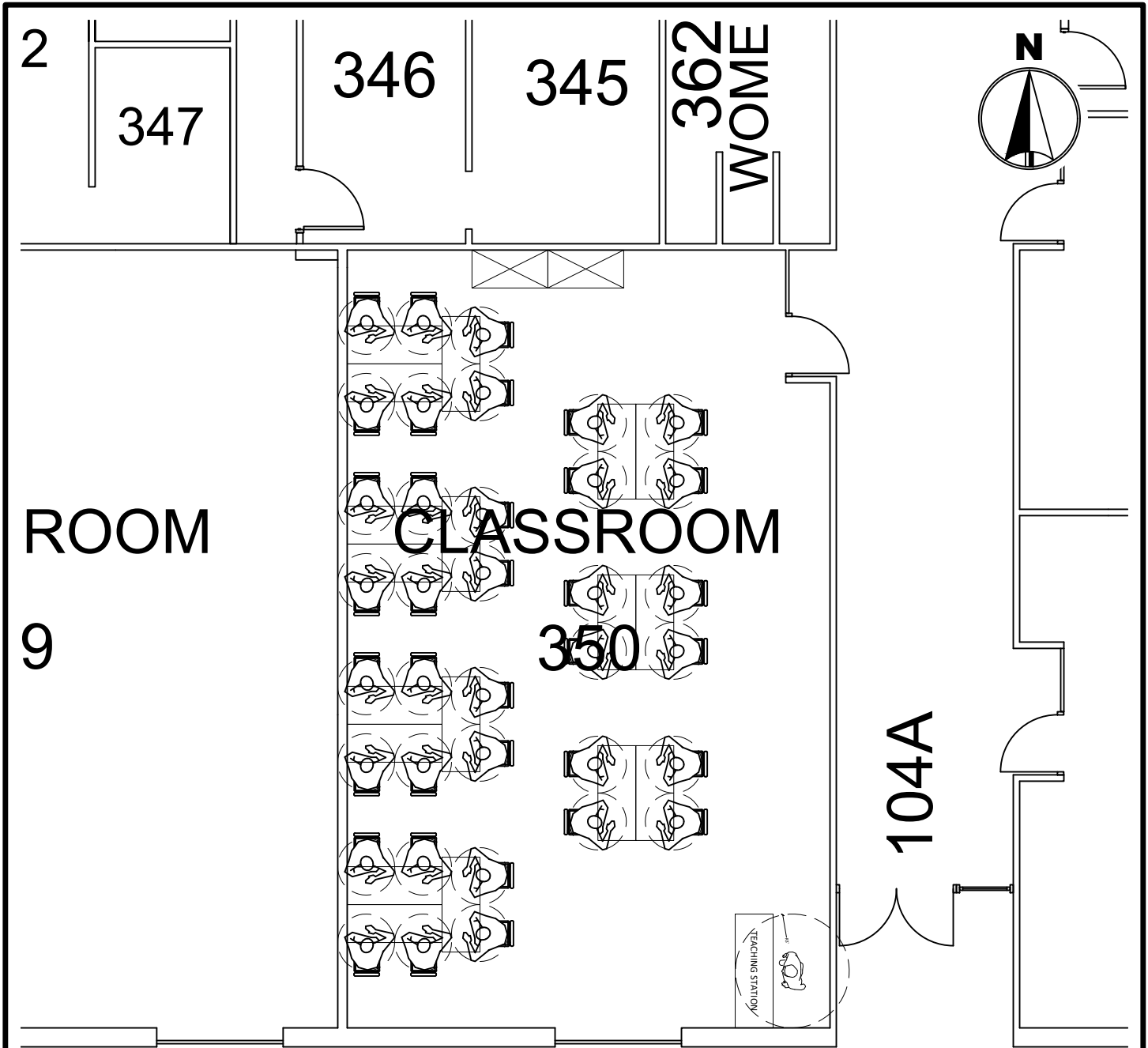

SEATING CAPACITY	
NORMAL	36
COVID	36



MINNESOTA STATE  
UNIVERSITY  
MANKATO  
PLANNING & CONSTRUCTION

WIECKING CENTER 350  
COVID SEATING LAYOUT  
3' SOCIAL DISTANCE

DRAWN BY: N. HUETTL

March 2021

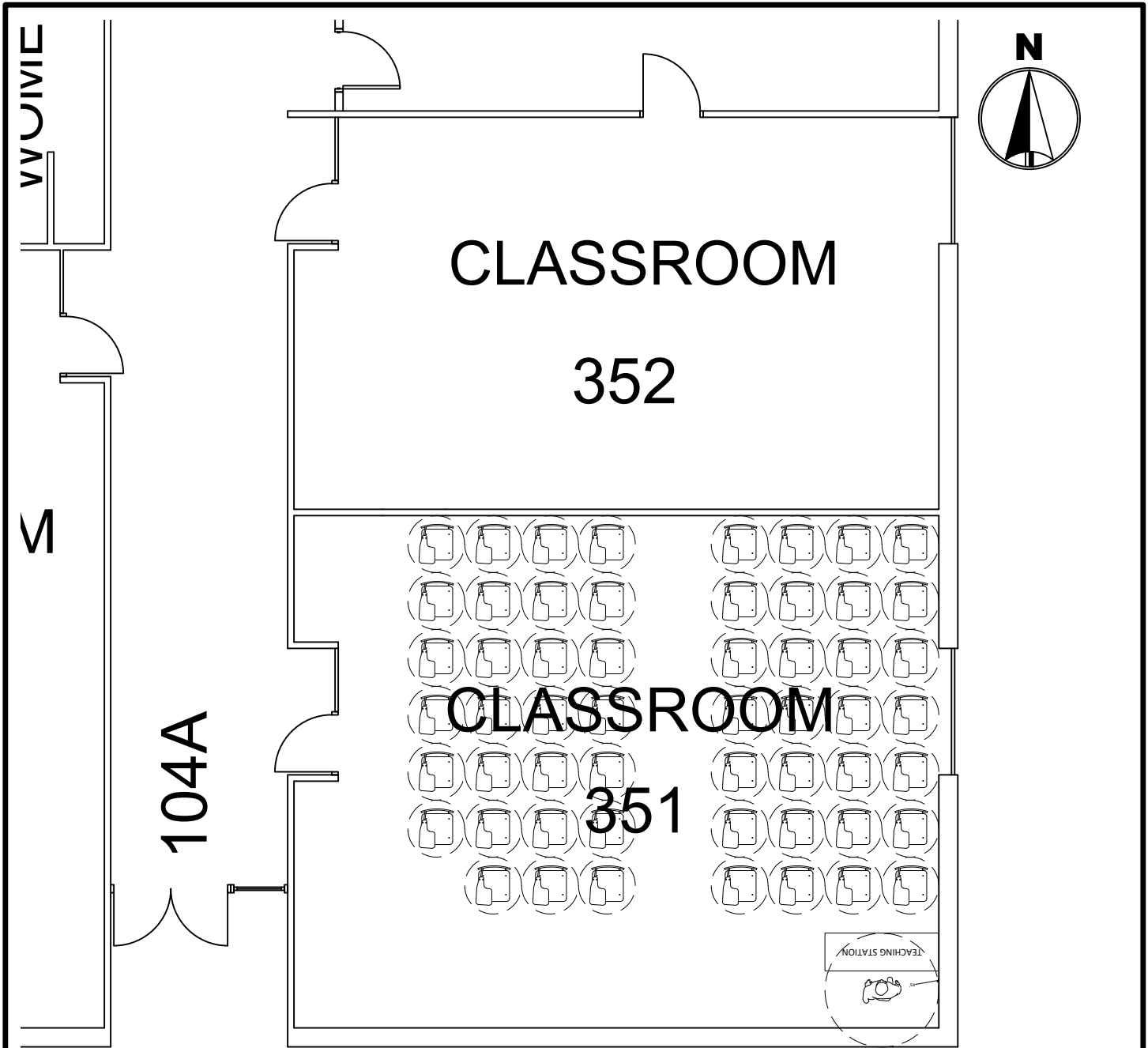

SEATING CAPACITY	
NORMAL	55
COVID	55



**MINNESOTA STATE UNIVERSITY**  
 MANKATO  
 PLANNING & CONSTRUCTION

**WIECKING CENTER 351**  
 COVID SEATING LAYOUT  
 3' SOCIAL DISTANCE

DRAWN BY: N. HUETTL

March 2021

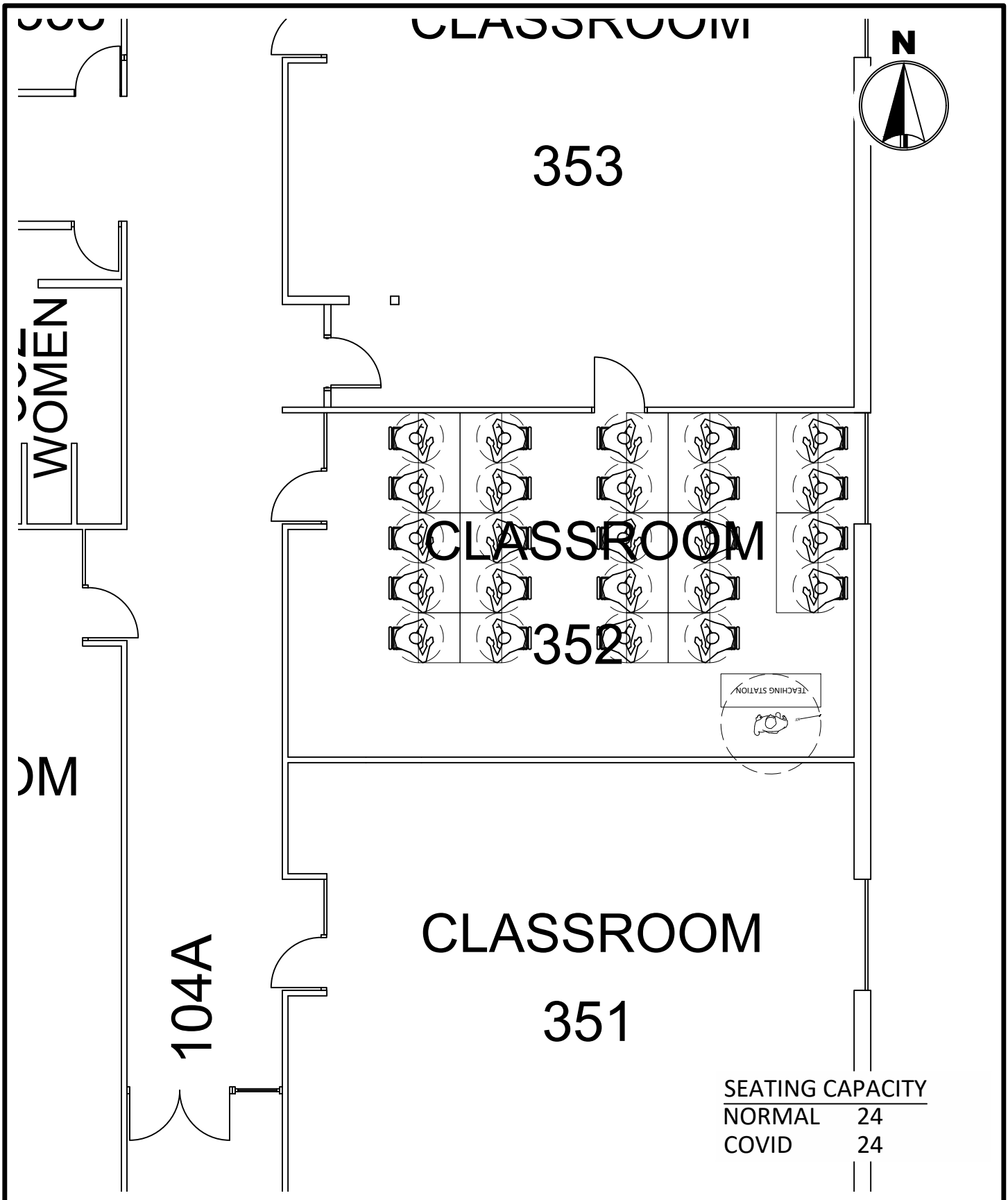

SEATING CAPACITY	
NORMAL	24
COVID	24



MINNESOTA STATE  
UNIVERSITY  
MANKATO  
PLANNING & CONSTRUCTION

WIECKING CENTER 352  
COVID SEATING LAYOUT  
3' SOCIAL DISTANCE

DRAWN BY: N. HUETTL

March 2021

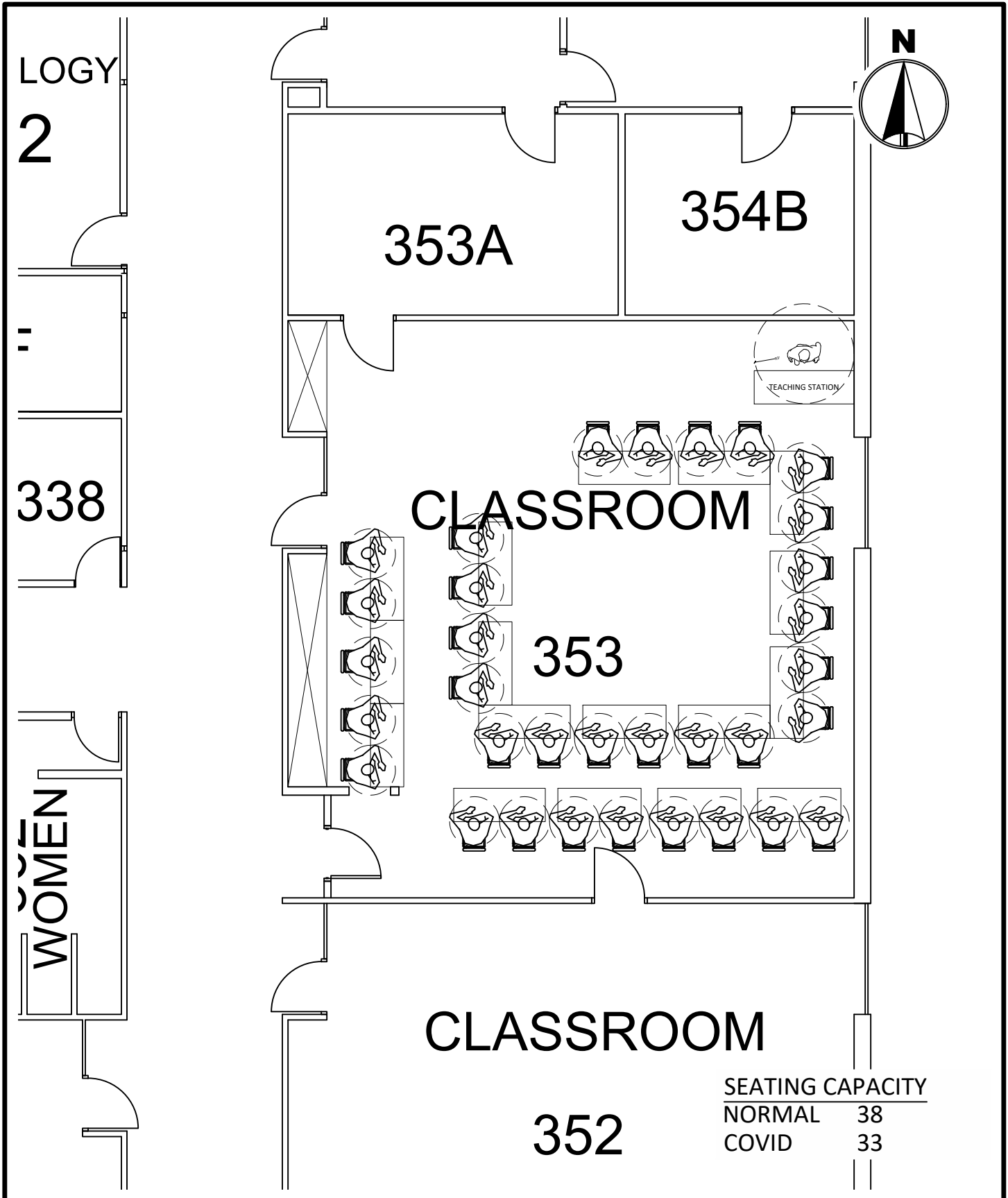

MINNESOTA STATE  
UNIVERSITY  
MANKATO  
PLANNING & CONSTRUCTION

WIECKING CENTER 353  
COVID SEATING LAYOUT  
3' SOCIAL DISTANCE

DRAWN BY: N. HUETTL

March 2021



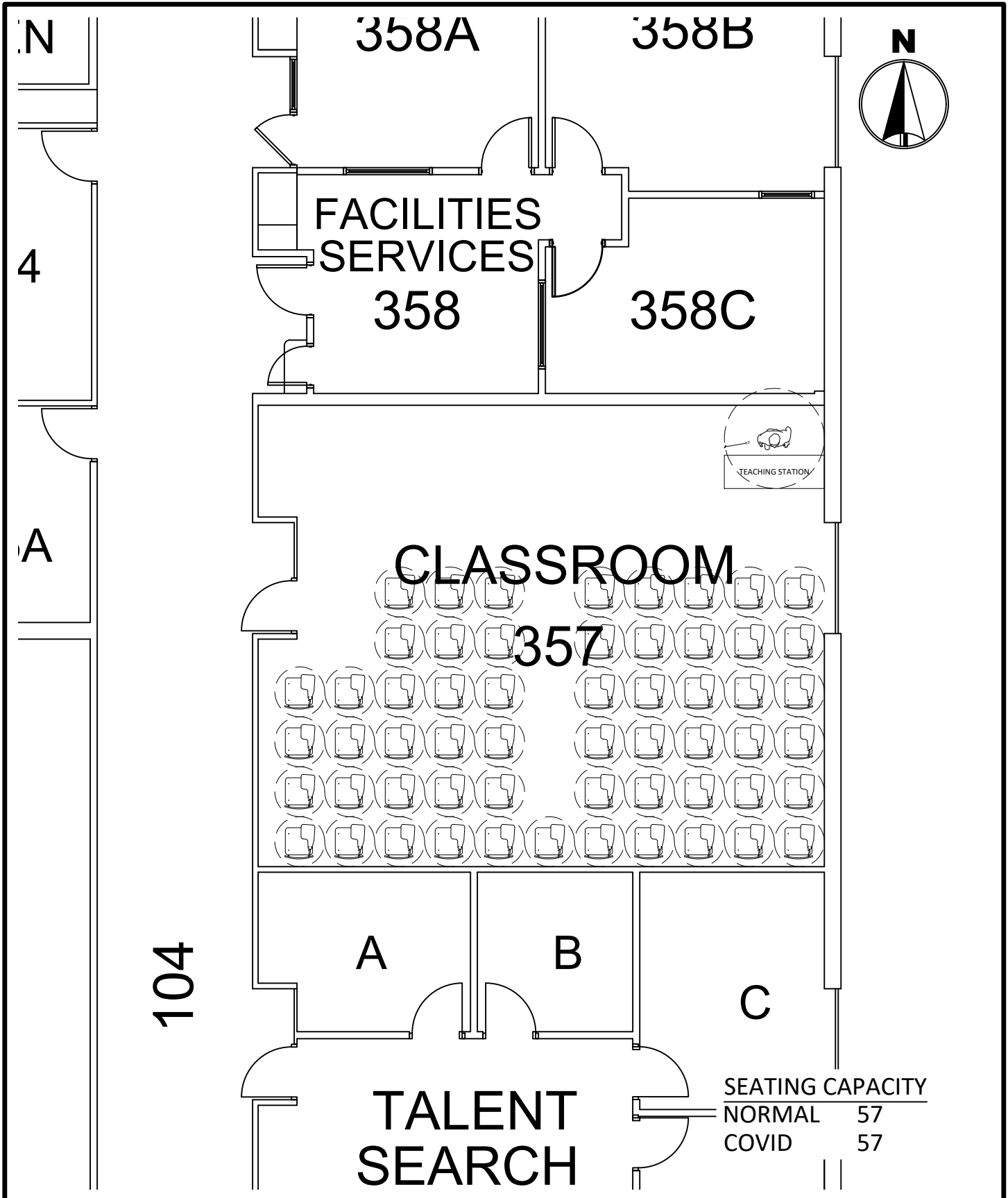

**MINNESOTA STATE UNIVERSITY**  
MANKATO  
**PLANNING & CONSTRUCTION**

**WIECKING CENTER 357**  
COVID SEATING LAYOUT  
3' SOCIAL DISTANCE

DRAWN BY: N. HUETTL

March 2021

116

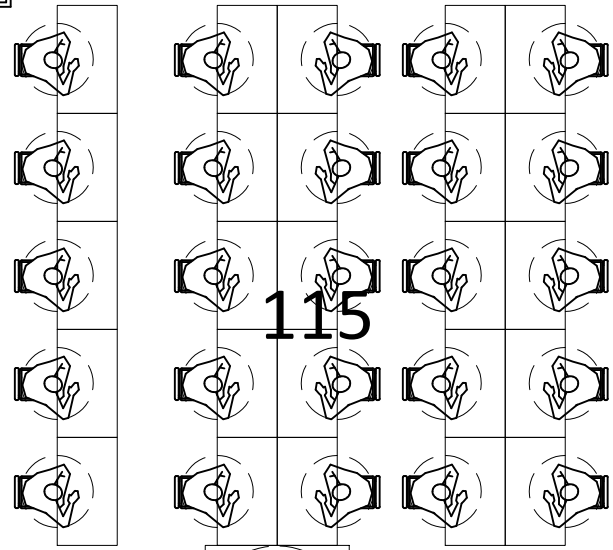
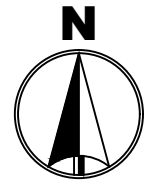

115



102

WH 1

114

UP

DN

113

SEATING CAPACITY	
NORMAL	25
COVID	25



MINNESOTA STATE  
UNIVERSITY  
MANKATO  
PLANNING & CONSTRUCTION

WISSINK HALL 115  
COVID SEATING LAYOUT  
3' SOCIAL DISTANCE

DRAWN BY: N. HUETTL

March 2021

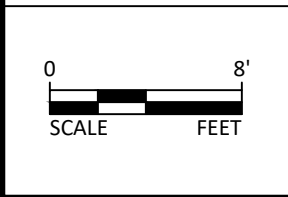
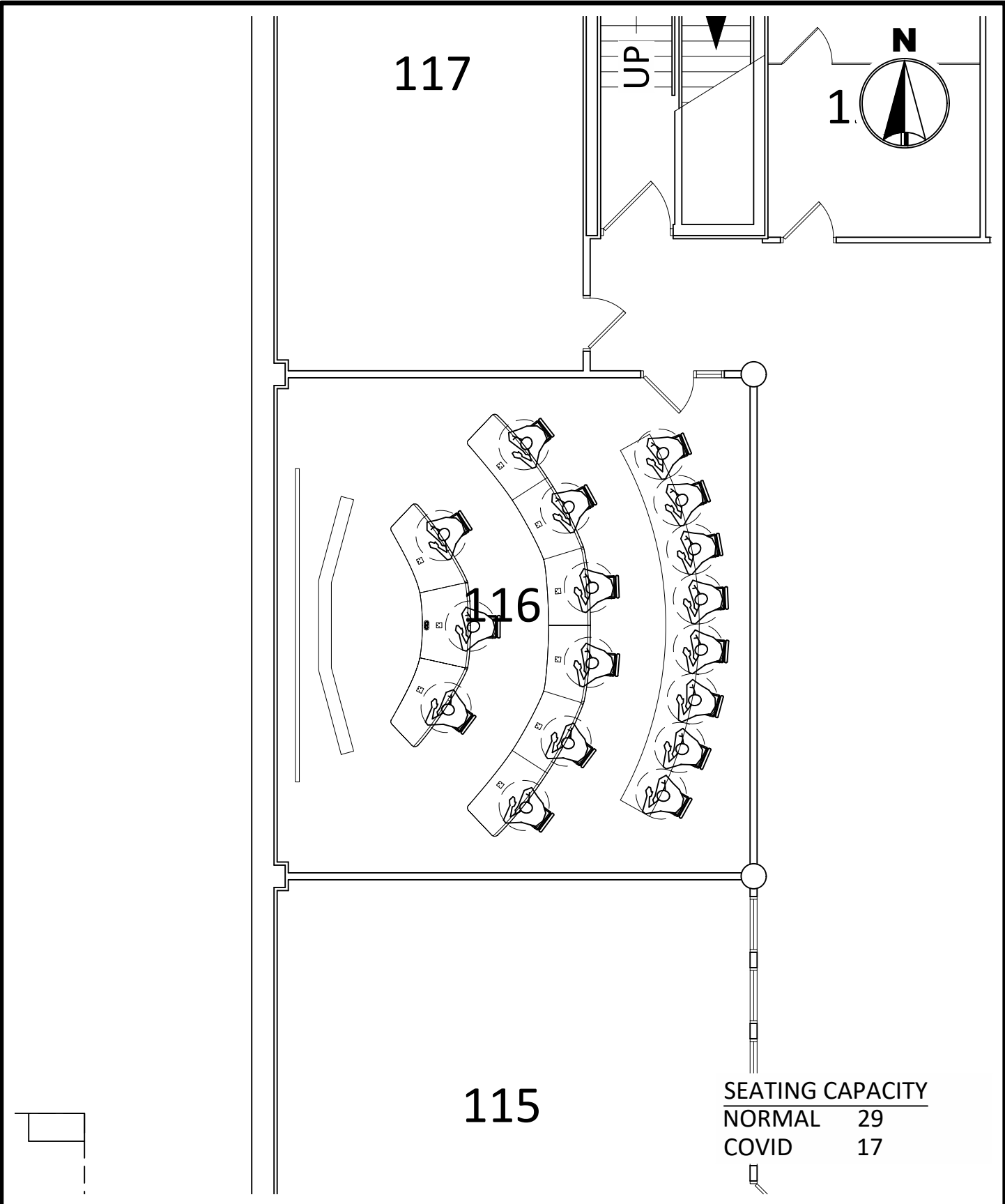

MINNESOTA STATE UNIVERSITY  
MANKATO  
PLANNING & CONSTRUCTION

WISSINK HALL 116  
COVID SEATING LAYOUT  
3' SOCIAL DISTANCE

DRAWN BY: N. HUETTL March 2021

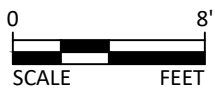
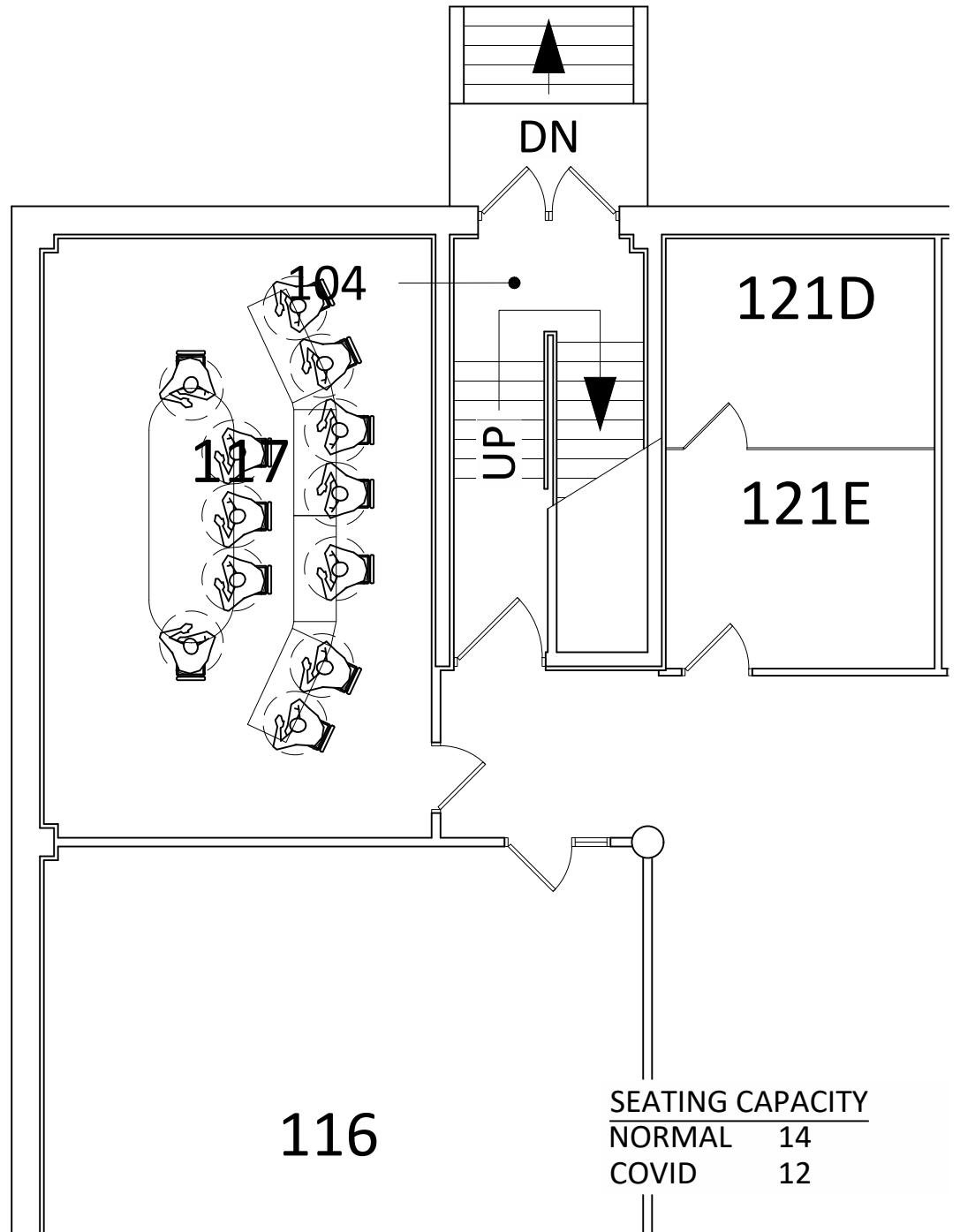

MINNESOTA STATE  
UNIVERSITY  
MANKATO  
PLANNING & CONSTRUCTION

WISSINK HALL 117  
COVID SEATING LAYOUT  
3' SOCIAL DISTANCE

DRAWN BY: N. HUETTL

March 2021

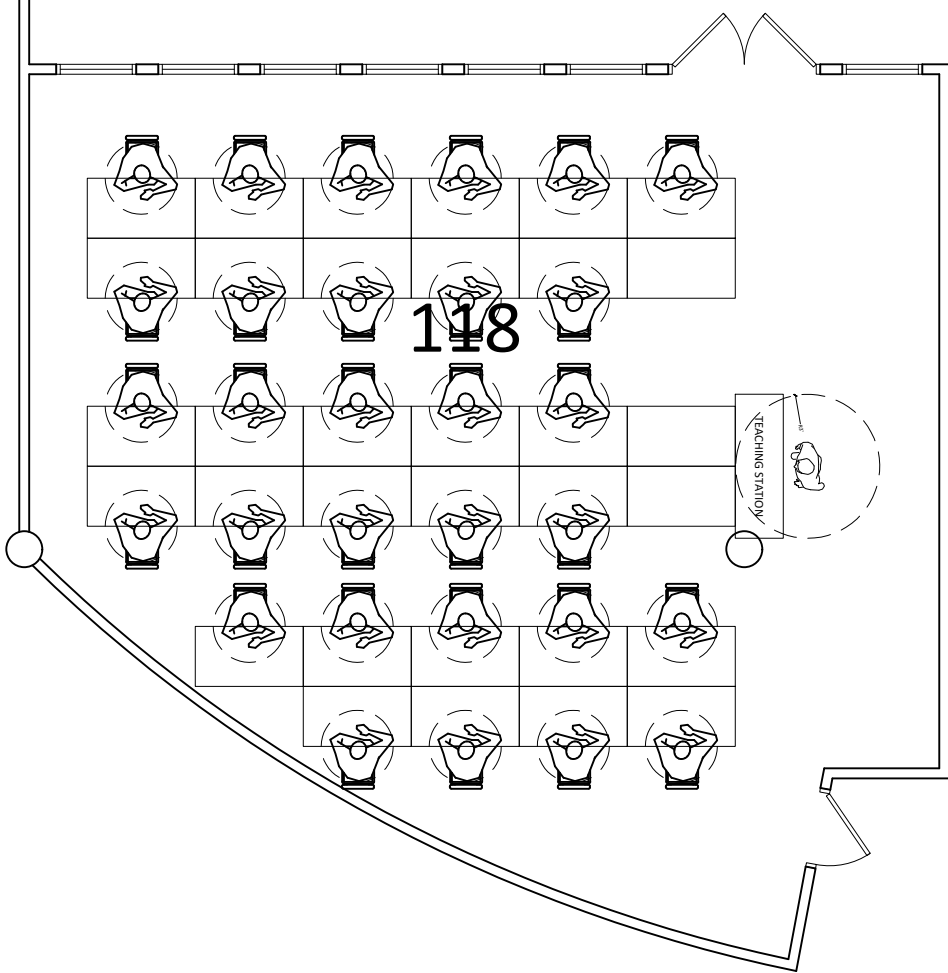
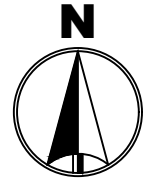

148

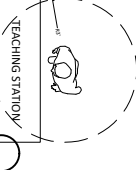

10

SEATING CAPACITY	
NORMAL	30
COVID	30



**MINNESOTA STATE UNIVERSITY**  
MANKATO  
**PLANNING & CONSTRUCTION**

**WISSINK HALL 118**  
COVID SEATING LAYOUT  
3' SOCIAL DISTANCE

DRAWN BY: N. HUETTL

March 2021

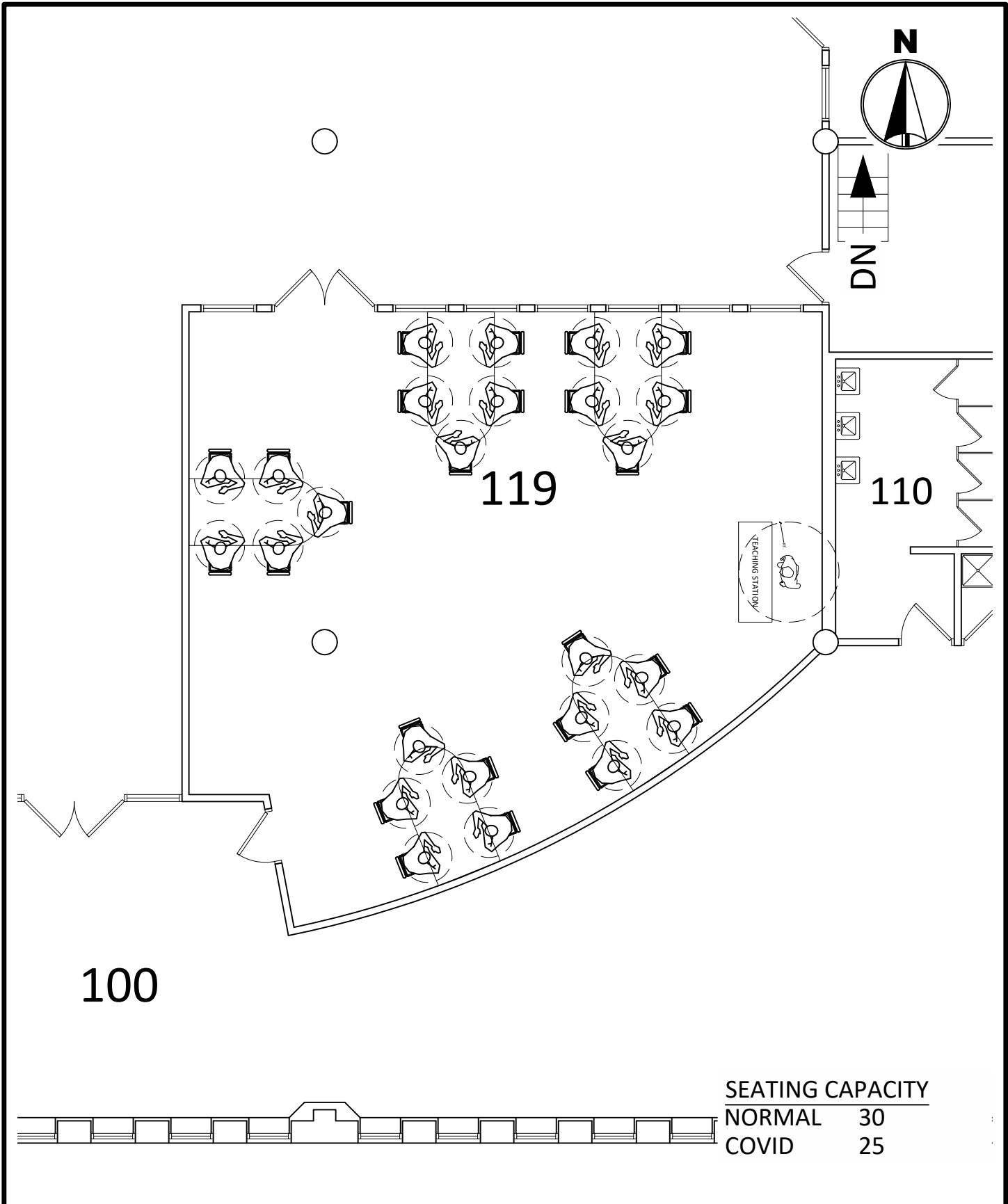

MINNESOTA STATE  
UNIVERSITY  
MANKATO  
PLANNING & CONSTRUCTION

WISSINK HALL 119  
COVID SEATING LAYOUT  
3' SOCIAL DISTANCE

DRAWN BY: N. HUETTL

March 2021

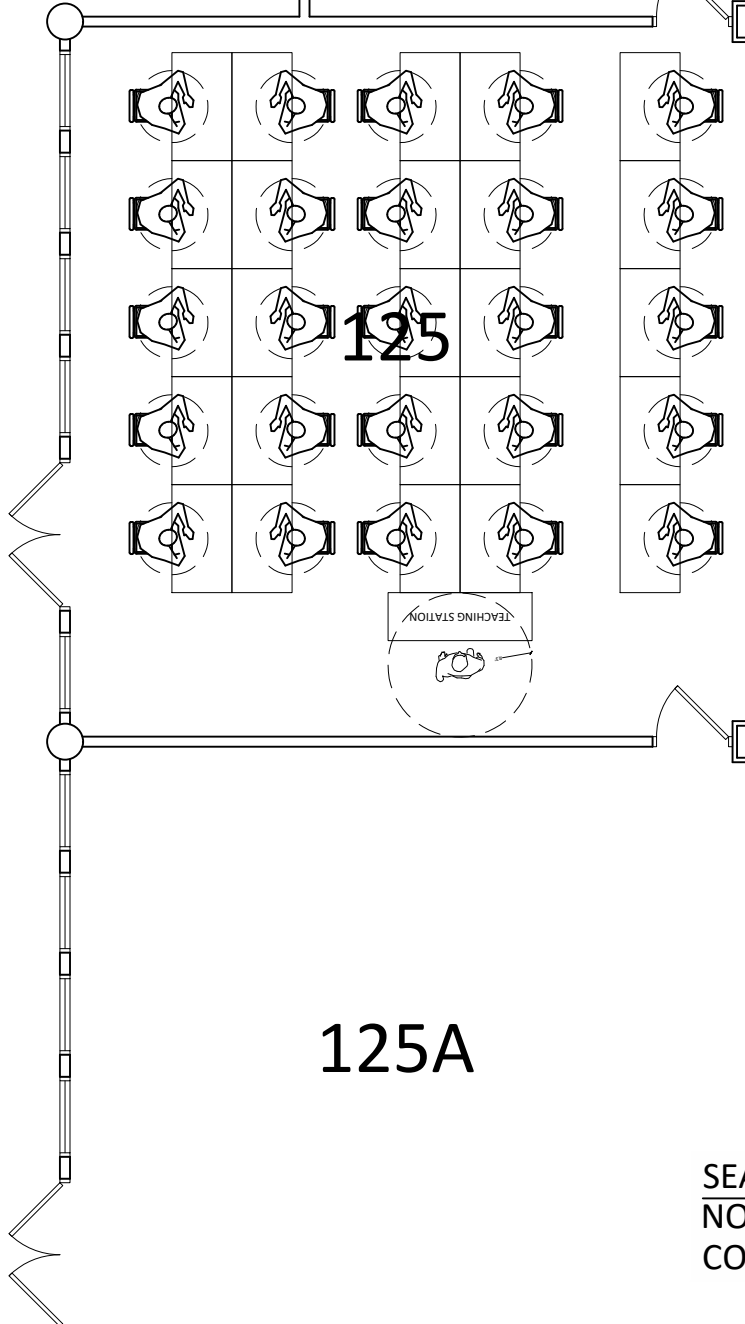
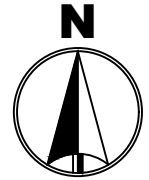

SEATING CAPACITY	
NORMAL	25
COVID	25



MINNESOTA STATE  
UNIVERSITY  
MANKATO  
PLANNING & CONSTRUCTION

WISSINK HALL 125  
COVID SEATING LAYOUT  
3' SOCIAL DISTANCE

DRAWN BY: N. HUETTL

March 2021

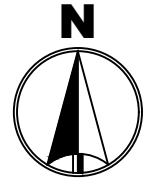

121C

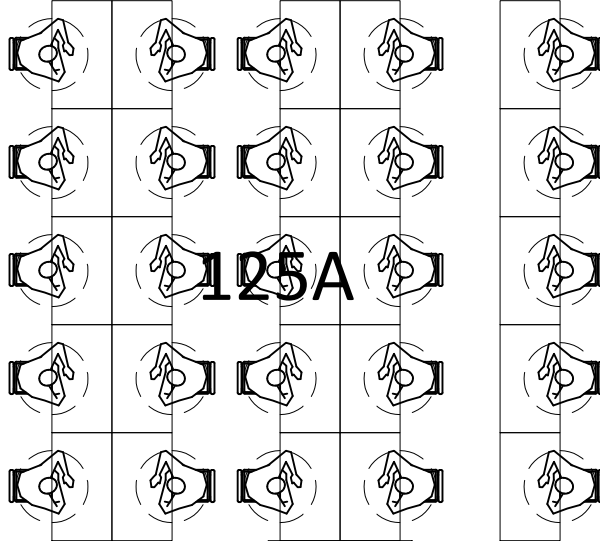
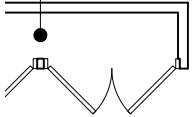

125A

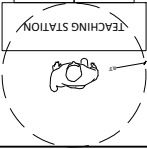

125

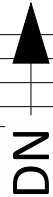

STAIR G

110

111

112

SEATING CAPACITY	
NORMAL	25
COVID	25



MINNESOTA STATE UNIVERSITY  
MANKATO

PLANNING & CONSTRUCTION

WISSINK HALL 125A  
COVID SEATING LAYOUT  
3' SOCIAL DISTANCE

DRAWN BY: N. HUETTL

March 2021



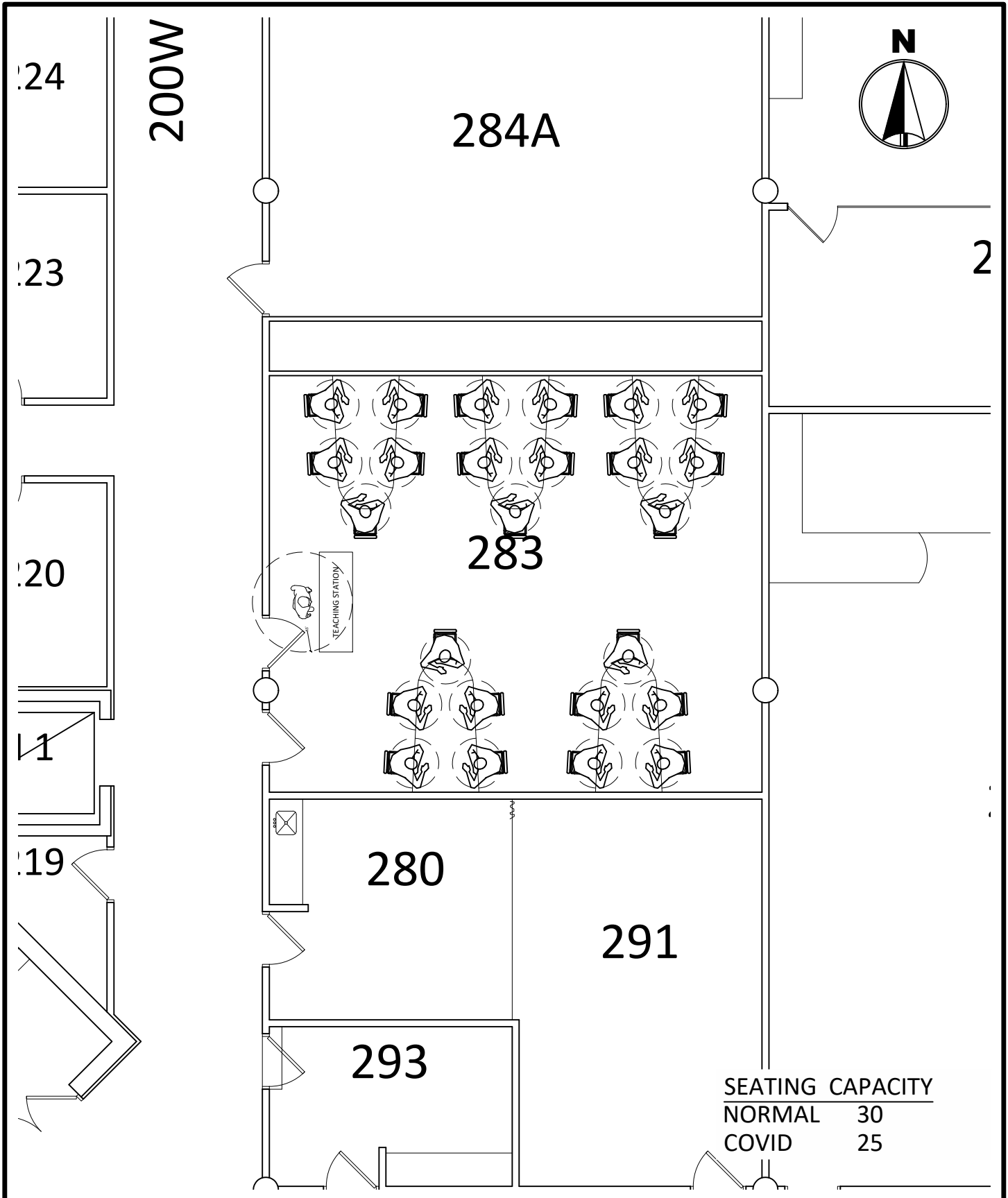

SEATING CAPACITY	
NORMAL	30
COVID	25



MINNESOTA STATE  
UNIVERSITY  
MANKATO  
PLANNING & CONSTRUCTION

WISSINK HALL 283  
COVID SEATING LAYOUT  
3' SOCIAL DISTANCE

DRAWN BY: N. HUETTL

March 2021

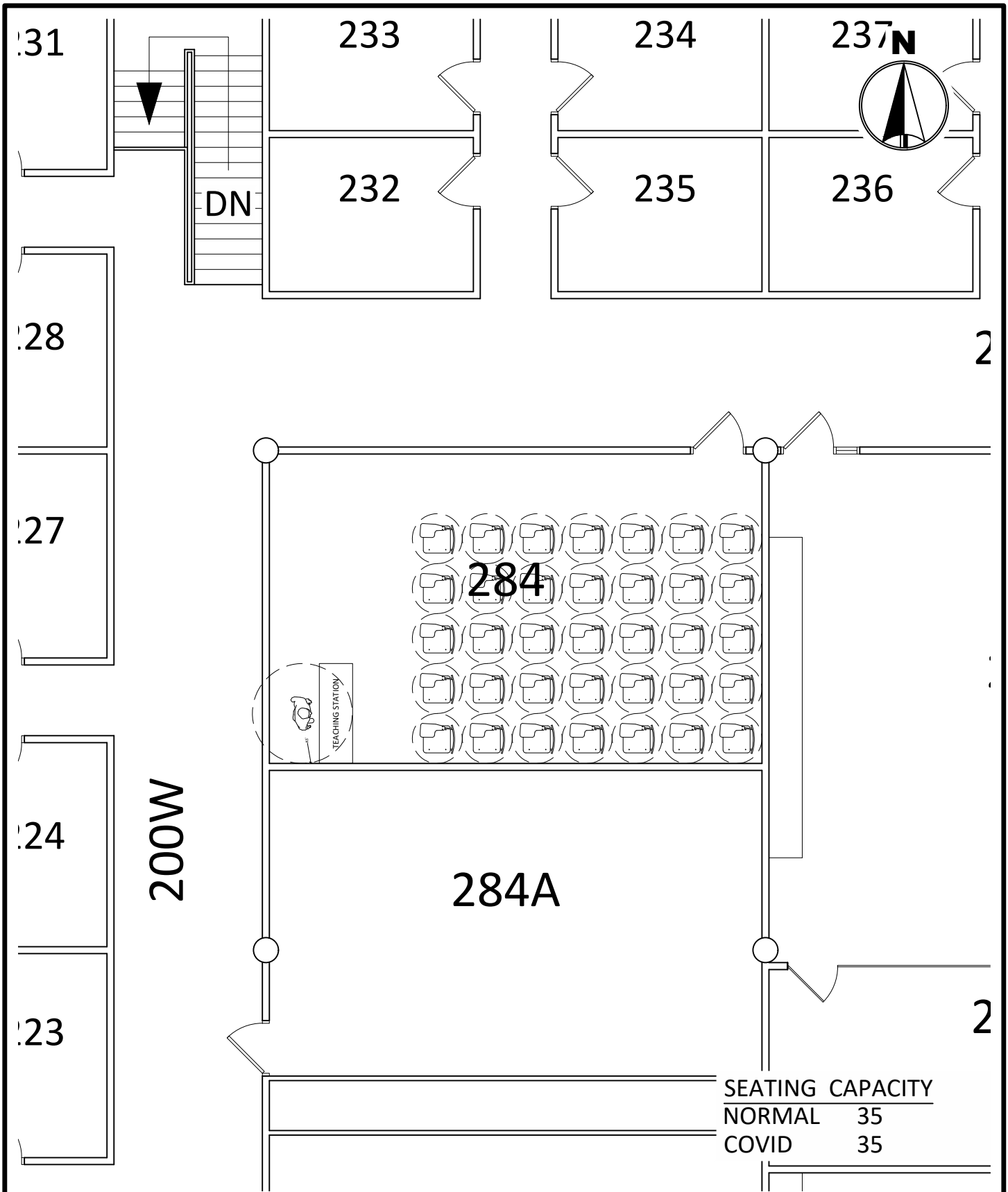

MINNESOTA STATE  
UNIVERSITY  
MANKATO  
PLANNING & CONSTRUCTION

WISSINK HALL 284  
COVID SEATING LAYOUT  
3' SOCIAL DISTANCE

DRAWN BY: N. HUETTL

March 2021

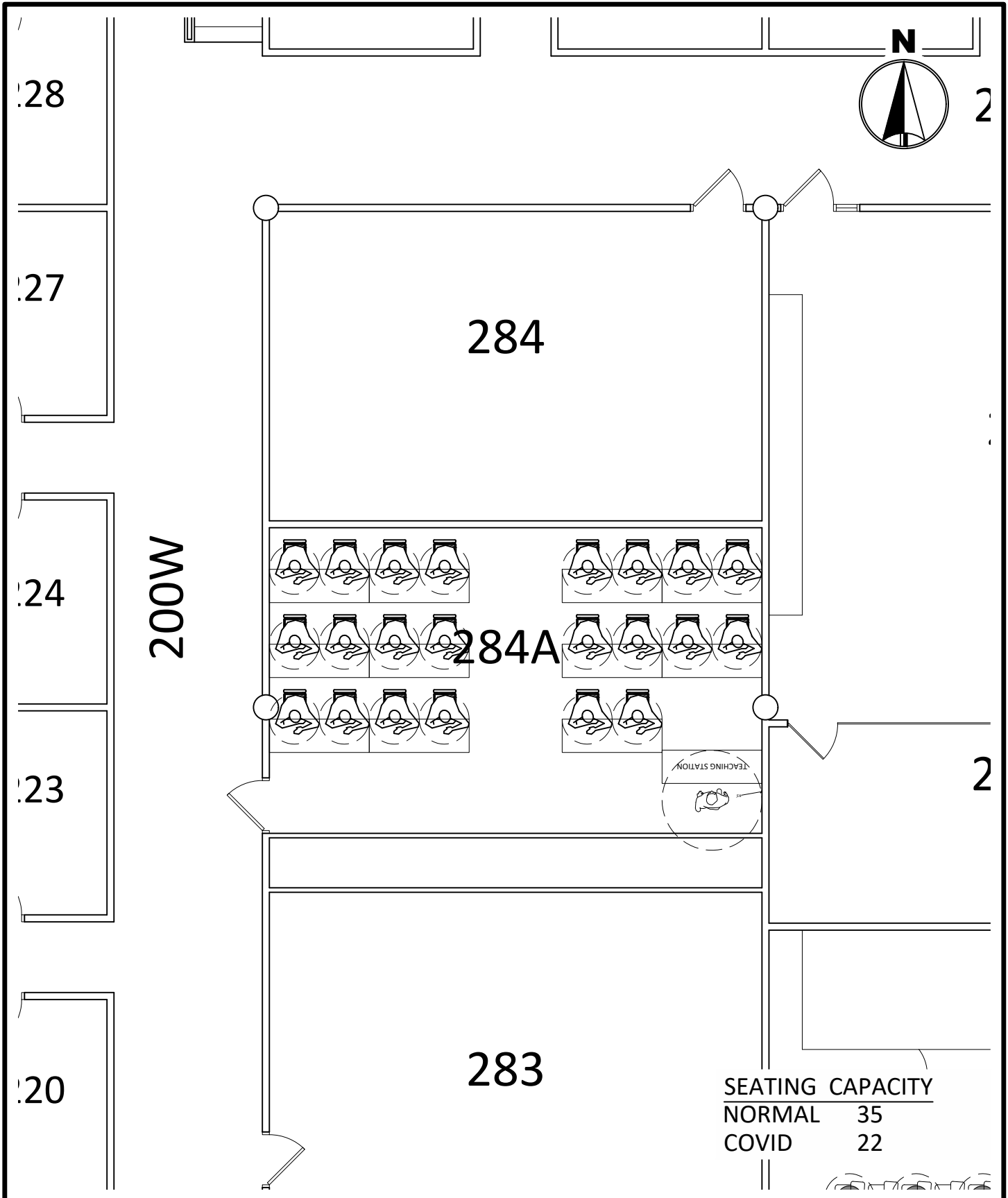

MINNESOTA STATE UNIVERSITY  
MANKATO  
PLANNING & CONSTRUCTION

WISSINK HALL 284A  
COVID SEATING LAYOUT  
3' SOCIAL DISTANCE

DRAWN BY: N. HUETTL March 2021

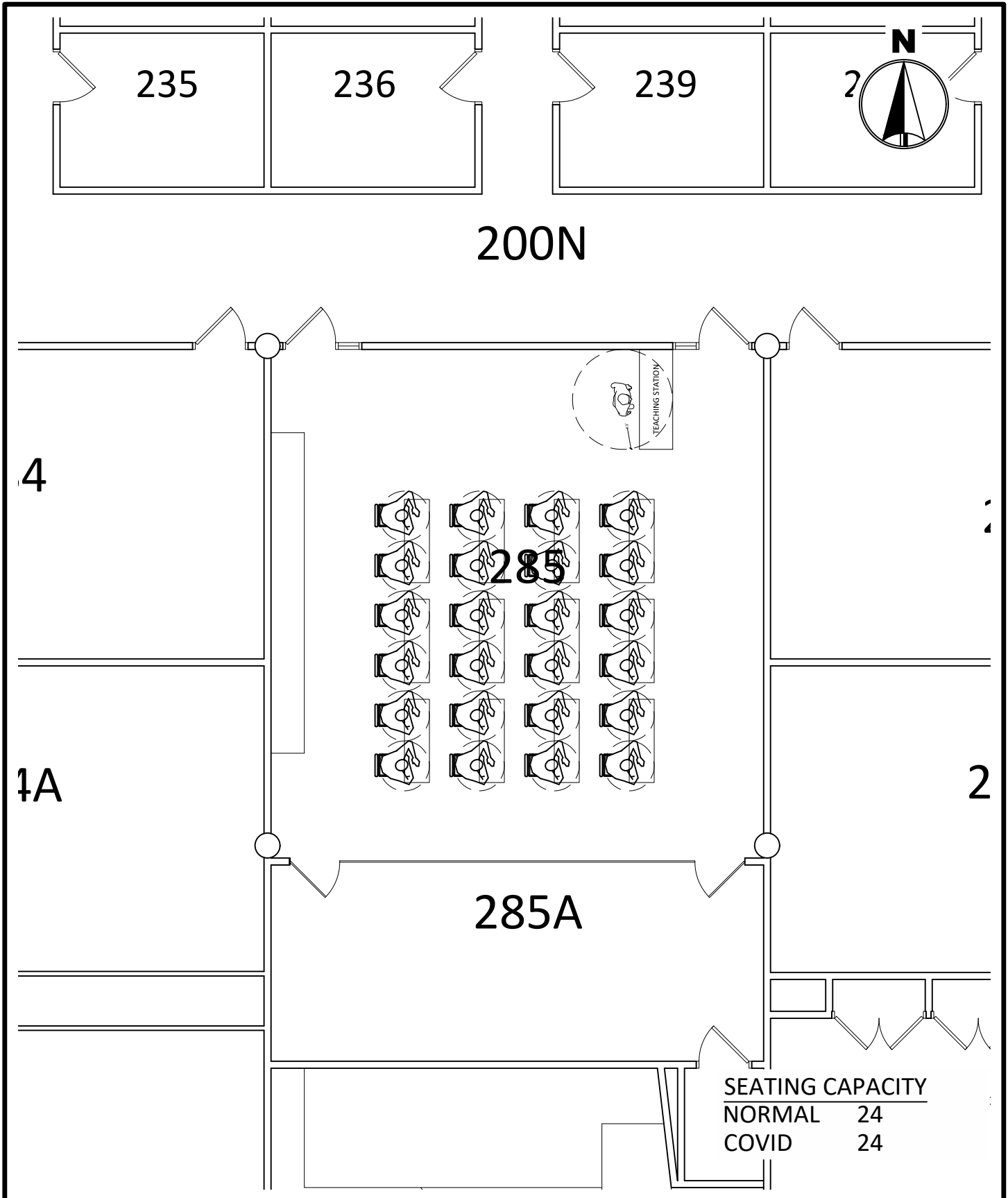

**MINNESOTA STATE UNIVERSITY**  
 MANKATO  
 PLANNING & CONSTRUCTION

**WISSINK HALL 285**  
 COVID SEATING LAYOUT  
 3' SOCIAL DISTANCE

DRAWN BY: N. HUETTL

March 2021

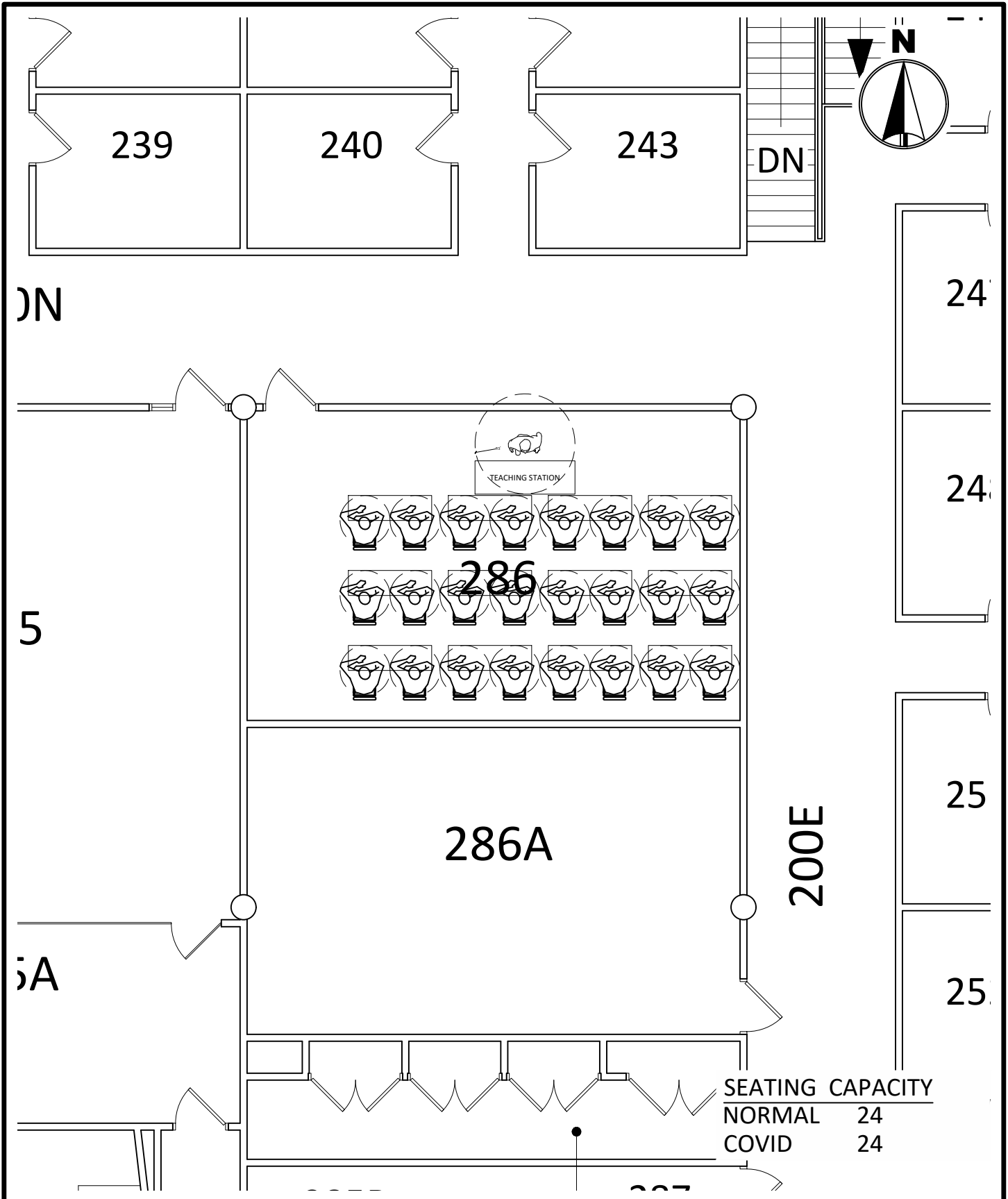

MINNESOTA STATE  
UNIVERSITY  
MANKATO  
PLANNING & CONSTRUCTION

WISSINK HALL 286  
COVID SEATING LAYOUT  
3' SOCIAL DISTANCE

DRAWN BY: N. HUETTL

March 2021

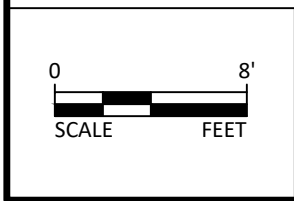
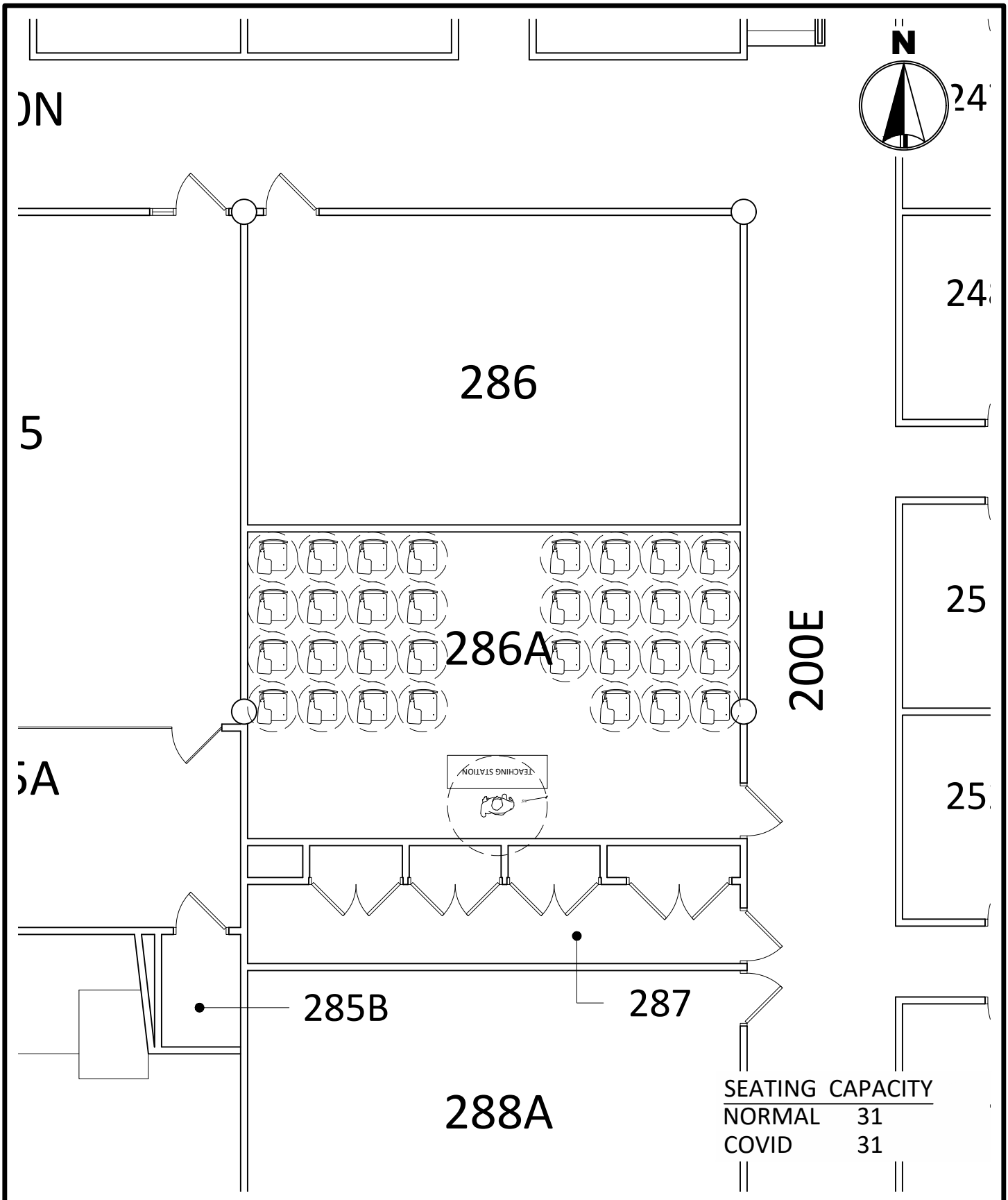

MINNESOTA STATE UNIVERSITY  
MANKATO  
PLANNING & CONSTRUCTION

WISSINK HALL 286A  
COVID SEATING LAYOUT  
3' SOCIAL DISTANCE

DRAWN BY: N. HUETTL March 2021

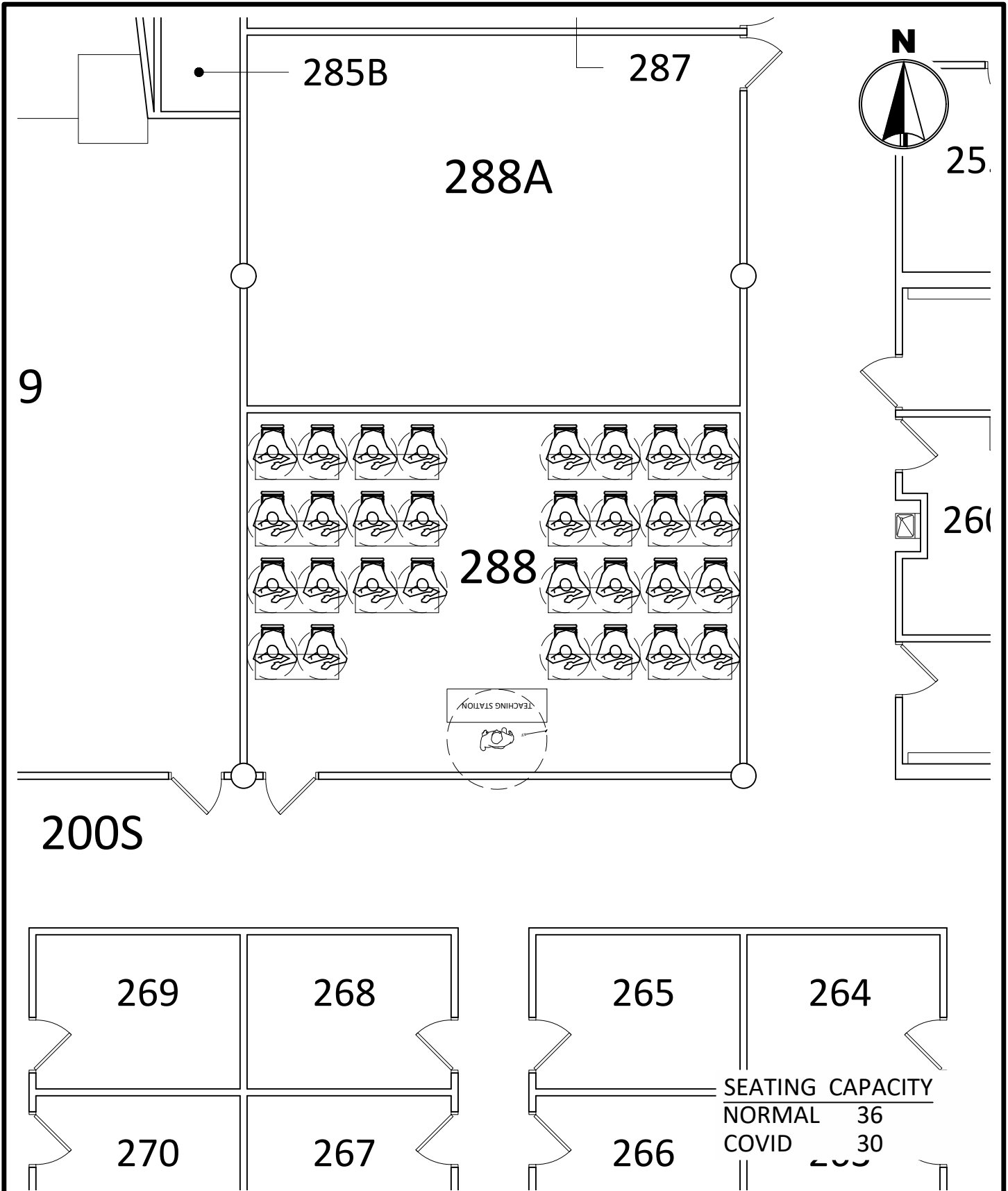

MINNESOTA STATE UNIVERSITY  
MANKATO

PLANNING & CONSTRUCTION

WISSINK HALL 288  
COVID SEATING LAYOUT  
3' SOCIAL DISTANCE

DRAWN BY: N. HUETTL

March 2021

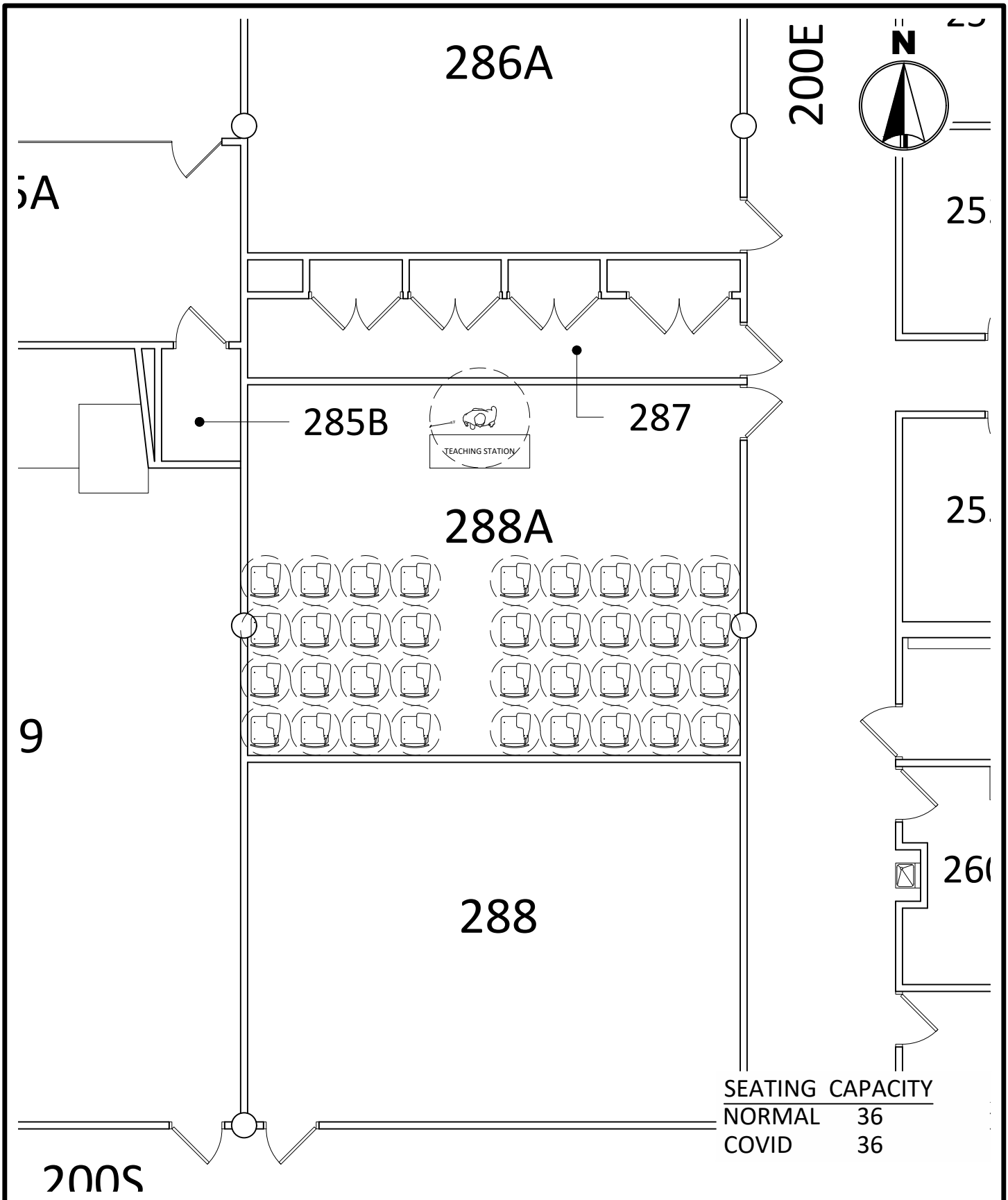

MINNESOTA STATE  
UNIVERSITY  
MANKATO  
PLANNING & CONSTRUCTION

WISSINK HALL 288A  
COVID SEATING LAYOUT  
3' SOCIAL DISTANCE

DRAWN BY: N. HUETTL

March 2021



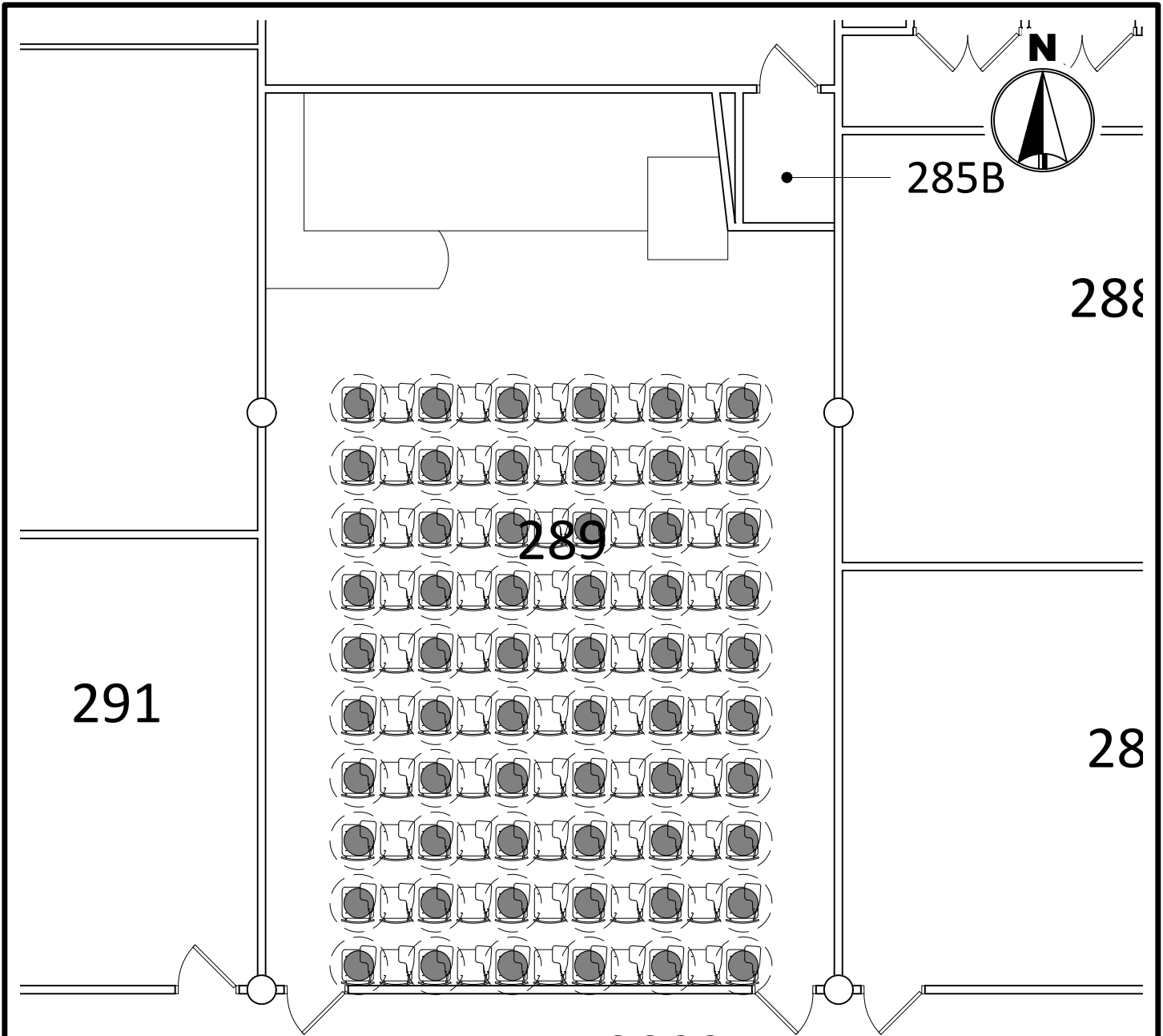

200S

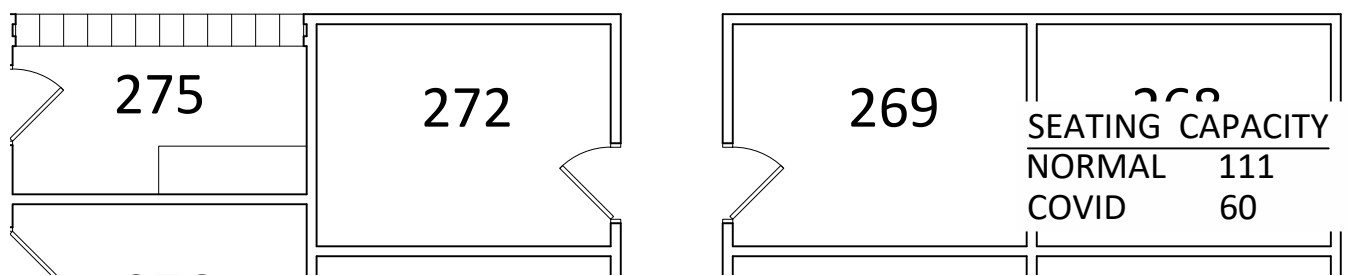

**MINNESOTA STATE UNIVERSITY**  
MANKATO  
PLANNING & CONSTRUCTION

WISSINK HALL 289  
COVID SEATING LAYOUT  
3' SOCIAL DISTANCE

DRAWN BY: N. HUETTL March 2021

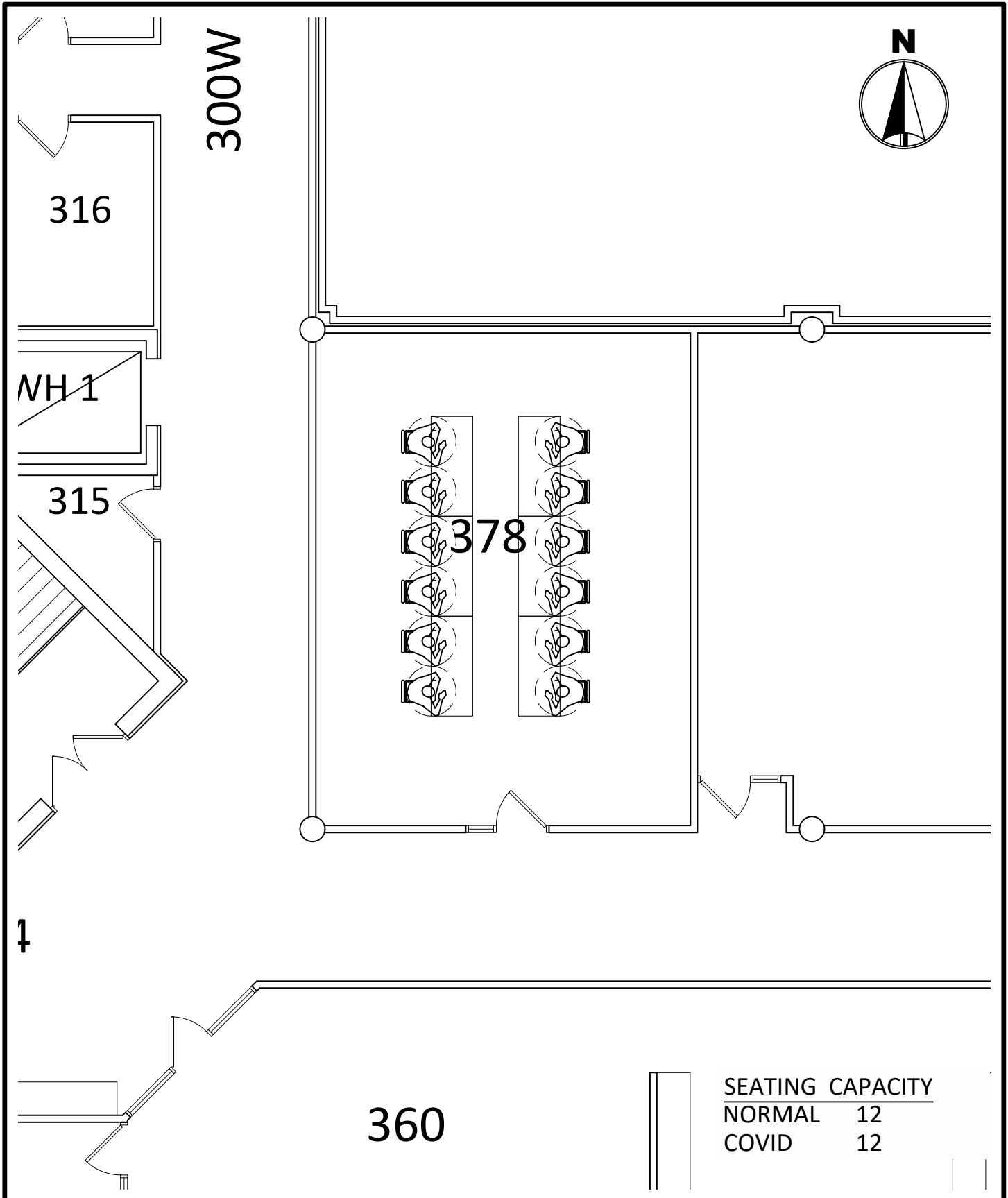

SEATING CAPACITY	
NORMAL	12
COVID	12



**MINNESOTA STATE UNIVERSITY**  
MANKATO  
**PLANNING & CONSTRUCTION**

**WISSINK HALL 378**  
COVID SEATING LAYOUT  
3' SOCIAL DISTANCE

DRAWN BY: N. HUETTL March 2021

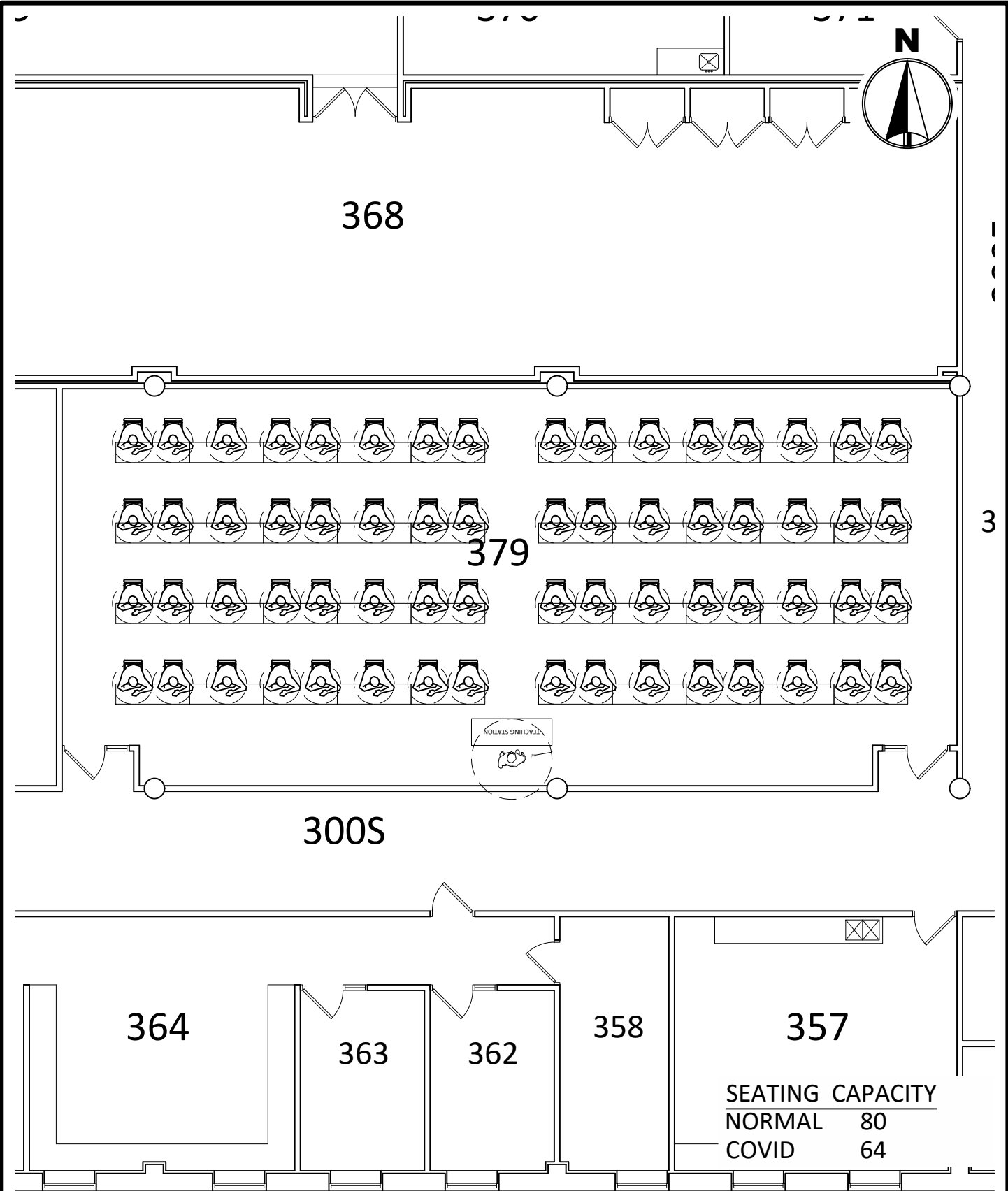

MINNESOTA STATE  
UNIVERSITY  
MANKATO  
PLANNING & CONSTRUCTION

WISSINK HALL 379  
COVID SEATING LAYOUT  
3' SOCIAL DISTANCE

DRAWN BY: N. HUETTL

March 2021